



19/2	Introduction	
	Fuses and Fuse Systems	
19/4	NEOZED Fuse Systems	
19/15	DIAZED Fuse Systems	
19/22	LV HRC Fuse Systems	
19/32	Cylindrical Fuse Systems	
19/35	SITOR 3NE, 3NC Semiconductor Fuses	
19/42	SITOR Fuse Links for Special Applications	
19/43	SILIZED 5SD, 5SE Semiconductor Fuses	
19/44	3ND, 3NW Fuse Links for Motor Circuits	
19/46	American/Canadian Fuses Class CC	
	SR60 Busbar System	
19/47	Busbar Systems	
19/48	Mounting Components	
19/51	Accessories	
	Miniature Circuit-Breakers	
19/52	Introduction	
19/53	Standard Product Range	
19/60	High-Capacity Product Range	
19/70	AC/DC Product Range	
19/71	High-Current Product Range	
19/72	Supplementary Components	
19/77	Accessories	
19/81	Power Supply Company Product Range	
	Residual Current Operated Circuit-Breakers	
19/83	Introduction	
19/84	Residual Current Operated Circuit-Breakers (RCCBs)	
19/90	SIQUENCE RCCBs, AC/DC Sensitive	
19/91	Supplementary Components/ Accessories for RCCBs	
19/95	SIQUENCE RCCBs with Integral Overcurrent Protection (RCBOs), AC/DC Sensitive	
19/96	RCCBs with Integral Overcurrent Protection (RCBOs)	
19/98	Supplementary Components/ Accessories for RCBOs	
19/102	RC Units for Miniature Circuit-Breakers	
19/105	RC Socket Outlets	
19/107	Accessories	
	Lightning and Surge Arresters	
19/108	Introduction	
19/109	Lightning Arresters	
19/110	Combination Arresters	
19/111	Surge Arresters	
19/116	Accessories	
	Power Supply Devices	
19/117	5TE6 8 socket outlets	
	Measuring Devices	
19/118	Introduction	
19/120	7KT5 8 time and pulse counters	
19/121	7KT5 time counters for front mounting	
19/122	7KT1 0 analog measuring devices, 7KT1 1 digital measuring devices	
19/123	7KT1 30 multimeters	
19/124	7KT1 3 multimeters	
19/125	7KT1 14 E-counters, 1-phase	
19/126	7KT1 5 E-counters, 3-phase	
19/127	7KT1 16 E-counters, 3-phase, instabus <i>KNX EIB</i>	
19/128	7KT1 390 LAN couplers, 7KT9 0 measuring selector switches	
19/129	7KT1 2 current transformers	

BETA Modular Installation Devices

Introduction

Overview



Line protection fuses and fuse systems

NEOZED

5SG7 fuse links,
-bases,
-disconnectors

MINIZED 5SG7 switch
disconnectors

DIAZED 5SH

5SF1 fuse links,
-bases



3NH LV HRC fuse links

Fuse links,
-bases,
-signal detectors



3NW cylindrical fuses

Fuse links,
-bases

BETA fuses, fuse systems, busbar systems

Operational classes	gG	gG	gG, gR slow/quick	gG	gG
Rated voltage	V AC 400 V DC 250	400/415 48/110	500/690/750 500/600/750	500/690 250/440	400/500 --
Rated current range	A 2 ... 100	2 ... 63	2 ... 100	2 ... 1250	0,5 ... 100



Standard product range

5SJ6, 5SY6

High-capacity product range

5SY4, 5SY7, 5SY8

AC/DC product range

5SY5



High-current product range

5SP4



Power supply company product range

5SP3

BETA miniature circuit-breakers

Tripping characteristic	V B, C, D	A, B, C, D	B, C	B, C, D	E
Rated currents	A 0,3 ... 63	0,3 ... 80	0,3 ... 63	80 ... 125	16 ... 100
Rated short-circuit capacity	kA 6	10, 15, 25	10	10	25



Lightning arresters
Requirement category B,
1-pole and 3-pole

5SD7

Combination arresters
Requirement category B,
multi-pole

5SD7

Surge arresters
Requirements category C,
1-pole and multi-pole

5SD7

Surge arresters
Requirement category D

5SD7

BETA lightning and surge arresters

Rated voltage	V 230, 400	230, 400	230, 400	230
Surge arrester rated voltage	V 255	255	255 ... 385	255
Discharge capacity	kA 50 ... 100	25 ... 100	15 ... 20	2,5



Time and pulse counters

5KT5

Analog measuring devices

7KT1 0

Digital measuring devices

7KT1 1

Multimeters

7KT1 1

Measuring devices

Application	Monitoring of operating hours and starting operations of devices or plants	Voltage and current measurement, monitoring input and output currents or device currents	Voltage and current measurement, monitoring input and output currents or device currents	For the display and assessment of 23 electrical measured values in switchgear, incoming supplies and outgoing feeders
-------------	--	--	--	---

BETA Modular Installation Devices

Introduction

Semiconductor fuses SITOR 3NE, 3NC LV HRC fuse links, cylindrical fuse links	SITOR for special applications Fuse links	SILIZED 5SD, 5SE NEOZED, DIAZED fuse links	3ND, 3NW fuse links for motor circuits LV HRC fuse links, cylindrical fuse links	American/Canadian fuses Class CC Fuse links and -holders	SR 60 busbar system
gR, aR, gR, gS	aR, gR	gR	aM	Slow/quick/slow, current limiting	--
500 ... 2500 400 ... 700	600 ... 1000 --	400/500 250/500	400/500/690 --	600 300	690 --
1 ... 1000	50 ... 1250	10 ... 100	0,5 ... 630	0,6... 30	Up to 630

Residual current operated circuit- breakers (RCCBs) 5SM3	SIQUENCE residual current operated circuit-breakers (RCCBs), AC/DC sensitive 5SM3	SIQUENCE RCCBs with integral overcurrent protection (RCBOs), AC/DC sensitive 5SU1	RCCBs with integral overcurrent protection (RCBOs) 5SU1	RC units for miniature circuit-breakers 5SM2	RC socket outlets 5SM1, 5SZ9

BETA residual current operated circuit-breakers

Types of current	Type A	Type B	Type B	Type A	Type A	Type A
Rated current A	16 ... 125	25 ... 80	100, 125	6 ... 40	0,3 ... 100	16
Rated residual current mA	10 ... 1000	30, 300	30, 300	10 ... 300	10 ... 1000	10, 30



Socket outlets

5TE6

BETA power supply devices

Application	Power supply for maintenance of distribution boards
-------------	---

Multicounters 7KT1 3	E-counters 7KT1 1, 7KT1 5	LAN couplers 7KT1 390	Measuring selector switches 7KT9 0	Current transformers 7KT1 2
For the display and assessment of 35 electrical measured values and consumption values in switchgear, incoming supplies and outgoing feeders	For the measurement of kWh in 1-phase and 3-phase systems, e.g. in industrial plants, offices and apartments in apartment houses	Worldwide data communica- tion with measuring devices using LAN/Internet	For switching phases for volt- meters and ammeters	For non-contact measuring of primary currents of a 3-phase system

Fuses and Fuse Systems

NEOZED Fuse Systems

Product overview

Overview

Fuse links



- Rated voltage U_n 400 V AC, 250 V DC
- Rated current I_n 2 ... 100 A
- Sizes D01, D02 and D03
- Operational class gG

Fuse bases



- Made of ceramic or molded plastic
- Molded-plastic bases: With touch protection according to BGV A3 (VBG4)
- 1-pole and 3-pole
- Sizes D01 and D02
- Molded-plastic bases: Combined terminal at ingoing and outgoing feeder
- For standard rail mounting
- For busbar mounting

Fuse disconnectors



- Withdrawable design for safe, no-voltage changing of fuse links
- With touch protection according to BGV A2 (VBG4)
- Size D01
- Anti-slip terminal at ingoing and outgoing feeder
- For standard rail mounting
- For busbar mounting
- Sealable knob-operated switch

MINIZED switch disconnectors







- Withdrawable design for safe, no-voltage changing of fuse links
- With touch protection according to BGV A2 (VBG4)
- Sizes D01 and D02
- Combined terminal at ingoing and outgoing feeder
- For standard rail mounting
- For busbar mounting
- Sealable knob-operated switch
- Suitable for switching of loads

Fuses and Fuse Systems

NEOZED Fuse Systems

NEOZED fuse links

Selection and ordering data

Size	I_n	Identification color	Order No.	Price 1 unit	PG	Weight 1 unit approx. kg	PS*/P. unit Unit(s)
Rated voltage 400 V AC/250 V DC, operational class gG							
Consumer packing, package of 10							
	D01	2	Pink	5SE2 302		016	0.006 10 units
		4	Brown	5SE2 304		016	0.006 10 units
		6	Green	5SE2 306		016	0.006 10 units
	D02	10	Red	5SE2 310		016	0.007 10 units
		13	Black	5SE2 013-2A		016	0.007 10 units
		16	Gray	5SE2 316		016	0.007 10 units
	D02	20	Blue	5SE2 320		016	0.012 10 units
		25	Yellow	5SE2 325		016	0.013 10 units
		32	Black	5SE2 332		016	0.014 10 units
	D03	35	Black	5SE2 335		016	0.014 10 units
		40	Black	5SE2 340		016	0.014 10 units
		50	White	5SE2 350		016	0.015 10 units
	D03	63	Copper	5SE2 363		016	0.016 10 units
		80	Silver	5SE2 280		016	0.039 10 units
		100	Red	5SE2 300		016	0.042 10 units
Versions for Italy only (no approvals)							
	D01	20	Blue	5SE2 820		016	0.011 10 units
		25	Yellow	5SE2 825		016	0.012 10 units

* You can order this quantity or a multiple thereof.

Siemens LV 1 · 2006





19/5

Fuses and Fuse Systems

NEOZED Fuse Systems

NEOZED fuse bases

Selection and ordering data





	Size	I_n	Matching cover	Terminals ¹⁾	MW	Order No.	Price 1 unit	PG	Weight 1 unit approx. kg	PS*/P. unit Unit(s)
Molded-plastic fuse bases with touch protection BGV A3 (VBG4)										
	1-pole									
		D01	16	-	FR2	1.5	5SG1 301		016	0.123
	D02	63	-			5SG1 701		016	0.120	1 unit
	3-pole									
		D01	16	-	FR2	4.5	5SG5 301		016	0.371
	D02	63	-			5SG5 701		016	0.360	1 unit
	1-pole									
	With cover									
	D01	16	(A1)	FR0/R	1.5	5SG1 330		016	0.068	6 units
	D02	63	(A1)	FR0/R	1.5	5SG1 730		016	0.087	6 units
	1-pole									
	Without cover									
	D01	16	A1	FR0/R	1.5	5SG1 331		016	0.056	6 units
	D02	63	A1	FR0/R	1.5	5SG1 731		016	0.080	6 units
	3-pole									
	With cover									
	D01	16	(A2)	FR0/R	4.5	5SG5 330		016	0.216	2 units
	D02	63	(A2)	FR0/R	4.5	5SG5 730		016	0.252	2 units

(A1) means that the fuse base is supplied with cover as standard.
A1 means that the fuse base is supplied without cover, the cover can be ordered separately as a spare part.

1) For terminal version, see Catalog ET B1.
FR0/R = incoming/outgoing cable

Fuses and Fuse Systems NEOZED Fuse Systems

NEOZED fuse bases

	Size	I_n	Matching cover	Terminals ¹⁾	MW	Order No.	Price 1 unit	PG	Weight 1 unit approx.	PS*/P. unit	
	A							kg	Unit(s)		
Fuse bases made of ceramic											
1-pole											
	With cover										
		D01	16	(A4)	BB	1.5	5SG1 553		016	0.083	6 units
		D02	63	(A10)	SS	1.5	5SG1 653		016	0.093	6 units
		D02	63	(A10)	KS	1.5	5SG1 693		016	0.090	6 units
	Without cover										
		D01	16	A4	BB	1.5	5SG1 595		016	0.071	6 units
		D02	63	A10	SS	1.5	5SG1 655		016	0.081	6 units
		D02	63	A10	KS	1.5	5SG1 695		016	0.078	6 units
		D03	100	A6, A9	KS	2.5	5SG1 812		016	0.176	1 unit
	For screw connection only, without cover										
		D01	16	A4	BB	1.5	5SG1 590		016	0.061	6 units
		D02	63	A10	SS	1.5	5SG1 650		016	0.078	6 units
		D03	100	A6, A9	KS	2.5	5SG1 810		016	0.176	1 unit
	With cap										
		D01	16	(A8)	BB	1.5	5SG1 594		016	0.105	6 units
		D02	63	(A8)	SS	1.5	5SG1 694		016	0.115	6 units
		D03	100	(A9)	KS	2.5	5SG1 813		016	0.242	1 unit
3-pole											
	With cover										
		D01	16	(A5)	BB	4.5	5SG5 553		016	0.263	2 units
		D02	63	(A11)	SS	4.5	5SG5 653		016	0.240	2 units
		D02	63	(A11)	KS	4.5	5SG5 693		016	0.290	2 units
	Without cover										
		D01	16	A5	BB	4.5	5SG5 555		016	0.228	2 units
		D02	63	A11	SS	4.5	5SG5 655		016	0.265	2 units
		D02	63	A11	KS	4.5	5SG5 695		016	0.255	2 units
	For screw connection only, without cover										
		D01	16	A5	BB	4.5	5SG5 550		016	0.228	2 units
		D02	63	A11	SS	4.5	5SG5 650		016	0.260	2 units
		D02	63	A11	KS	4.5	5SG5 690		016	0.250	2 units

(A4) means that the fuse base is supplied with cover as standard.
A4 means that the fuse base is supplied without cover,
the cover can be ordered separately as a spare part.

1) For terminal version, see Catalog ET B1.

* You can order this quantity or a multiple thereof.

Siemens LV 1 · 2006







19/7

Fuses and Fuse Systems

NEOZED Fuse Systems

NEOZED fuse bases













Accessories

	MW	Order No.	Price 1 unit	PG	Weight 1 unit approx. kg	PS*/ P. unit Unit(s)
NEOZED covers made of molded plastic						
For fuse bases made of molded plastic						
	Cover A1 (for sizes D01, D02), clip-on	1.5	5SH5 244	016	0.008	5 units
	Cover A2 (for sizes D01, D02), clip-on	4.5	5SH5 245	016	0.017	5 units
For fuse bases made of ceramic						
	Cover A4 (for size D01), clip-on	1.5	5SH5 251	016	0.012	5 units
	Cover A10 (for size D02), clip-on	1.5	5SH5 253	016	0.020	5 units
	Cover A5 (for size D01), clip-on	4.5	5SH5 252	016	0.035	1 unit
	Cover A11 (for size D02), clip-on	4.5	5SH5 254	016	0.045	1 unit
	Cover A6 (for size D03), screw-on	2.5	5SH5 233	016	0.021	5 units
NEOZED caps made of molded plastic						
	Cover A8 (for sizes D01, D02), clip-on	–	5SH5 235	016	0.034	5 units
	Cover A9 (for size D03), screw-on	–	5SH5 234	016	0.066	1 unit

Fuses and Fuse Systems

NEOZED Fuse Systems

NEOZED fuse bases

	Size	Length approx. mm	Conductor cross-section mm ²	Load rating up to A	For terminals ¹⁾	MW	Order No.	Price 1 unit	PG	Weight 1 unit approx. kg	PS*/P. unit Unit(s)
Busbars											
The load capacity values are valid for centered infeed.											
Fork-type terminals, non-insulated											
1-pole											
	D01 and D02	1000	20	116	FR0, K	1.5	5SH5 321		016	0.214	1 unit
		1000	36	168	FR0, K	1.5	5SH5 322		016	0.321	1 unit
Fork-type terminals, insulated											
1-pole											
	D01/D02	1000	24	160	FR0, K	1.5	5SH5 517		016	0.550	1 unit
3-pole											
	D01/D02	1000	16	120	FR0, K	1.5	5SH5 320		016	0.843	1 unit
Pins, insulated											
Degree of pollution 2											
1-pole											
	D01/D02	1000	16	130	FR2, S	1.5	5ST3 703		027	0.190	1 unit
3-pole											
	D01/D02	1000	16	120	FR2, S	1.5	5ST3 714		027	0.430	1 unit
End caps for busbars											
	For 5SH5 320						5SH5 514		016	0.001	10 units
	For 5ST3 714						5ST3 750		027	0.001	1 unit
	For 5ST3 701						5ST3 748		027	0.001	1 unit
Busbar adapters											
	For clipping onto busbars 12 mm x 5 mm, with 40 mm center clearance, device width 4.5 MW, with connection cables 3 mm x 16 mm ² for rated current 63 A, for mounting of modular installation devices						5SH5 503		016	0.280	1 unit
	Busbar adapter for clipping onto busbars with 60 mm center clearance, see SR60 busbar system										
Busbar terminals											
Non-insulated, pin-type											
	For conductors from 6 mm ² ... 35 mm ²						5ST2 203		027	0.001	1 unit
Insulated, for clipping onto fork-type or pin-type											
	For conductors from 6 mm ² ... 35 mm ²						5ST2 157		027	0.030	1 unit
Insulated, fork-type											
	For conductors from 6 mm ² ... 25 mm ²						5SH5 328		016	0.014	10 units
Insulated, pin-type											
	For conductors from 2 mm ² ... 25 mm ²						5SH5 327		016	0.014	10 units
	Non-insulated, pin-type						5SH5 326		016	0.016	1 unit
	For two conductors each 2 mm ² ... 16 mm ²										

1) For terminal version, see Catalog ET B1.

* You can order this quantity or a multiple thereof.

Siemens LV 1 · 2006









19/9

19

Fuses and Fuse Systems

NEOZED Fuse Systems

NEOZED fuse bases

Version/size		Order No.	Price 1 unit	PG	Weight 1 unit approx. kg	PS*/ P. unit Unit(s)		
NEOZED screw caps								
	Molded plastic, with inspection hole							
	D01	5SH4 116		016	0.007	10 units		
	D02	5SH4 163		016	0.008	10 units		
	Ceramic							
	D01, sealable	5SH4 316		016	0.014	10 units		
	D02, sealable	5SH4 363		016	0.015	10 units		
	D03	5SH4 100		016	0.070	3 units		
	Ceramic, with inspection hole							
	D01	5SH4 317		016	0.014	10 units		
	D02	5SH4 362		016	0.017	10 units		
Size	For fuse	Identification color	Order No.	Price 1 unit	PG	Weight 1 unit approx. kg	PS*/ P. unit Unit(s)	
Up to A								
NEOZED adapter sleeves								
	D01	2	Pink	5SH5 002		016	0.001	10 units
		4	Brown	5SH5 004		016	0.001	10 units
		6	Green	5SH5 006		016	0.001	10 units
		10/13	Red	5SH5 010		016	0.001	10 units
	D02	20	Blue	5SH5 020		016	0.001	10 units
		25	Yellow	5SH5 025		016	0.001	10 units
		32/35/40	Black	5SH5 035		016	0.001	10 units
		50	White	5SH5 050		016	0.001	10 units
	D03	80	Silver	5SH5 080		016	0.001	10 units
		For adaptation of NEOZED fuse links D01 from 2 A ... 16 A, for insertion in NEOZED bases D02						
	D02	2	Pink	5SH5 402		016	0.001	10 units
		4	Brown	5SH5 404		016	0.001	10 units
		6	Green	5SH5 406		016	0.001	10 units
		10/13	Red	5SH5 410		016	0.001	10 units
		16	Gray	5SH5 416		016	0.001	10 units
	NEOZED adapter sleeve fitters			5SH5 100		016	0.016	1 unit
	NEOZED retaining springs							
	For adapting NEOZED D02 screw caps to insert NEOZED D01 fuse links							
D02	2 ... 16			5SH5 400		016	0.001	25 units
For application in the new German Laender, for adaptation of DL screw caps to insert NEOZED fuse links D01 in DL bases.								
DL	2 ... 16			5SH5 417		016	0.001	25 units

Fuses and Fuse Systems NEOZED Fuse Systems

NEOZED fuse disconnectors

Selection and ordering data

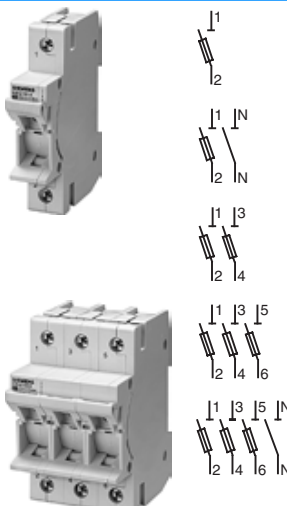
	Number of poles	I_n A	Terminals	MW	Order No.	Price 1 unit	PG	Weight 1 unit approx. kg	PS*/ P. unit Unit(s)
	1	16	FR1	1	5SG7 610		016	0.070	1 unit
	1 + N	16	FR1	2	5SG7 650		016	0.150	1 unit
	2	16	FR1	2	5SG7 620		016	0.150	1 unit
	3	16	FR1	3	5SG7 630		016	0.220	1 unit
	3 + N	16	FR1	4	5SG7 660		016	0.300	1 unit

Accessories

	Size	Length approx. mm	Conductor cross-section mm ²	Load rating up to A	Version	Order No.	Price 1 unit	PG	Weight 1 unit approx. kg	PS*/ P. unit Unit(s)
The load capacity values are valid for centered infeed.										
Fork terminals, insulated										
Degree of pollution 2										
	Busbars, 1-phase									
	D01	220	16	120	With end caps	5ST2 186		027	0.090	1 unit
		1000	16	120		5ST2 190		027	0.500	1 unit
	Busbars, 2-phase									
	D01	220	16	120	With end caps	5ST2 187		027	0.160	1 unit
		1000	16	120		5ST2 191		027	0.710	1 unit
Busbars, 3-phase										
D01	220	16	120	With end caps	5ST2 188		027	0.230	1 unit	
	1000	16	120		5ST2 192		027	1.100	1 unit	
End caps for busbars										
	1-phase					5ST3 748		027	0.001	1 unit
	2-phase and 3-phase					5ST2 197		027	0.001	1 unit

* You can order this quantity or a multiple thereof.

Siemens LV 1 · 2006















19/11

Fuses and Fuse Systems

NEOZED Fuse Systems

MINIZED switch disconnectors







Selection and ordering data

	Number of poles	I_n A	Terminals	MW	Order No.	Price 1 unit	PG	Weight 1 unit approx. kg	PS*/ P. unit Unit(s)
D01, withdrawable design, mounting depth 55 mm									
For standard rail mounting Anti-slip terminal at ingoing and outgoing feeder									
		1	16	R	1	5SG7 713	016	0.080	1 unit
		Version for Italy only (no approvals)				5SG7 713-1B	016	0.080	1 unit
			1 + N	16	R	2	5SG7 753	016	0.150
		Version for Italy only (no approvals)				5SG7 753-1B	016	0.150	1 unit
		2	16	R	2	5SG7 723	016	0.160	1 unit
		Version for Italy only (no approvals)				5SG7 723-1B	016	0.160	1 unit
		3	16	R	3	5SG7 733	016	0.254	1 unit
		Version for Italy only (no approvals)				5SG7 733-1B	016	0.254	1 unit
			3 + N	16	R	4	5SG7 763	016	0.310
		Version for Italy only (no approvals)				5SG7 763-1B	016	0.310	1 unit
D02, draw-out type, mounting depth 70 mm									
For standard rail mounting Neutral conductor leading switch-on, delayed switch-off Anti-slip terminal at ingoing and outgoing feeder									
Enclosure, handle									
<ul style="list-style-type: none"> • Silicone-free, chlorine-free • Temperature resistant up to 140 °C • Self-extinguishing according to UL 94 • Creep resistance CTI 200 									
Fuse holder									
<ul style="list-style-type: none"> • Silicone-free, halogen-free • Temperature resistant up to 150 °C • Self-extinguishing according to UL 94 									
		1	63	FR2	1.5	5SG7 113	016	0.145	1 unit
		Version for Italy only (no approvals)							
			1 + N	63	FR2	3	5SG7 153	016	0.267
		2	63	FR2	3	5SG7 123	016	0.283	1 unit
		Version for Italy only (no approvals)							
		3	63	FR2	4.5	5SG7 133	016	0.421	1 unit
		Versions for Austria only (with permanently installed sleeve inserts, including fuse link)							
			3	25			5SG7 133-8BA25		
				35			5SG7 133-8BA35		
			50			5SG7 133-8BA50			
		3 + N	63	FR2	6	5SG7 163	016	0.540	1 unit

Fuses and Fuse Systems NEOZED Fuse Systems

MINIZED switch disconnectors

Accessories

	Size	Length approx. mm	Conductor cross-section mm ²	Load rating up to A	For terminals ¹⁾	MW	Order No.	Price 1 unit	PG	Weight 1 unit approx. kg	PS*/P. unit Unit(s)	
For MINIZED D01, withdrawable design, mounting depth 55 mm												
	Busbars											
	Pins, insulated, degree of soiling 2, 3-pole											
	D01	1000	16	120	R	1	5ST3 710		027	0.430	1 unit	
	D01	214	16	120	R	1	5ST3 708		027	0.100	1 unit	
	Terminals											
	Not insulated, up to 25 mm ²											
							5SH5 510		016	0.012	1 unit	
	Size	Contact load										
For MINIZED D02, withdrawable design, mounting depth 70 mm												
	Auxiliary switches											
	<ul style="list-style-type: none"> For indicating the switching state of the switch disconnector Can be retrofitted individually with factory-installed clips 											
	1 NO + 1 NC											
	Width 0.5 MW											
	Min. contact load 50 mA, 24 V											
	Max. contact load											
	<ul style="list-style-type: none"> NO contact 											
	AC-14, 2 A, 400 V AC											
	AC-14, 6 A, 230 V AC											
	DC-13, 1 A, 220 V DC											
DC-13, 1 A, 110 V DC												
DC-13, 3 A, 60 V DC												
DC-13, 6 A, 24 V DC												
<ul style="list-style-type: none"> NC contact 												
AC-13, 2 A, 400 V AC												
AC-13, 6 A, 230 V AC												
DC-13, 1 A, 220 V DC												
DC-13, 1 A, 110 V DC												
DC-13, 3 A, 60 V DC												
DC-13, 6 A, 24 V DC												
	Size	Length approx.	Conductor cross-section	Load rating up to	For terminals ¹⁾	MW						
For MINIZED D02, withdrawable design, mounting depth 70 mm												
	Busbars											
	Pins, insulated, degree of pollution 2											
	D02	1000	16	130	FR2	1.5	5ST3 703		027	0.190	1 unit	
	3-pole											
	D02	1000	16	120	FR2	1.5	5ST3 714		027	0.430	1 unit	
	End caps for busbars											
	For 5ST3 708, 5ST3 710, 5ST3 714											
							5ST3 750		027	0.001	1 unit	
	For 5ST3 701											
							5ST3 748		027	0.001	1 unit	

1) For terminal versions, see Catalog ET B1 T.

* You can order this quantity or a multiple thereof.



Siemens LV 1 · 2006

19/13

Fuses and Fuse Systems

NEOZED Fuse Systems

MINIZED switch disconnectors









Size	For fuse Up to A	Identification color	Order No.	Price 1 unit	PG	Weight 1 unit approx. kg	PS*/ P. unit Unit(s)	
Reducers For NEOZED fuse links D01			5SH5 527		016	0.003	10 units	
NEOZED adapter sleeves								
	D01	2	Pink	5SH5 402		016	0.001	10 units
		4	Brown	5SH5 404		016	0.001	10 units
		6	Green	5SH5 406		016	0.001	10 units
		10/13	Red	5SH5 410		016	0.001	10 units
	D02	16	Gray	5SH5 416		016	0.001	10 units
		20	Blue	5SH5 020		016	0.001	10 units
		25	Yellow	5SH5 025		016	0.001	10 units
		32/35/40	Black	5SH5 035		016	0.001	10 units
		50	White	5SH5 050		016	0.001	10 units
	NEOZED adapter keys		5SH5 100		016	0.016	1 unit	

Fuses and Fuse Systems

DIAZED Fuse Systems

DIAZED fuse links

Selection and ordering data

Size	I_n	Identification color	Thread	Order No.	Price 1 unit	PG	Weight 1 unit approx. kg	PS*/P. unit Unit(s)
Rated voltage 500 V AC/500 V DC								
DIN VDE 0635								
Characteristic slow								
	TNDz	2	Pink	E16	5SA2 11		016	10 units
		4	Brown		5SA2 21		016	10 units
		6	Green		5SA2 31		016	10 units
		10	Red		5SA2 51		016	10 units
		16	Gray		5SA2 61		016	10 units
		20	Blue		5SA2 71		016	10 units
		25	Yellow		5SA2 81		016	10 units
Characteristic quick								
	NDz	2	Pink	E16	5SA1 11		016	10 units
		4	Brown		5SA1 21		016	10 units
		6	Green		5SA1 31		016	10 units
		10	Red		5SA1 51		016	10 units
		16	Gray		5SA1 61		016	10 units
		20	Blue		5SA1 71		016	10 units
		25	Yellow		5SA1 81		016	10 units
DIN VDE 0636-301, IEC 60269-3-1								
Operational class gG								
	DII	2	Pink	E27	5SB2 11		016	5 units
		4	Brown		5SB2 21		016	5 units
		6	Green		5SB2 31		016	5 units
		10	Red		5SB2 51		016	5 units
		16	Gray		5SB2 61		016	5 units
		20	Blue		5SB2 71		016	5 units
		25	Yellow		5SB2 81		016	5 units
	DIII	32	Black	E33	5SB4 010		016	5 units
		35	Black		5SB4 11		016	5 units
		50	White		5SB4 21		016	5 units
		63	Copper		5SB4 31		016	5 units
	DIV ¹⁾	80	Silver	R1¼"	5SC2 11		016	3 units
		100	Red		5SC2 21		016	3 units
DIN VDE 0635								
Characteristic quick								
For 5SB1 41, a DIAZED screw adapter for 6 A is used.								
	DII	2	Pink	E27	5SB1 11		016	5 units
		4	Brown		5SB1 21		016	5 units
		6	Green		5SB1 31		016	5 units
		10	Red		5SB1 41		016	5 units
		10	Red		5SB1 51		016	5 units
		16	Gray		5SB1 61		016	5 units
		20	Blue		5SB1 71		016	5 units
	DIII	25	Yellow		5SB1 81		016	5 units
		35	Black	E33	5SB3 11		016	5 units
		50	White		5SB3 21		016	5 units
	DIV	63	Copper		5SB3 31		016	5 units
		80	Silver	R1¼"	5SC1 11		016	3 units
		100	Red		5SC1 21		016	3 units

1) Rated voltage 500 V AC/400 V DC.

* You can order this quantity or a multiple thereof.





Siemens LV 1 · 2006

19/15

Fuses and Fuse Systems

DIAZED Fuse Systems











DIAZED fuse links

Size	I_n	Identification color	Thread	Order No.	Price 1 unit	PG	Weight 1 unit approx.	PS*/P. unit
							kg	Unit(s)
Rated voltage 690 V AC/600 V DC								
DIN VDE 0636-301, IEC 60269-3-1								
Operational class gG, for fuse links 2 A ... 25 A, DIAZED guide screws DII are used.								
	DIII	2	Pink	E33	5SD8 002	016	0.068	5 units
		4	Brown		5SD8 004	016	0.068	5 units
		6	Green		5SD8 006	016	0.068	5 units
		10	Red		5SD8 010	016	0.068	5 units
		16	Gray		5SD8 016	016	0.069	5 units
		20	Blue		5SD8 020	016	0.071	5 units
		25	Yellow		5SD8 025	016	0.072	5 units
		35	Black		5SD8 035	016	0.078	5 units
		50	White		5SD8 050	016	0.080	5 units
		63	Copper		5SD8 063	016	0.082	5 units
Rated voltage 750 V AC/750 V DC								
DIN VDE 0635								
For DC railway systems Characteristic quick, for fuse links 2 A ... 25 A, DIAZED guide screws DII are used.								
	DIII	2	Pink	E33	5SD6 01	016	0.068	5 units
		4	Brown		5SD6 02	016	0.068	5 units
		6	Green		5SD6 03	016	0.068	5 units
		10	Red		5SD6 04	016	0.068	5 units
		16	Gray		5SD6 05	016	0.069	5 units
		20	Blue		5SD6 06	016	0.071	5 units
		25	Yellow		5SD6 07	016	0.072	5 units
		35	Black		5SD6 08	016	0.078	5 units
		50	White		5SD6 10	016	0.080	5 units
		63	Copper		5SD6 11	016	0.082	5 units

Fuses and Fuse Systems DIAZED Fuse Systems

DIAZED fuse bases

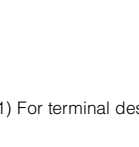
Selection and ordering data

	Size	I_n	Thread	Terminals ¹⁾	Order No.	Price 1 unit	PG	Weight 1 unit approx. kg	PS*/ P. unit Unit(s)
Fuse bases made of ceramic									
Rated voltage 500 V AC/500 V DC (for 690 V AC/600 V DC, size DIII bases are to be used together with DIAZED 5SH1 170 screw caps and DIAZED 5SD8 fuse links)									
1-pole									
		NDz	25	E16	KK	5SF1 012	016	0.060	5 units
		DII	25	E27	BB	5SF1 005	016	0.093	5 units
		DIII	63	E33	BS	5SF1 205	016	0.191	5 units
		DIII	63	E33	SS	5SF1 215	016	0.154	5 units
For screw connection only									
		NDz	25	E16	KK	5SF1 01	016	0.055	5 units
		DII	25	E27	BB	5SF1 024	016	0.093	5 units
		DIII	63	E33	BS	5SF1 224	016	0.137	5 units
		DIII	63	E33	SS	5SF1 214	016	0.141	5 units
		DIV	100	R1¼"	Flat connector	5SF1 401	016	0.380	1 unit
Rated voltage 750 V AC/750 V DC only for DIAZED 5SH1 161 screw caps, only for DIAZED screw adapters DII and DIII, only for DIAZED 5SD6 fuse links, with fine thread, with cap.									
1-pole									
		DIII	63	E33S	KK	5SF4 230	016	0.460	1 unit
Rated voltage 500 V AC/500 V DC (for 690 V AC/600 V DC, size DIII bases are to be used together with DIAZED 5SH1 170 screw caps and DIAZED 5SD8 fuse links)									
3-pole									
	With cap and N-type fixpoint terminal								
		DII	3 × 25	E27	BB	5SF5 067	016	0.400	1 unit
		DIII	3 × 63	E33	BB	5SF5 237	016	0.580	1 unit
For screw connection only, with cap and N-type fixpoint terminal									
		DII	3 × 25	E27	KB	5SF5 066	016	0.410	1 unit
		DIII	3 × 63	E33	KB	5SF5 236	016	0.590	1 unit

1) For terminal designations, see Catalog ET B1 T.

* You can order this quantity or a multiple thereof.









Siemens LV 1 · 2006

19/17

Fuses and Fuse Systems

DIAZED Fuse Systems

DIAZED fuse bases

		Size	I_n	Thread	Terminals ¹⁾	Order No.	Price 1 unit	PG	Weight 1 unit approx. kg	PS*/ P. unit Unit(s)
Fuse bases made of molded plastic										
With touch protection according to BGV A3 (VBG4) Rated voltage 500 V AC/500 V DC for mounting rail or screw connection Anti-slip terminal at ingoing and outgoing feeder Enclosure: Silicone-free Halogen-free Temperature-resistant up to 150 °C Creep resistance CTI 225 According to UL 94										
	1-pole 	DII	25	E27	RR	5SF1 060		016	0.152	3 units
		DIII	63	E33	RR	5SF1 260		016	0.186	3 units
	3-pole 	DII	3 × 25	E27	RR	5SF5 068		016	0.457	1 unit
		DIII	3 × 63	E33	RR	5SF5 268		016	0.538	1 unit
DIAZED bus-mounting bases, EZR										
For clipping onto 5SH3 5 busbars Only for screw connection										
	1-pole 	DII	25	E27	B	5SF6 005		016	0.072	5 units
		DIII	63	E33	B	5SF6 205		016	0.135	5 units
	3-pole 	DII	3 × 25	E27	B	5SF2 07		016	0.351	1 unit











1) For terminal designations, see Catalog ET B1 T.

Fuses and Fuse Systems

DIAZED Fuse Systems

DIAZED fuse bases

Accessories

	Size	Thread	Order No.	Price 1 unit	PG	Weight 1 unit approx. kg	PS*/ P. unit Unit(s)
Mounting parts							
	DIAZED busbars with oblong holes Approx. 1000 mm long						
	Cross-section: 12 mm x 2 mm, load capacity up to 80 A For DII, sufficient for 25 bases		5SH3 500		016	0.095	1 unit
	Cross-section: 13 mm x 3 mm, load capacity up to 120 A For DIII, sufficient for 19 bases		5SH3 501		016	0.180	1 unit
	Terminals, non-insulated Pin, for two conductors from 2 x 1.5 mm ² to 16 mm ²		5SH5 326		016	0.016	1 unit
	Fork-type, for conductors up to 35 mm ²		5SH3 502		016	0.010	10 units
	Busbars for DIAZED EZR bus-mounting bases Suitable for fork-type terminal connection, ready-made drilling with thread for screw adapters, approx. 2000 mm long Cross-section: 16 mm x 3 mm, load capacity up to 150 A For lateral incoming supply						
	For DII	Sufficient for 42 5SF6 005 bases	5SH3 54		016	0.740	1 unit
	For DII and DIII	Sufficient for 34 5SF6 205 bases	5SH3 55		016	0.740	1 unit
	For DII	Sufficient for 27 5SF2 07 bases	5SH3 56		016	0.740	1 unit
	EZR bus-mounting terminals Non-insulated						
	For conductors up to 16 mm ²		8JH4 122		046	0.012	1 unit
	For conductors up to 35 mm ²		8JH4 124		046	0.024	1 unit
DIAZED covers							
	DIAZED covers Molded plastic Not suitable for SILIZED fuse links						
	1-pole (5 DIAZED bases = 12 MW) DII E27		5SH2 032		016	0.017	10 units
	(4 DIAZED bases = 12 MW) DIII E33		5SH2 232		016	0.020	10 units
	Caps Molded plastic 1-pole						
	NDz	E16	5SH2 01		016	0.028	5 units
	DII	E27	5SH2 02		016	0.038	5 units
	DIII	E33	5SH2 22		016	0.048	5 units
	Cover rings 1-pole						
	Molded plastic Also for bus-mounting base EZR						
	DII	E27	5SH3 401		016	0.013	5 units
	DIII	E33	5SH3 411		016	0.014	5 units
	Ceramic DII and DIII also for bus-mounting base EZR						
	NDz	E16	5SH3 30		016	0.020	5 units
	DII	E27	5SH3 32		016	0.029	10 units
	DIII	E33	5SH3 34		016	0.035	10 units

* You can order this quantity or a multiple thereof.







Siemens LV 1 - 2006

19/19

Fuses and Fuse Systems

DIAZED Fuse Systems

DIAZED fuse bases







Size	Thread	For fuse links	Order No.	Price 1 unit	PG	Weight 1 unit approx.	PS*/P. unit
		A				kg	Unit(s)
Screw adapters, adapter sleeves							
DIAZED screw adapters							
	NDz	E16	2	5SH3 28		016	0.002 10 units
			4	5SH3 31		016	0.002 10 units
			6	5SH3 05		016	0.002 10 units
			10	5SH3 06		016	0.002 10 units
			16	5SH3 07		016	0.002 10 units
Also for mounting in DIAZED base DIII							
	DII ¹⁾	E27	2	5SH3 10		016	0.015 10 units
			4	5SH3 11		016	0.015 10 units
			6	5SH3 12		016	0.015 10 units
			10	5SH3 13		016	0.015 10 units
			16	5SH3 14		016	0.014 10 units
20	5SH3 15		016	0.012 10 units			
	DIII ¹⁾	E33	25	5SH3 16		016	0.012 10 units
			35	5SH3 17		016	0.019 10 units
			50	5SH3 18		016	0.018 10 units
			63	5SH3 20		016	0.017 10 units
DIAZED adapter sleeves for DIV bases							
	DIV	R1¼"	80	5SH3 21		016	0.006 10 units
			100	5SH3 22		016	0.005 10 units
	For snapping onto DIAZED screw caps, if E16 DIAZED fuse links are inserted in DII DIAZED bases			5SH3 01		016	0.012 10 units
	if DII DIAZED fuse links are inserted in DIII DIAZED bases			5SH3 02		016	0.023 10 units
DIAZED adapter sleeve fitters for DII/DIII				5SH3 703		016	0.025 1 unit
							

1) Suitable for a rated voltage of up to 750 V.

Fuses and Fuse Systems

DIAZED Fuse Systems

DIAZED fuse bases

Size	I_n	Thread	Order No.	Price 1 unit	PG	Weight 1 unit approx. kg	PS*/ P. unit Unit(s)
DIAZED screw caps							
Rated voltage 500 V AC/500 V DC							
	Ceramic NDz	25	E16	5SH1 11		016 0.016	5 units
	Molded plastic, with inspection hole, black, not for SILIZED fuse links DII	25	E27	5SH1 221		016 0.026	5 units
	DIII	63	E33	5SH1 231		016 0.042	5 units
	Narrow version, ceramic DII	25	E27	5SH1 12		016 0.034	5 units
	DIII	63	E33	5SH1 13		016 0.059	5 units
	Mushroom shape, ceramic, with inspection hole, sealable DII	25	E27	5SH1 22		016 0.050	5 units
	DIII	63	E33	5SH1 23		016 0.080	5 units
	Ceramic DIV	100	R1¼"	5SH1 141		016 0.181	1 unit
Rated voltage 750 V AC/750 V DC							
	Only for 5SD6 DIAZED fuse links and 5SF4 230 DIAZED fuse bases Ceramic, with fine thread DIII	63	E33S	5SH1 161		016 0.084	1 unit
Rated voltage 690 V AC/600 V DC							
	Only for 5SD8 DIAZED fuse links Ceramic, extended version DIII	63	E33	5SH1 170		016 0.086	1 unit

* You can order this quantity or a multiple thereof.

Siemens LV 1 · 2006





19/21

Fuses and Fuse Systems

LV HRC Fuse Systems

LV HRC fuse links gG





Selection and ordering data

Size	Width mm	I_n A	U_n V	Insulated grip lugs		PG	Weight 1 unit approx. kg	PS*/ P. unit Unit(s)
				Order No.	Price 1 unit			
LV HRC fuse links with integrated indicator, operational class gG								
LV HRC fuse links of size 000 can also be used in LV HRC fuse bases, LV HRC fuse switch disconnectors, LV HRC fuse strips as well as LV HRC in-line fuse switch disconnectors of size 00.								
	000	21	10	400 V AC	3NA6 803-4	013	0.135	3 units
					3NA6 805-4	013	0.135	3 units
					3NA6 807-4	013	0.135	3 units
					3NA6 810-4	013	0.135	3 units
					3NA6 812-4	013	0.135	3 units
					3NA6 814-4	013	0.135	3 units
					3NA6 817-4	013	0.135	3 units
					3NA6 820-4	013	0.135	3 units
					3NA6 822-4	013	0.135	3 units
					3NA6 824-4	013	0.135	3 units
3NA6 830-4	013	0.135	3 units					
	00	30	80	400 V AC	3NA6 824-4KK	013	0.200	3 units
					3NA6 830-4KK	013	0.200	3 units
					3NA6 832-4	013	0.200	3 units
					3NA6 836-4	013	0.200	3 units
	1	30	35	400 V AC	3NA6 114-4	013	0.290	3 units
					3NA6 117-4	013	0.290	3 units
					3NA6 120-4	013	0.290	3 units
					3NA6 122-4	013	0.290	3 units
					3NA6 124-4	013	0.290	3 units
					3NA6 130-4	013	0.290	3 units
					3NA6 132-4	013	0.290	3 units
					3NA6 136-4	013	0.290	3 units
					3NA6 140-4	013	0.430	3 units
					3NA6 142-4	013	0.430	3 units
3NA6 144-4	013	0.430	3 units					
	2	47.2	50	400 V AC	3NA6 220-4	013	0.450	3 units
					3NA6 222-4	013	0.450	3 units
					3NA6 224-4	013	0.450	3 units
					3NA6 230-4	013	0.450	3 units
					3NA6 232-4	013	0.450	3 units
					3NA6 236-4	013	0.450	3 units
					3NA6 240-4	013	0.450	3 units
					3NA6 242-4	013	0.450	3 units
					3NA6 244-4	013	0.450	3 units
					3NA6 250-4	013	0.650	3 units
					3NA6 252-4	013	0.650	3 units
					3NA6 254-4	013	0.650	3 units
					3NA6 260-4	013	0.650	3 units

Fuses and Fuse Systems

LV HRC Fuse Systems

LV HRC fuse links gG

Size	Width mm	I_n A	U_n V	Non-insulated grip lugs		Insulated grip lugs		PG	Weight 1 unit approx. kg	PS*/ P. unit Unit(s)	
				Order No.	Price 1 unit	Order No.	Price 1 unit				
LV HRC fuse links with integrated indicator, operational class gG											
LV HRC fuse links of size 000 can also be used in LV HRC fuse bases, LV HRC fuse switch disconnectors, LV HRC fuse strips as well as LV HRC in-line fuse switch disconnectors of size 00.											
The 300 A and 355 A fuse links do not have VDE marking. They comply with the standard but are not allowed to bear the test mark.											
	000	21	2	500 V AC/ 250 V DC	3NA7 802		3NA6 802		013	0.135	3 units
			4		3NA7 804		3NA6 804		013	0.135	3 units
			6		3NA7 801		3NA6 801		013	0.135	3 units
			10		3NA7 803		3NA6 803		013	0.136	3 units
			16		3NA7 805		3NA6 805		013	0.136	3 units
			20		3NA7 807		3NA6 807		013	0.136	3 units
			25		3NA7 810		3NA6 810		013	0.136	3 units
			32		3NA7 812		3NA6 812		013	0.136	3 units
			35		3NA7 814		3NA6 814		013	0.136	3 units
			40		3NA7 817		3NA6 817		013	0.136	3 units
			50		3NA7 820		3NA6 820		013	0.136	3 units
63		3NA7 822		3NA6 822		013	0.136	3 units			
80		3NA7 824		3NA6 824		013	0.136	3 units			
100		3NA7 830		3NA6 830		013	0.136	3 units			
	00	30	80	500 V AC/ 250 V DC	3NA7 824-7		3NA6 824-7		013	0.211	3 units
			100		3NA7 830-7		3NA6 830-7		013	0.211	3 units
			125		3NA7 832		3NA6 832		013	0.211	3 units
			160		3NA7 836		3NA6 836		013	0.211	3 units
	1	30	16	500 V AC/ 440 V DC	3NA7 105		3NA6 105		013	0.290	3 units
			20		3NA7 107		3NA6 107		013	0.290	3 units
			25		3NA7 110		3NA6 110		013	0.290	3 units
			35		3NA7 114		3NA6 114		013	0.290	3 units
			40		3NA7 117		3NA6 117		013	0.290	3 units
			50		3NA7 120		3NA6 120		013	0.290	3 units
			63		3NA7 122		3NA6 122		013	0.290	3 units
			80		3NA7 124		3NA6 124		013	0.290	3 units
			100		3NA7 130		3NA6 130		013	0.290	3 units
			125		3NA7 132		3NA6 132		013	0.290	3 units
			160		3NA7 136		3NA6 136		013	0.290	3 units
47.2		200		3NA7 140		3NA6 140		013	0.440	3 units	
		224		3NA7 142		3NA6 142		013	0.440	3 units	
		250		3NA7 144		3NA6 144		013	0.440	3 units	
	2	47.2	35	500 V AC/ 440 V DC	3NA7 214		3NA6 214		013	0.450	3 units
			50		3NA7 220		3NA6 220		013	0.450	3 units
			63		3NA7 222		3NA6 222		013	0.450	3 units
			80		3NA7 224		3NA6 224		013	0.450	3 units
			100		3NA7 230		3NA6 230		013	0.450	3 units
			125		3NA7 232		3NA6 232		013	0.450	3 units
			160		3NA7 236		3NA6 236		013	0.450	3 units
			200		3NA7 240		3NA6 240		013	0.450	3 units
			224		3NA7 242		3NA6 242		013	0.450	3 units
			250		3NA7 244		3NA6 244		013	0.450	3 units
			57.8		300		--		3NA6 250		013
		315		3NA7 252		3NA6 252		013	0.660	3 units	
		355		--		3NA6 254		013	0.641	3 units	
		400		3NA7 260		3NA6 260		013	0.660	3 units	

* You can order this quantity or a multiple thereof.





Siemens LV 1 · 2006

19/23

Fuses and Fuse Systems

LV HRC Fuse Systems

LV HRC fuse links gG





Size	Width mm	I_n A	U_n V	Non-insulated grip lugs		Insulated grip lugs		PG	Weight 1 unit approx. kg	PS*/ P. unit Unit(s)
				Order No.	Price 1 unit	Order No.	Price 1 unit			
LV HRC fuse links with integrated indicator, operational class gG										
LV HRC fuse links of size 000 can also be used in LV HRC fuse bases, LV HRC fuse switch disconnectors, LV HRC fuse strips as well as LV HRC in-line fuse switch disconnectors of size 00.										
The 300 A fuse links do not have VDE marking. They comply with the standard but are not allowed to bear the test mark.										
	21	2	690 V AC/ 250 V DC	3NA7 802-6		3NA6 802-6		013	0.136	3 units
		4		3NA7 804-6		3NA6 804-6		013	0.136	3 units
		6		3NA7 801-6		3NA6 801-6		013	0.136	3 units
		10		3NA7 803-6		3NA6 803-6		013	0.136	3 units
		16		3NA7 805-6		3NA6 805-6		013	0.136	3 units
		20		3NA7 807-6		3NA6 807-6		013	0.136	3 units
		25		3NA7 810-6		3NA6 810-6		013	0.136	3 units
	30	40	690 V AC/ 250 V DC	3NA7 817-6		3NA6 817-6		013	0.211	3 units
		50		3NA7 820-6		3NA6 820-6		013	0.211	3 units
		63		3NA7 822-6		3NA6 822-6		013	0.211	3 units
		80		3NA7 824-6		3NA6 824-6		013	0.211	3 units
		100		3NA7 830-6		3NA6 830-6		013	0.211	3 units
	30	50	690 V AC/ 440 V DC	3NA7 120-6		3NA6 120-6		013	0.290	3 units
		63		3NA7 122-6		3NA6 122-6		013	0.290	3 units
		80		3NA7 124-6		3NA6 124-6		013	0.290	3 units
		100		3NA7 130-6		3NA6 130-6		013	0.290	3 units
		125		3NA7 132-6		3NA6 132-6		013	0.290	3 units
		160		3NA7 136-6		3NA6 136-6		013	0.290	3 units
		47.2		200	3NA7 140-6		3NA6 140-6		013	0.440
	47.2	80	690 V AC/ 440 V DC	3NA7 224-6		3NA6 224-6		013	0.450	3 units
		100		3NA7 230-6		3NA6 230-6		013	0.450	3 units
		125		3NA7 232-6		3NA6 232-6		013	0.450	3 units
	160	3NA7 236-6			3NA6 236-6		013	0.450	3 units	
	200	3NA7 240-6			3NA6 240-6		013	0.450	3 units	
	57.8	224		3NA7 242-6		3NA6 242-6		013	0.660	3 units
		250		3NA7 244-6		3NA6 244-6		013	0.660	3 units
		300		3NA7 250-6		3NA6 250-6		013	0.660	3 units
		315		3NA7 252-6		3NA6 252-6		013	0.660	3 units

Further versions on request.

Fuses and Fuse Systems

LV HRC Fuse Systems

LV HRC fuse links gG

Size	Width mm	I_n A	U_n V	Non-insulated grip lugs		PG	Weight 1 unit approx. kg	PS*/ P. unit Unit(s)
				Order No.	Price 1 unit			
LV HRC fuse links with front indicator, operational class gG								
LV HRC fuse links of size 000 can also be used in LV HRC fuse bases, LV HRC fuse switch disconnectors, LV HRC fuse strips as well as LV HRC in-line fuse switch disconnectors of size 00								
	000	21	2 4 6 10 16 20 25 32 35 40 50 63 80 100	500 V AC/ 250 V DC	3NA3 802	013	0.133	3 units
					3NA3 804	013	0.133	3 units
					3NA3 801	013	0.133	3 units
					3NA3 803	013	0.133	3 units
					3NA3 805	013	0.133	3 units
					3NA3 807	013	0.133	3 units
					3NA3 810	013	0.133	3 units
					3NA3 812	013	0.133	3 units
					3NA3 814	013	0.133	3 units
					3NA3 817	013	0.133	3 units
					3NA3 820	013	0.133	3 units
					3NA3 822	013	0.133	3 units
	00	30	35 50 63 80 100 125 160	500 V AC/ 250 V DC	3NA3 814-7	013	0.200	3 units
					3NA3 820-7	013	0.200	3 units
					3NA3 822-7	013	0.200	3 units
					3NA3 824-7	013	0.200	3 units
					3NA3 830-7	013	0.200	3 units
					3NA3 832	013	0.217	3 units
	0	30	6 10 16 20 25 32 35 40 50 63 80 100 125 160	500 V AC/ 440 V DC	3NA3 001	013	0.340	3 units
					3NA3 003	013	0.340	3 units
					3NA3 005	013	0.340	3 units
					3NA3 007	013	0.340	3 units
					3NA3 010	013	0.340	3 units
					3NA3 012	013	0.340	3 units
					3NA3 014	013	0.340	3 units
					3NA3 017	013	0.340	3 units
					3NA3 020	013	0.340	3 units
					3NA3 022	013	0.340	3 units
					3NA3 024	013	0.340	3 units
					3NA3 030	013	0.340	3 units
					3NA3 032	013	0.340	3 units
					3NA3 036	013	0.340	3 units
	1	30	16 20 25 35 40 50 63 80 100 125 160 200 224 250	500 V AC/ 440 V DC	3NA3 105	013	0.290	3 units
					3NA3 107	013	0.290	3 units
					3NA3 110	013	0.290	3 units
					3NA3 114	013	0.300	3 units
					3NA3 117	013	0.300	3 units
					3NA3 120	013	0.300	3 units
					3NA3 122	013	0.300	3 units
					3NA3 124	013	0.300	3 units
					3NA3 130	013	0.300	3 units
					3NA3 132	013	0.300	3 units
					3NA3 136	013	0.300	3 units
					3NA3 140	013	0.440	3 units
					3NA3 142	013	0.440	3 units
					3NA3 144	013	0.440	3 units

* You can order this quantity or a multiple thereof.





Siemens LV 1 · 2006

19/25

Fuses and Fuse Systems

LV HRC Fuse Systems





LV HRC fuse links gG

Size	Width mm	I_n A	U_n V	Non-insulated grip lugs		PG	Weight 1 unit approx. kg	PS*/ P. unit Unit(s)
				Order No.	Price 1 unit			
LV HRC fuse links with front indicator, operational class gG								
The 300 A, 355 A and 425 A fuse links do not have VDE marking. They comply with the standard but are not allowed to bear the test mark. Fuse links, size 4a can only be installed in 3NH7 520 LV HRC fuse base, size 4a.								
	2	47.2	35 50 63 80 100 125 160 200 224 250	500 V AC/ 440 V DC	3NA3 214	013	0.453	3 units
					3NA3 220	013	0.453	3 units
					3NA3 222	013	0.453	3 units
					3NA3 224	013	0.453	3 units
					3NA3 230	013	0.453	3 units
					3NA3 232	013	0.453	3 units
					3NA3 236	013	0.453	3 units
					3NA3 240	013	0.453	3 units
					3NA3 242	013	0.453	3 units
					3NA3 244	013	0.453	3 units
					3NA3 250	013	0.647	3 units
					3NA3 252	013	0.647	3 units
					3NA3 254	013	0.647	3 units
3NA3 260	013	0.647	3 units					
	3	57.8	200 224 250 300 315 355 400	500 V AC/ 440 V DC	3NA3 340	013	0.647	3 units
					3NA3 342	013	0.640	3 units
					3NA3 344	013	0.647	3 units
					3NA3 350	013	0.647	3 units
					3NA3 352	013	0.647	3 units
					3NA3 354	013	0.647	3 units
					3NA3 360	013	0.647	3 units
					3NA3 362	013	1.000	3 units
					3NA3 365	013	1.000	3 units
					3NA3 372	013	1.000	3 units
	4 (IEC design)	101.8	630 800 1000 1250	500 V AC/ 440 V DC	3NA3 472	013	2.500	1 unit
					3NA3 475	013	2.500	1 unit
					3NA3 480	013	2.500	1 unit
					3NA3 482	013	2.500	1 unit
	4a	101.8	500 630 800 1000 1250	500 V AC/ 440 V DC	3NA3 665	013	2.700	1 unit
					3NA3 672	013	2.700	1 unit
					3NA3 675	013	2.700	1 unit
					3NA3 680	013	2.840	1 unit
					3NA3 682	013	2.840	1 unit

Fuses and Fuse Systems

LV HRC Fuse Systems

LV HRC fuse links gG

Size	Width mm	I_n A	U_n V	Non-insulated grip lugs		PG	Weight 1 unit approx. kg	PS*/ P. unit Unit(s)
				Order No.	Price 1 unit			
LV HRC fuse links with front indicator, operational class gG								
The 300 A and 425 A fuse links do not have VDE marking. They comply with the standard but are not allowed to bear the test mark.								
	000	21	2 4 6 10 16 20 25 32 35	690 V AC/ 250 V DC	3NA3 802-6	013	0.135	3 units
					3NA3 804-6	013	0.135	3 units
					3NA3 801-6	013	0.135	3 units
					3NA3 803-6	013	0.135	3 units
					3NA3 805-6	013	0.135	3 units
					3NA3 807-6	013	0.135	3 units
					3NA3 810-6	013	0.135	3 units
					3NA3 812-6	013	0.135	3 units
	00	30	40 50 63 80 100	690 V AC/ 250 V DC	3NA3 817-6	013	0.200	3 units
					3NA3 820-6	013	0.200	3 units
					3NA3 822-6	013	0.200	3 units
					3NA3 824-6	013	0.200	3 units
					3NA3 830-6	013	0.200	3 units
	1	30	50 63 80 100 125 160 200	690 V AC/ 440 V DC	3NA3 120-6	013	0.290	3 units
					3NA3 122-6	013	0.290	3 units
					3NA3 124-6	013	0.290	3 units
					3NA3 130-6	013	0.290	3 units
					3NA3 132-6	013	0.290	3 units
					3NA3 136-6	013	0.290	3 units
					3NA3 140-6	013	0.426	3 units
						2	47.2	80 100 125 160 200
3NA3 230-6	013	0.426	3 units					
3NA3 232-6	013	0.426	3 units					
3NA3 236-6	013	0.426	3 units					
3NA3 240-6	013	0.426	3 units					
3NA3 242-6	013	0.660	3 units					
57.8	224 250 300 315	690 V AC/ 440 V DC	3NA3 244-6	013			0.680	3 units
			3NA3 250-6	013			0.660	3 units
			3NA3 252-6	013			0.680	3 units
	3	57.8	250 315	690 V AC/ 440 V DC	3NA3 344-6	013	0.660	3 units
					3NA3 352-6	013	0.660	3 units
		71.2	355 400 425 500	690 V AC/ 440 V DC	3NA3 354-6	013	1.000	3 units
					3NA3 360-6	013	1.000	3 units
					3NA3 362-6	013	1.000	3 units
					3NA3 365-6	013	1.000	3 units

* You can order this quantity or a multiple thereof.

Siemens LV 1 · 2006



19/27

Fuses and Fuse Systems

LV HRC Fuse Systems

LV HRC fuse bases

Selection and ordering data







Size	I_n	Version	Order No.	Price 1 unit	PG	Weight 1 unit approx. kg	PS*/ P. unit Unit(s)		
LV HRC fuse bases									
	000/00	160	1-pole With flat connectors, screw With plug-in connectors With saddle-type connectors	3NH3 030 3NH3 031 3NH3 032		014 0.235 014 0.230 014 0.266	3 units 3 units 3 units		
			160	With flat connectors and terminal strip With flat connectors, nut With flat and saddle-type connector	3NH3 035 3NH3 038 3NH3 050		014 0.230 014 0.207 014 0.227	3 units 3 units 3 units	
				160	Molded plastic, for standard rail mounting and screw fixing				
	With flat connectors, screw With saddle-type connectors	3NH3 051 3NH3 052				014 0.160 014 0.190	1 unit 1 unit		
		125	With box terminal, up to 50 mm ²	3NH3 053		014 0.155	1 unit		
		160	3-pole, with phase barriers With flat connectors With plug-in connectors With saddle-type connectors	3NH4 030 3NH4 031 3NH4 032		014 0.700 014 0.800 014 0.800	1 unit 1 unit 1 unit		
			With flat connectors and terminal strip	3NH4 035		014 0.750	1 unit		
			0	160	1-pole With flat connectors With plug-in connectors	3NH3 120 3NH3 122		014 0.460 014 0.460	3 units 3 units
					1	250	1-pole With flat connectors With twin busbar connectors	3NH3 230 3NH3 220	
	1	250	3-pole With flat connectors	3NH4 230				014 2.100	1 unit
2			400	1-pole With flat connectors With twin busbar connectors	3NH3 330 3NH3 320		014 0.843 014 1.000	1 unit 1 unit	
	3	630		1-pole With flat connectors With twin busbar connectors	3NH3 430 3NH3 420		014 1.100 014 1.100	1 unit 1 unit	
4 (IEC design)			1250	1-pole With flat connectors	3NH3 530		014 3.000	1 unit	

* You can order this quantity or a multiple thereof.

Fuses and Fuse Systems

LV HRC Fuse Systems

LV HRC fuse bases

Size	I_n	Version	Order No.	Price 1 unit	PG	Weight 1 unit approx. kg	PS*/ P. unit Unit(s)	
LV HRC bus-mounting bases for busbars								
For busbars 12 mm x 5 mm to 12 mm x 10 mm Busbar clearance 40 mm								
	000/00	160	1-pole With quick-connect terminal at top at bottom Terminal strip at top	3NH3 036		014	0.150	1 unit
				3NH3 037		014	0.150	1 unit
				3NH3 048		014	0.150	1 unit
	000/00	80	3-pole, tandem design 3 outgoing feeders each at top and bottom with saddle-type connector With 4 phase barriers With 2 non-interrupted barriers	3NH4 037		014	0.800	1 unit
				3NH4 045		014	0.800	1 unit
LV HRC fuse bases with slewing equipment								
Degree of pollution 3 Degree of protection: open IP10, closed IP20 1-pole, with flat connector								
	000/00	160	Supplied with additional saddle-type connectors With screw fixing for mounting plate With claw fixing for non-perforated busbar With screw fixing for perforated busbar	3NH7 030		014	1.000	1 unit
				3NH7 031		014	1.000	1 unit
				3NH7 032		014	1.000	1 unit
	1	250	With screw fixing for mounting plate With claw fixing for non-perforated busbar With screw fixing for perforated busbar	3NH7 230		014	2.500	1 unit
				3NH7 231		014	2.500	1 unit
				3NH7 232		014	2.500	1 unit
	2/3	400 and 630	With screw fixing for mounting plate With claw fixing for non-perforated busbar With screw fixing for perforated busbar can be used as disconnecter	3NH7 330		014	4.800	1 unit
				3NH7 331		014	4.800	1 unit
				3NH7 332		014	4.800	1 unit
	4a	1250	With screw fixing for mounting plate	3NH7 520		014	5.200	1 unit

* You can order this quantity or a multiple thereof.







Siemens LV 1 · 2006

19/29

Fuses and Fuse Systems

LV HRC Fuse Systems

LV HRC fuse bases





	Size	Order No.	Price 1 unit	PG	Weight 1 unit approx. kg	PS*/ P. unit Unit(s)
Mounting parts for LV HRC fuse bases						
	LV HRC contact covers Touch protection for contact pieces					
	000/00	3NX3 105		014	0.013	2 units
	0	3NX3 114		014	0.010	2 units
	1	3NX3 106		014	0.027	2 units
	2	3NX3 107		014	0.031	2 units
	3	3NX3 108		014	0.038	2 units
	LV HRC barriers For side-by-side mounting of LV HRC fuse bases and as end barrier for side-by-side arrangement					
	Type					
	000/00	3NX2 023		014	0.025	2 units
	3NH3 0/3NH4 0	3NX2 030		014	0.050	2 units
	3NH3 1	3NX2 024		014	0.053	2 units
	3NH3 2	3NX2 025		014	0.066	2 units
	2	3NX2 025		014	0.066	2 units
	3	3NX2 026		014	0.101	2 units
	LV HRC protective covers IP2X For LV HRC fuse bases, size 000/00 1-pole and 3-pole					
		3NX3 115		014	0.039	1 unit
	LV HRC covers IP2X For LV HRC protective cover IP2X					
		3NX3 116		014	0.014	1 unit
Mounting parts for LV HRC bus-mounting bases						
	LV HRC contact covers For mounting onto contacts to ensure touch protection					
		3NX3 105		014	0.013	2 units
		3NX3 113		014	0.006	2 units
	LV HRC barriers For 3NH3 0 LV HRC rail mounting fuse bases Phase barrier					
		3NX2 027		014	0.017	2 units
	End barrier					
		3NX2 028		014	0.020	2 units
	For 3NH4 0 LV HRC rail-mounting fuse base in tandem design Non-interrupted phase barrier					
		3NX2 031		014	0.050	2 units

Fuses and Fuse Systems



LV HRC Fuse Systems

LV HRC bases
LV HRC signal detectors

Selection and ordering data

	Size	Order No.	Price 1 unit	PG	Weight 1 unit approx. kg	PS*/ P. unit Unit(s)			
Mounting parts for LV HRC fuse links									
	000 to 4	Fuse pullers For LV HRC fuse links							
		Without sleeve	3NX1 013				014	0.280	1 unit
		With sleeve	3NX1 014	014	0.480	1 unit			
Isolating links For LV HRC fuse bases and fuse switch disconnectors									
	000/00 0 1 2 3	With insulated grip lugs							
		Silver-plated	3NG1 002				014	0.080	1 unit
			3NG1 102				014	0.110	1 unit
			3NG1 202				014	0.170	1 unit
			3NG1 302				014	0.240	1 unit
	4 4a	With non-insulated grip lugs							
		Tin-plated	3NG1 503				014	0.708	1 unit
		Nickel-plated	3NG1 505				014	0.730	1 unit
Fuse-base covers For LV HRC fuse bases According to DIN 43620 Red with yellow information label "Power Supply Isolating Point"									
	000/00 1, 2, 3								
			3NX1 003				014	0.050	3 units
			3NX1 004	014	0.100	3 units			

For LV HRC fuse switch disconnectors, see [Switching and Protection Devices, Switch Disconnectors](#).

	Size	Order No.	Price 1 unit	PG	Weight 1 unit approx. kg	PS*/ P. unit Unit(s)
LV HRC signal detectors For LV HRC fuse links with non-insulated grip lugs						
	000 to 4	<ul style="list-style-type: none"> Rated voltage up to 690 V AC/600 V DC Contact: microswitch 250 V AC, 6 A Connection: flat connector 2.3 mm ... 0.5 mm 				
			3NX1 021			
Signal detector links • Rated voltage up to 690 V AC/600 V DC Response value > 9 V; 2.5 A; for standard applications Response value > 2 V; 7 A; only for meshed systems						
	000 to 4					
			3NX1 022			
			3NX1 023	014	0.015	1 unit
Signal detector attachments For LV HRC fuse links with non-insulated or insulated grip lugs						
	000 to 2	<ul style="list-style-type: none"> Rated voltage up to 690 V AC/600 V DC Contact: microswitch 230 V AC, 5 A, 1 CO contact Connection: flat connector 2.3 mm 				
			3NX1 024			





* You can order this quantity or a multiple thereof.

Fuses and Fuse Systems

Cylindrical Fuse Systems

Cylindrical fuse links gG

Selection and ordering data









































Size	I_n	U_n	Operational class gG		PG	Weight 1 unit approx.	PS*/ P. unit
			Order No.	Price 1 unit			
mm × mm	A	V AC				kg	Unit(s)
Cylindrical fuse links							
	2	400	3NW6 302-1		018	0.004	10 units
	4		3NW6 304-1		018	0.004	10 units
	6		3NW6 301-1		018	0.004	10 units
	10		3NW6 303-1		018	0.004	10 units
	16		3NW6 305-1		018	0.004	10 units
	20		3NW6 307-1		018	0.004	10 units
	2	500	3NW6 002-1		018	0.008	10 units
	4		3NW6 004-1		018	0.008	10 units
	6		3NW6 001-1		018	0.008	10 units
	8		3NW6 008-1		018	0.008	10 units
	10		3NW6 003-1		018	0.008	10 units
	12		3NW6 006-1		018	0.008	10 units
	16		3NW6 005-1		018	0.008	10 units
	20		3NW6 007-1		018	0.008	10 units
	25		3NW6 010-1		018	0.008	10 units
	32		3NW6 012-1		018	0.008	10 units
	4	500	3NW6 104-1		018	0.019	10 units
	6		3NW6 101-1		018		
	8		3NW6 108-1		018	0.019	10 units
	10		3NW6 103-1		018	0.019	10 units
	12		3NW6 106-1		018	0.019	10 units
	16		3NW6 105-1		018	0.019	10 units
	20		3NW6 107-1		018	0.019	10 units
	25		3NW6 110-1		018	0.019	10 units
	32		3NW6 112-1		018	0.019	10 units
	40		3NW6 117-1		018	0.019	10 units
	50		3NW6 120-1		018	0.019	10 units
			8	500	3NW6 208-1		018
10		3NW6 203-1			018		
12		3NW6 206-1			018		
16		3NW6 205-1			018		
20		3NW6 207-1			018		
25		3NW6 210-1			018		
32		3NW6 212-1		018	0.051	10 units	
40		3NW6 217-1		018	0.051	10 units	
50		3NW6 220-1		018	0.051	10 units	
63		3NW6 222-1		018	0.051	10 units	
80		3NW6 224-1		018	0.051	10 units	
100		3NW6 230-1	400		018	0.051	10 units

Fuses and Fuse Systems

Cylindrical Fuse Systems

Bases for cylindrical fuses

Selection and ordering data

	I_n	For fuse link size	MW	Order No.	Price 1 unit	PG	Weight 1 unit approx.	PS*/P. unit
	A	mm x mm					kg	Unit(s)
Withdrawable-unit design								
Without signal detector								
	1-pole							
	 20	8 x 32	1	3NW7 313		018	0.056	1 unit
	 32	10 x 38	1	3NW7 013		018	0.056	1 unit
	 50	14 x 51	1.5	3NW7 111		018	0.095	1 unit
	100	22 x 58	2	3NW7 211		018	0.145	1 unit
	1-pole + N							
	 ... 20	8 x 32	1	3NW7 353		018	0.069	1 unit
	 ... 32	10 x 38	1	3NW7 053		018	0.069	1 unit
	 ... 50	14 x 51	3	3NW7 151		018	0.215	1 unit
	100	22 x 58	4	3NW7 251		018	0.330	1 unit
	2-pole							
	 20	8 x 32	2	3NW7 323		018	0.118	1 unit
	 32	10 x 38	2	3NW7 023		018	0.118	1 unit
	 50	14 x 51	3	3NW7 121		018	0.195	1 unit
	100	22 x 58	4	3NW7 221		018	0.300	1 unit
	3-pole							
	 20	8 x 32	3	3NW7 333		018	0.172	1 unit
	 32	10 x 38	3	3NW7 033		018	0.172	1 unit
	 50	14 x 51	4.5	3NW7 131		018	0.295	1 unit
	100	22 x 58	6	3NW7 231		018	0.691	1 unit
	3-pole + N							
	 20	8 x 32	3	3NW7 363		018	0.185	1 unit
	 32	10 x 38	3	3NW7 063		018	0.185	1 unit
	 50	14 x 51	6	3NW7 161		018	0.315	1 unit
	100	22 x 58	8	3NW7 261		018	0.475	1 unit
With signal detector								
	1-pole							
	 20	8 x 32	1	3NW7 312		018	0.058	1 unit
	 32	10 x 38	1	3NW7 012		018	0.080	1 unit
	 50	14 x 51	1.5	3NW7 112		018	0.095	1 unit
	100	22 x 58	2	3NW7 212		018	0.145	1 unit
	1-pole + N							
	 20	8 x 32	2	3NW7 352		018	0.120	1 unit
	 32	10 x 38	2	3NW7 052		018	0.167	1 unit
	 50	14 x 51	3	3NW7 152		018	0.215	1 unit
	100	22 x 58	4	3NW7 252		018	0.330	1 unit
	2-pole							
	 20	8 x 32	2	3NW7 322		018	0.112	1 unit
	 32	10 x 38	2	3NW7 022		018	0.162	1 unit
	 50	14 x 51	3	3NW7 122		018	0.195	1 unit
	100	22 x 58	4	3NW7 222		018	0.300	1 unit
	3-pole							
	 20	8 x 32	3	3NW7 332		018	0.167	1 unit
	 32	10 x 38	3	3NW7 032		018	0.243	1 unit
	 50	14 x 51	4.5	3NW7 132		018	0.295	1 unit
	100	22 x 58	6	3NW7 232		018	0.480	1 unit
	3-pole + N							
	 20	8 x 32	4	3NW7 362		018	0.227	1 unit
	 32	10 x 38	4	3NW7 062		018	0.327	1 unit
	 50	14 x 51	6	3NW7 162		018	0.315	1 unit
	100	22 x 58	8	3NW7 262		018	0.475	1 unit
Auxiliary switches								
	For indicating disconnection of the fuse link Solely for application of Striker fuse links (not currently available in the Siemens manufacturing program). For retrofitting with factory-fitted brackets, 0.5 MW. Contact: 250 V AC, 5 A Minimum contact load: 12 V, 25 mA							
	For fuse bases	14 x 51	0.5	3NW7 901		018	0.050	1 unit
	For fuse bases	22 x 58		3NW7 902		018	0.050	1 unit

* You can order this quantity or a multiple thereof.

Fuses and Fuse Systems

Cylindrical Fuse Systems

Bases for cylindrical fuses



Size	Length approx. mm	Conductor cross-section mm ²	Load rating up to A	Version	Order No.	Price 1 unit	PG	Weight 1 unit approx. kg	PS*/P. unit Unit(s)	
Busbars with pins, insulated										
The load capacity values are valid for centered infeed. Degree of pollution 2										
Busbars, 1-phase										
	8 x 32 and	220	16	120	Fully insulated	5ST3 700		027	0.040	1 unit
	10 x 38	1000	16	120		5ST3 701		027	0.190	1 unit
	14 x 51	1000	16	120		5SH5 324		016	0.320	1 unit
Busbars, 2-phase										
	8 x 32 and	220	16	120	Fully insulated	5ST3 704		027	0.060	1 unit
	10 x 38	1000	16	120		5ST3 705		027	0.290	1 unit
Busbars, 3-phase										
	8 x 32 and	220	16	120		5ST3 708		027	0.100	1 unit
	10 x 38	1000	16	120		5ST3 710		027	0.430	1 unit
	14 x 51	1000	16	120		5SH5 323		016	0.843	1 unit
End caps for busbars										
	1-phase					5ST3 748		027	0.001	1 unit
	2-phase and 3-phase					5ST3 750		027	0.001	1 unit

Fuses and Fuse Systems

SITOR 3NE, 3NC Semiconductor Fuses

SITOR LV HRC fuse links

Selection and ordering data

Size	I_n	Operational class	Order No.	Price 1 unit	PG	Weight 1 unit approx. kg	PS*/P. unit Unit(s)	
Rated voltage 500 V AC								
With bolt-on links								
Mounting dimensions: 110 mm								
	3 ¹⁾	150	gR	3NC2 423-3		047	1.063	3 units
		200	gR	3NC2 425-3		047	1.057	3 units
		250	gR	3NC2 427-3		047	1.066	3 units
		300	gR	3NC2 428-3		047	1.078	3 units
		350	aR	3NC2 431-3		047	1.056	3 units
		400	aR	3NC2 432-3		047	1.062	3 units
Special design with 2 oblong slots								
3	150	gR	3NC2 423		047	1.055	3 units	
	200	gR	3NC2 425		047	1.070	3 units	
	250	gR	3NC2 427		047	1.056	3 units	
	300	gR	3NC2 428		047	1.056	3 units	
	350	aR	3NC2 431		047	1.061	3 units	
	400	aR	3NC2 432		047	1.056	1 unit	
Rated voltage 690 V AC/700 V DC								
With bolt-on links								
Mounting dimensions: 80 mm								
	000	20	gR	3NE8 714-1		047	0.130	10 units
		25	gR	3NE8 715-1		047	0.130	10 units
		32	gR	3NE8 701-1		047	0.131	10 units
		40	gR	3NE8 702-1		047	0.131	10 units
		50	gR	3NE8 717-1		047	0.132	10 units
		63	aR	3NE8 718-1		047	0.132	10 units
		80	aR	3NE8 720-1		047	0.131	10 units
		100	aR	3NE8 721-1		047	0.130	10 units
		125	aR	3NE8 722-1		047	0.131	10 units
		160	aR	3NE8 724-1		047	0.132	10 units
		200	aR	3NE8 725-1		047	0.130	10 units
		250	aR	3NE8 727-1		047	0.133	10 units
		315	aR	3NE8 731-1		047	0.134	10 units
	Rated voltage 660 V AC							
With bolt-on links								
Mounting dimensions: 110 mm								
	3	150	gR	3NC8 423-3		047	1.062	3 units
		200	gR	3NC8 425-3		047	1.063	3 units
		250	gR	3NC8 427-3		047	1.069	3 units
		350	gR	3NC8 431-3		047	1.072	3 units
		500	gR	3NC8 434-3		047	1.069	3 units
		1000	aR	3NC8 444-3		047	1.085	3 units
Special design with 2 oblong slots								
3 ¹⁾	150	gR	3NC8 423		047	1.044	3 units	
	200	gR	3NC8 425		047	1.060	3 units	
	250	gR	3NC8 427		047	1.074	3 units	
	350	gR	3NC8 431		047	1.065	3 units	
	500	gR	3NC8 434		047	1.095	3 units	

1) Cladding dimensions and grip lugs according to IEC 60269-2-1; but blade slotted according to IEC 60269-4-1.

* You can order this quantity or a multiple thereof.







Siemens LV 1 · 2006

19/35

Fuses and Fuse Systems

SITOR 3NE, 3NC Semiconductor Fuses







SITOR LV HRC fuse links

Size	I_n	Operational class	Order No.	Price 1 unit	PG	Weight 1 unit approx.	PS*/P. unit		
	A					kg	Unit(s)		
Rated voltage 690 V AC									
For mounting in LV HRC fuse bases									
	000	16	gR/gS	3NE1 813-0		047	0.127	3 units	
		20	gR/gS	3NE1 814-0		047	0.128	3 units	
		25	gR/gS	3NE1 815-0		047	0.127	3 units	
		00	35	gR/gS	3NE1 803-0		047	0.128	3 units
			40	gR/gS	3NE1 802-0		047	0.127	3 units
			50	gR/gS	3NE1 817-0		047	0.128	3 units
			63	gR/gS	3NE1 818-0		047	0.128	3 units
			80	gR/gS	3NE1 820-0		047	0.129	3 units
	00	100	gR/gS	3NE1 021-0		047	0.202	3 units	
		125	gR/gS	3NE1 022-0		047	0.202	3 units	
	1	160	gR/gS	3NE1 224-0		047	0.580	3 units	
		200	gR/gS	3NE1 225-0		047	0.582	3 units	
		250	gR/gS	3NE1 227-0		047	0.580	3 units	
		315	gR/gS	3NE1 230-0		047	0.581	3 units	
	2	350	gR/gS	3NE1 331-0		047	0.766	3 units	
		400	gR/gS	3NE1 332-0		047	0.743	3 units	
		450	gR/gS	3NE1 333-0		047	0.760	3 units	
		500	gR/gS	3NE1 334-0		047	0.766	3 units	
	3	560	gR/gS	3NE1 435-0		047	1.111	3 units	
		630	gR/gS	3NE1 436-0		047	1.114	3 units	
		710	gR/gS	3NE1 437-0		047	1.117	3 units	
		800	gR/gS	3NE1 438-0		047	1.124	3 units	
Rated voltage 600 V AC									
For mounting in LV HRC fuse bases									
3	710	gR	3NE1 437-1		047	1.120	3 units		
	800	gR	3NE1 438-1		047	1.113	3 units		

Fuses and Fuse Systems

SITOR 3NE, 3NC Semiconductor Fuses

SITOR LV HRC fuse links

Size	I_n	Operational class	Order No.	Price 1 unit	PG	Weight 1 unit approx.	PS*/P. unit
	A					kg	Unit(s)
Rated voltage 690 V AC							
For mounting in LV HRC fuse bases							
	00	80	gR	3NE1 020-2		0.47	0.203 1 unit
		100	gR	3NE1 021-2		0.47	0.203 1 unit
		125	gR	3NE1 022-2		0.47	0.203 3 units
	1	160	gR	3NE1 224-2		0.47	0.613 3 units
		200	gR	3NE1 225-2		0.47	0.612 3 units
		250	gR	3NE1 227-2		0.47	0.626 3 units
		315	gR	3NE1 230-2		0.47	0.615 3 units
	2	350	gR	3NE1 331-2		0.47	0.754 3 units
		450	gR	3NE1 333-2		0.47	0.768 3 units
		500	gR	3NE1 334-2		0.47	0.768 3 units
	3	560	gR	3NE1 435-2		0.47	1.149 3 units
		630	gR	3NE1 436-2		0.47	1.179 3 units
		670	gR	3NE1 447-2		0.47	1.170 3 units
		710	gR	3NE1 437-2		0.47	1.153 3 units
		800	gR	3NE1 438-2		0.47	1.184 3 units
	850	gR	3NE1 448-2		0.47	1.207 3 units	
	00	25	gR	3NE8 015-1		0.47	0.205 3 units
		35	gR	3NE8 003-1		0.47	0.204 3 units
		50	gR	3NE8 017-1		0.47	0.203 3 units
		63	gR	3NE8 018-1		0.47	0.205 3 units
		80	aR	3NE8 020-1		0.47	0.203 3 units
		100	aR	3NE8 021-1		0.47	0.205 3 units
		125	aR	3NE8 022-1		0.47	0.213 3 units
	160	aR	3NE8 024-1		0.47	0.207 3 units	
Rated voltage 800 V AC							
With bolt-on links							
Mounting dimensions: 110 mm							
	2¹⁾	250	aR	3NE4 327-0B		0.47	0.753 3 units
		315	aR	3NE4 330-0B		0.47	0.760 3 units
		450	aR	3NE4 333-0B		0.47	0.760 3 units
		500	aR	3NE4 334-0B		0.47	0.754 3 units
		710	aR	3NE4 337		0.47	0.771 3 units

1) Cladding dimensions and grip lugs according to IEC 60269-2-1; but blade slotted according to IEC 60269-4-1.

* You can order this quantity or a multiple thereof.







Siemens LV 1 · 2006

19/37

Fuses and Fuse Systems

SITOR 3NE, 3NC Semiconductor Fuses

SITOR LV HRC fuse links



Size	I_n	Operational class	Order No.	Price 1 unit	PG	Weight 1 unit approx.	PS*/P. unit	
	A					kg	Unit(s)	
Rated voltage 1000 V AC								
For mounting in LV HRC fuse bases								
	0	32	gR	3NE4 101		0.278	3 units	
		40		3NE4 102		0.277	3 units	
		50		3NE4 117		0.276	3 units	
		63	aR	3NE4 118		0.279	3 units	
		80		3NE4 120		0.276	3 units	
		100		3NE4 121		0.278	3 units	
	125		3NE4 122		0.279	3 units		
	160		3NE4 124		0.279	3 units		
With bolt-on links								
Mounting dimensions: 110 mm								
	1¹⁾	100	aR	3NE3 221		0.580	3 units	
		125		3NE3 222		0.568	3 units	
		160		3NE3 224		0.573	3 units	
		200		3NE3 225		0.570	3 units	
		250		3NE3 227		0.580	3 units	
		315		3NE3 230-0B		0.585	3 units	
		350		3NE3 231		0.590	3 units	
		400		3NE3 232-0B		0.576	3 units	
		450		3NE3 233		0.720	3 units	
		400	aR	3NE3 332-0B		0.759	3 units	
	2¹⁾	450		3NE3 333		0.748	3 units	
		500		3NE3 334-0B		0.753	3 units	
		560		3NE3 335		0.756	3 units	
		630		3NE3 336		0.760	3 units	
		710 ²⁾		3NE3 337-8		0.762	3 units	
		800 ³⁾		3NE3 338-8		0.764	3 units	
		900 ⁴⁾		3NE3 340-8		0.753	3 units	
	Mounting dimensions: 130 mm							
		3	100	aR	3NE3 421		1.200	3 units
			224		3NE3 626		1.300	3 units
		315		3NE3 430		1.241	3 units	
		400		3NE3 432		1.247	3 units	
		450		3NE3 635		1.179	3 units	
		450 ⁵⁾		3NE3 635-6		1.184	3 units	
		500		3NE3 434		1.490	3 units	
		630		3NE3 636		1.213	3 units	
		710		3NE3 637		1.190	3 units	
Mounting dimensions: 140 mm, M12 screw connection								
3	710	aR	3NE3 637-1		1.246	3 units		
Rated voltage 1500 V AC								
With bolt-on links								
Mounting dimensions: 210 mm								
	3	160	aR	3NE5 424		1.900	2 units	
		224		3NE5 426		1.968	2 units	
		315		3NE5 430		2.000	2 units	
		350		3NE5 431		1.959	2 units	
		450		3NE5 433		2.100	2 units	
		450 ⁶⁾		3NE5 433-1		1.961	2 units	
		250		3NE5 627		1.562	3 units	
		450		3NE5 633		1.585	3 units	
		600		3NE5 643		1.587	3 units	
								

- Cladding dimensions and grip lugs according to IEC 60269-2-1; but blade slotted according to IEC 60269-4-1.
- Rated voltage 900 V AC.
- Rated voltage 800 V AC.
- Rated voltage 690 V AC.
- Design corresponds to 3NE6 4.. and 3NE9 4..
- M12 screw connection.

Fuses and Fuse Systems

SITOR 3NE, 3NC Semiconductor Fuses

SITOR LV HRC fuse links

Size	I_n	Operational class	Order No.	Price 1 unit	PG	Weight 1 unit approx. kg	PS*/P. unit Unit(s)
Rated voltage 2000 V AC							
With bolt-on links							
Mounting dimensions: 210 mm							
	3	200	aR	3NE7 425	047	2.100	2 units
		250		3NE7 427	047	1.970	2 units
		350		3NE7 431	047	1.980	2 units
		400		3NE7 432	047	1.973	2 units
		450		3NE7 633	047	1.968	2 units
		450 ¹⁾		3NE7 633-1	047	1.983	2 units
		525 ¹⁾		3NE7 648-1	047	1.975	2 units
		630		3NE7 636	047	1.997	2 units
		630 ¹⁾		3NE7 636-1	047	2.024	2 units
		710 ¹⁾		3NE7 637-1	047	1.997	2 units
Rated voltage 2500 V AC							
With bolt-on links							
Mounting dimensions: 260 mm							
	3	400 ¹⁾	aR	3NE9 632-1	047	2.542	1 unit
		500 ¹⁾		3NE9 634-1	047	2.550	1 unit
		630 ¹⁾		3NE9 636-1A	047	2.557	1 unit

1) M12 screw connection.

* You can order this quantity or a multiple thereof.

Siemens LV 1 · 2006

19/39

Fuses and Fuse Systems

SITOR 3NE, 3NC Semiconductor Fuses

SITOR cylindrical fuse links

Selection and ordering data



	Size	I_n	U_n	Operational class	Order No.	Price 1 unit	PG	Weight 1 unit approx.	PS*/P. unit
	mm x mm	A	V AC/ DC					kg	Unit(s)
Cylindrical fuse links									
	10 x 38	3	600/-	aR	3NC1 003		047	0.009	10 units
		6			3NC1 006			0.009	10 units
		8			3NC1 008			0.009	10 units
		10			3NC1 010			0.009	10 units
		12			3NC1 012			0.009	10 units
		16			3NC1 016			0.009	10 units
		20			3NC1 020			0.009	10 units
		25			3NC1 025			0.009	10 units
		32			3NC1 032			0.009	10 units
	14 x 51	1	660/700	aR	3NC1 401		047	0.020	10 units
		2			3NC1 402			0.020	10 units
		3			3NC1 403			0.020	10 units
		4			3NC1 404			0.020	10 units
		5	690/700		3NC1 405		047	0.020	10 units
		6			3NC1 406			0.020	10 units
10		3NC1 410	0.020	10 units					
15		3NC1 415	0.020	10 units					
20		3NC1 420	0.020	10 units					
25		3NC1 425	0.020	10 units					
30		3NC1 430	0.020	10 units					
32		3NC1 432	0.021	10 units					
40		3NC1 440	0.021	10 units					
50		3NC1 450	0.021	10 units					
22 x 58		20	690/700	aR	3NC2 220		047	0.056	5 units
	25	3NC2 225			0.056			5 units	
	32	3NC2 232			0.056			5 units	
	40	3NC2 240	0.056	5 units					
	50	3NC2 250	0.056	5 units					
	63	3NC2 263	0.056	5 units					
	80	3NC2 280	0.057	5 units					
	100	3NC2 200	0.057	5 units					
	Cylindrical fuse links with hammer								
14 x 51	10	690/700	aR	3NC1 410-5		047	0.020	10 units	
	15			3NC1 415-5			0.020	10 units	
	20			3NC1 420-5			0.020	10 units	
	25	3NC1 425-5	0.020	10 units					
	30	3NC1 430-5	0.020	10 units					
	32	3NC1 432-5	0.020	10 units					
	40	3NC1 440-5	0.020	10 units					
	50	3NC1 450-5	0.020	10 units					
	22 x 58	20	690/700	aR	3NC2 220-5		047	0.056	10 units
25		3NC2 225-5			0.056			10 units	
32		3NC2 232-5			0.056			10 units	
40		3NC2 240-5	0.056	10 units					
50		3NC2 250-5	0.056	10 units					
63		3NC2 263-5	0.056	10 units					
80		3NC2 280-5	0.057	10 units					
100		3NC2 200-5	0.057	10 units					

Fuses and Fuse Systems



SITOR 3NE, 3NC Semiconductor Fuses

SITOR cylindrical fuse links

Accessories

	Size	Version	Order No.	Price 1 unit	PG	Weight 1 unit approx. kg	PS*/ P. unit Unit(s)	
Fuse tongs								
	10 x 38, 14 x 51, 22 x 58		3NC1 000		047	0.069	1 unit	
Cylindrical fuse switch disconnectors								
	10 x 38	1-pole 2-pole 3-pole	3NC1 091 3NC1 092 3NC1 093		047 047 047	0.065 0.131 0.197	12 units 6 units 4 units	
	14 x 51	1-pole 2-pole 3-pole	3NC1 491 3NC1 492 3NC1 493		047 047 047	0.125 0.233 0.350	6 units 3 units 2 units	
	Cylindrical fuse disconnectors							
	22 x 58	1-pole 2-pole 3-pole	3NC2 291 3NC2 292 3NC2 293		047 047 047	0.193 0.381 0.584	6 units 3 units 2 units	
	Cylindrical fuse switch disconnectors with alarm switch							
	For fuse links with hammer	14 x 51	1-pole	3NC1 491-5		047	0.125	6 units
Cylindrical fuse disconnectors with alarm switch								
For fuse links with hammer	22 x 58	1-pole	3NC2 291-5		047	0.193	6 units	
Cylindrical fuse bases								
	10 x 38	1-pole 2-pole 3-pole	3NC1 038-1 3NC1 038-2 3NC1 038-3		047 047 047	0.042 0.077 0.113	10 units 8 units 6 units	
	14 x 51	1-pole ¹⁾	3NC1 451-1		047	0.120	3 units	
	22 x 58	1-pole ¹⁾	3NC2 258-1		047	0.238	3 units	
	Cylindrical fuse clips							
	For fuses 10 x 38 For fuses 14 x 51			3NC1 038 3NC1 451		047 047	0.002 0.005	20 units 20 units

1) The cylindrical fuse bases can be modularly expanded to make multi-pole bases.

	Size	Length approx. mm	Conductor cross-section mm ²	Load rating up to A	Version	Order No.	Price 1 unit	PG	Weight 1 unit approx. kg	PS*/ P. unit Unit(s)
Busbars										
The load capacity values are valid for centered infeed. Pins, insulated Degree of pollution 2										
Busbars, 1-phase										
	8 x 32 and	220	16	120	Fully insulated	5ST3 700		027	0.040	1 unit
	10 x 38	1000	16	120		5ST3 701		027	0.190	1 unit
	14 x 51	1000	16	120		5SH5 324		016	0.320	1 unit
Busbars, 2-phase										
	8 x 32 and	220	16	120	Fully insulated	5ST3 704		027	0.060	1 unit
	10 x 38	1000	16	120		5ST3 705		027	0.290	1 unit
Busbars, 3-phase										
	8 x 32 and	220	16	120		5ST3 708		027	0.100	1 unit
	10 x 38	1000	16	120		5ST3 710		027	0.430	1 unit
	14 x 51	1000	16	120		5SH5 323		016	0.843	1 unit
End caps for busbars										
	1-phase					5ST3 748		027	0.001	1 unit
	2-phase and 3-phase					5ST3 750		027	0.001	1 unit

* You can order this quantity or a multiple thereof.

Siemens LV 1 · 2006







19/41

Fuses and Fuse Systems

SITOR Fuse Links for Special Applications

For rectifiers in electrolysis systems,
SITOR thyristor sets, railway supply rectifiers

Selection and ordering data

I_n	U_n	Operational class	Order No.	Price 1 unit	PG	Weight 1 unit approx.	PS*/P. unit
A	V AC					kg	Unit(s)
For rectifiers in electrolysis systems							
For screwing onto water-cooled busbars							
	350	800	aR	3NC5 531		0.671	1 unit
	600	1000		3NC5 840	047	1.408	3 units
	630	800		3NC5 841	047	1.185	3 units
	800	1000		3NC5 838	047	1.196	3 units
	710	900		3NE6 437-7	047	1.168	3 units
	1250	600		3NE9 450-7	047	1.245	3 units
For air-cooled rectifiers in electrolysis systems							
	710	800	gR	3NE6 437	047	1.093	3 units
	850	1000		3NE9 440-6	047	1.082	3 units
	900	1000	aR	3NE6 444	047	1.175	3 units
	1250	800		3NE9 450	047	1.114	3 units
For SITOR 6QG10 thyristor sets							
	200	1000	aR	3NE3 525-5	047	0.744	3 units
	450			3NE3 535-5	047	0.746	3 units
For SITOR 6QG11 thyristor sets							
	50	1000	gR	3NE4 117-5	047	0.303	1 unit
	100		aR	3NE4 121-5	047	0.309	1 unit
	170	800		3NE4 146-5	047	0.311	1 unit
For SITOR 6QG12 thyristor sets							
	250	800	aR	3NE4 327-6B	047	0.692	3 units
	315			3NE4 330-6B	047	0.688	3 units
	450			3NE4 333-6B	047	0.690	3 units
	500			3NE4 334-6B	047	0.688	3 units
	710			3NE4 337-6	047	0.689	3 units
For railway supply rectifiers							
	250	680	aR	3NC7 327-2	047	0.725	3 units
	350			3NC7 331-2	047	0.740	3 units

Fuses and Fuse Systems

SILIZED 5SD, 5SE Semiconductor Fuses

Fuse links

Overview

SILIZED NEOZED fuse links



- Rated voltage U_n 400 V AC, 250 V DC
- Rated current I_n 10 ... 63 A
- Sizes D01 and D02
- Operational class gR

SILIZED DIAZED fuse links



- Rated voltage U_n 500 V AC, 500 V DC
- Rated current I_n 16 ... 100 A
- Operational class gR
- Characteristic super quick

Selection and ordering data

Size	I_n	Order No.	Price 1 unit	PG	Weight 1 unit approx. kg	PS*/P. unit Unit(s)
------	-------	-----------	--------------	----	--------------------------	---------------------

Rated voltage 400 V AC/250 V DC, operational class gR

Consumer packing, package of 10

	D01	10	5SE1 310	016	0.006	10 units
		16	5SE1 316	016	0.007	10 units
	D02	20	5SE1 320	016	0.012	10 units
		25	5SE1 325	016	0.012	10 units
		35	5SE1 335	016	0.012	10 units
		50	5SE1 350	016	0.013	10 units
		63	5SE1 363	016	0.014	10 units

Size	I_n	Identification color	Thread	Order No.	Price 1 unit	PG	Weight 1 unit approx. kg	PS*/P. unit Unit(s)
------	-------	----------------------	--------	-----------	--------------	----	--------------------------	---------------------

Rated voltage 500 V AC/500 V DC

DIN VDE 0636-301

For semiconductor protection, designation, yellow ring operational class gR, characteristic super quick.
For 30 A fuse links the DIAZED screw adapter DII for 25 A is used

	DII	16	Gray	E27	5SD4 20	016	0.028	5 units
		20	Blue		5SD4 30	016	0.029	5 units
		25	Yellow		5SD4 40	016	0.031	5 units
		30			5SD4 80	016	0.031	5 units
DIII	35	Black	E33	5SD4 50	016	0.050	5 units	
		White		5SD4 60	016	0.051	5 units	
		Copper		5SD4 70	016	0.054	5 units	
DIV	80	Silver	R1¼"	5SD5 10	016	0.110	3 units	
		Red		5SD5 20	016	0.110	3 units	

* You can order this quantity or a multiple thereof.

Siemens LV 1 · 2006





19/43

Fuses and Fuse Systems

3ND, 3NW Fuse Links for Motor Circuits

LV HRC fuse links aM

Selection and ordering data



Size	Width	I_n	U_n	Non-insulated grip lugs		PG	Weight 1 unit approx.	PS*/ P. unit
				Order No.	Price 1 unit			
	mm	A	V				kg	Unit(s)
LV HRC fuse links with front indicator, operational class aM								
	000	21	500 V AC	6	3ND1 801	014	0.130	3 units
				10	3ND1 803	014	0.130	3 units
				16	3ND1 805	014	0.130	3 units
				20	3ND1 807	014	0.130	3 units
				25	3ND1 810	014	0.130	3 units
				32	3ND1 812	014	0.130	3 units
				35	3ND1 814	014	0.130	3 units
				40	3ND1 817	014	0.130	3 units
				50	3ND1 820	014	0.130	3 units
				63	3ND1 822	014	0.130	3 units
80	3ND1 824	014	0.130	3 units				
	00	30	500 V AC	100	3ND1 830	014	0.192	3 units
				125	3ND1 832	014	0.192	3 units
				160	3ND1 836	014	0.192	3 units
	1	30	690 V AC	63	3ND2 122	014	0.290	3 units
				80	3ND2 124	014	0.290	3 units
				100	3ND2 130	014	0.440	3 units
				125	3ND2 132	014	0.440	3 units
		47.2		160	3ND2 136	014	0.440	3 units
				200	3ND2 140	014	0.440	3 units
				250	3ND2 144	014	0.440	3 units
	2	47.2	690 V AC	125	3ND2 232	014	0.440	3 units
				160	3ND2 236	014	0.440	3 units
				200	3ND2 240	014	0.440	3 units
		57.8		250	3ND2 244	014	0.440	3 units
				315	3ND2 252	014	0.650	3 units
				355	3ND2 254	014	0.650	3 units
				400	3ND2 260	014	0.650	3 units
	3	57.8	690 V AC	315	3ND2 352	014	0.650	3 units
				355	3ND2 354	014	0.650	3 units
				400	3ND2 360	014	0.650	3 units
		71.2		500	3ND1 365	014	1.030	3 units
				630	3ND1 372	014	1.000	3 units

Fuses and Fuse Systems

3ND, 3NW Fuse Links for Motor Circuits

Cylindrical fuse links aM

Selection and ordering data

Size	I_n	U_n	Operational class aM		PG	Weight 1 unit approx.	PS*/ P. unit		
			Order No.	Price 1 unit					
mm × mm	A	V AC				kg	Unit(s)		
Cylindrical fuse links									
	10 × 38	0.5	500	3NW8 000-1		018	0.003	10 units	
				3NW8 011-1		018	0.008	10 units	
				3NW8 002-1		018	0.008	10 units	
				3NW8 004-1		018	0.008	10 units	
				3NW8 001-1		018	0.008	10 units	
				3NW8 008-1		018	0.003	10 units	
				3NW8 003-1		018	0.008	10 units	
				3NW8 006-1		018	0.008	10 units	
				3NW8 005-1		018	0.008	10 units	
				3NW8 007-1		018	0.008	10 units	
			25	400	3NW8 010-1		018	0.008	10 units
	14 × 51	2	500	3NW8 102-1		018	0.019	10 units	
				3NW8 104-1		018	0.019	10 units	
				3NW8 101-1		018	0.019	10 units	
				3NW8 108-1		018	0.019	10 units	
				3NW8 103-1		018	0.019	10 units	
				3NW8 106-1		018	0.019	10 units	
				3NW8 105-1		018	0.019	10 units	
				3NW8 107-1		018	0.019	10 units	
				3NW8 110-1		018	0.019	10 units	
				3NW8 112-1		018	0.019	10 units	
			40	400	3NW8 117-1		018	0.019	10 units
			50	400	3NW8 120-1		018	0.019	10 units
	22 × 58	10	500	3NW8 203-1		018	0.051	10 units	
				3NW8 206-1		018	0.051	10 units	
				3NW8 205-1		018	0.051	10 units	
				3NW8 207-1		018	0.051	10 units	
				3NW8 210-1		018	0.051	10 units	
				3NW8 212-1		018	0.051	10 units	
				3NW8 217-1		018	0.051	10 units	
				3NW8 220-1		018	0.051	10 units	
				3NW8 222-1		018	0.051	10 units	
				3NW8 224-1		018	0.051	10 units	
			100	400	3NW8 230-1		018	0.051	10 units

* You can order this quantity or a multiple thereof.

Fuses and Fuse Systems

American/Canadian Fuses Class CC

Class CC fuse links and holders

Selection and ordering data

Rated current	Characteristic slow		Characteristic quick		Characteristic slow, current limiting		PG	Weight 1 unit approx.	PS*/P. unit
	Order No.	Price 1 unit	Order No.	Price 1 unit	Order No.	Price 1 unit			
A								kg	Unit(s)
Class CC fuses									
0.6 (6/10)	3NW1 006-0HG		--		--		018	0.008	10 units
0.8 (8/10)	3NW1 0080HG		--		--		018	0.008	10 units
1	3NW1 010-0HG		3NW2 010-0HG		3NW3 010-0HG		018	0.008	10 units
1.5 (1 ½)	3NW1 015-0HG		--		--		018	0.008	10 units
2	3NW1 020-0HG		3NW2 020-0HG		3NW3 020-0HG		018	0.008	10 units
3	3NW1 030-0HG		3NW2 030-0HG		3NW3 030-0HG		018	0.008	10 units
4	3NW1 040-0HG		3NW2 040-0HG		3NW3 040-0HG		018	0.008	10 units
5	3NW1 050-0HG		3NW2 050-0HG		3NW3 050-0HG		018	0.008	10 units
6	3NW1 060-0HG		3NW2 060-0HG		3NW3 060-0HG		018	0.008	10 units
8	3NW1 080-0HG		3NW2 080-0HG		3NW3 080-0HG		018	0.008	10 units
10	3NW1 100-0HG		3NW2 100-0HG		3NW3 100-0HG		018	0.008	10 units
12	3NW1 120-0HG		3NW2 120-0HG		3NW3 120-0HG		018	0.008	10 units
15	3NW1 150-0HG		3NW2 150-0HG		3NW3 150-0HG		018	0.008	10 units
20	3NW1 200-0HG		3NW2 200-0HG		3NW3 200-0HG		018	0.008	10 units
25	3NW1 250-0HG		3NW2 250-0HG		3NW3 250-0HG		018	0.008	10 units
30	3NW1 300-0HG		3NW2 300-0HG		3NW3 300-0HG		018	0.008	10 units





Version	Rated voltage	Rated current	MW	Order No.	Price	PG	Weight 1 unit approx.	PS*/P. unit
Class CC fuse holders								
1-pole	600	30	1	3NW7 513-0HG		018	0.056	1 unit
1-pole + N	600	30	1	3NW7 553-0HG		018	0.069	1 unit
2-pole	600	30	2	3NW7 523-0HG		018	0.118	1 unit
3-pole	600	30	3	3NW7 533-0HG		018	0.172	1 unit
3-pole + N	600	30	3	3NW7 563-0HG		018	0.185	1 unit
4-pole	600	30	4	3NW7 543-0HG		018	0.236	1 unit











SR60 Busbar System

Busbar systems

Selection and ordering data

	Dimensions W × H × D mm × mm × mm	Order No.	Price 1 unit	PG	Weight 1 unit approx. kg	PS*/ P. unit Unit(s)
 <p>Busbar holders for SR60 busbar system For busbars with a bar thickness of 5 or 10 mm and a busbar height of 12, 15, 20, 25 or 30 mm 60 mm busbar distance</p>	External 3-phase	20 × 220 × 50/55	8US19 23-2AA00	103	0.214	10 units
	Internal 3-phase	20 × 185 × 50/55	8US19 23-3AA00	103	0.200	10 units
	Internal 4-phase	20 × 245 × 50/55	8US19 23-4AA00	103	0.269	10 units
 <p>N/PE busbar holders For mounting onto busbar supports, can also be used as single holder</p>	1-phase	20 × 90 × 50/55	5SH3 506	016	0.070	4 units
 <p>SR60 connecting terminal plates 3-phase, for conductors from 150 to 300 mm² (illustration without cover)</p>			5SH3 535	016	1.657	1 unit
 <p>Connector blocks for SR60 busbars 3-phase, for conductors from 35 to 120 mm²</p>			8US19 21-1AA00	103	0.607	1 unit

Accessories

	Conductor cross-section Up to mm ²	Tightening torque Nm	Order No.	Price 1 unit	PG	Weight 1 unit approx. kg	PS*/ P. unit Unit(s)			
Connection terminals										
Terminals for one busbar 12 mm × 5 mm										
  8JH4 102 8JH4 104	1.5 ... 16	1.4	8JH4 102 8JH4 104		046	0.010	1 unit			
	16 ... 35	3.0						046	0.030	1 unit
  8JH4 105 8JK3 061	16 ... 70	6.0	8JH4 105 8JH4 106 8JK3 061		046	0.030	1 unit			
	16 ... 95	10.0						046	0.070	1 unit
	25 ... 120	10.0						046	0.090	1 unit
Terminals for two busbars 12 mm × 10 mm										
  8JH4 105 8JK3 061	16 ... 35	6.0	8JH4 105 8JH4 106 8JK3 061		046	0.030	1 unit			
	16 ... 70	10.0						046	0.070	1 unit
	25 ... 50	10.0						046	0.090	1 unit
Extension terminals For 12 mm × 5 mm busbar Busbar not included in delivery (1 set = 2 units)										
		6.0	8JK3 201		046	1 set 0.100	1 set			
Terminals for circular conductors 20 mm × 5 mm to 30 mm × 10 mm										
	150 ... 240		8US19 41-2BB00		103	0.307	6 units			

* You can order this quantity or a multiple thereof.













Siemens LV 1 · 2006

19/47

SR60 Busbar System





Mounting components

Selection and ordering data

Size	Rated current A	Rated voltage V	Order No.	Price 1 unit	PG	Weight 1 unit approx. kg	PS*/ P. unit Unit(s)
NEOZED SR60 bus-mounting bases							
For busbar thickness 5 mm							
NEOZED adapter sleeves							
3-pole							
	D02	63	400	5SG6 202		016	0.141 4 units
Excess width with clearance for wiring							
	D02	63	400	5SG6 204		016	0.154 4 units
For busbar thickness 10 mm							
NEOZED adapter sleeves							
3-pole							
	D02	63	400	5SG6 203		016	0.138 4 units
Excess width with clearance for wiring							
	D02	63	400	5SG6 205		016	0.149 4 units
DIAZED SR60 bus-mounting bases							
For busbar thickness 5 mm							
For use of DIAZED SR60 adapter rings							
3-pole							
	DII	25	500	5SF6 014		016	0.230 2 units
	DIII	63	690	5SF6 214		016	0.318 2 units
For use of DIAZED screw adapters							
3-pole							
	DII	25	500	5SF6 015		016	0.222 2 units
	DIII	63	690	5SF6 215		016	0.310 2 units
For busbar thickness 10 mm							
For use of DIAZED SR60 adapter rings							
3-pole							
	DII	25	500	5SF6 016		016	0.233 2 units
	DIII	63	690	5SF6 216		016	0.316 2 units
For use of DIAZED screw adapters							
3-pole							
	DII	25	500	5SF6 017		016	0.220 2 units
	DIII	63	690	5SF6 217		016	0.328 2 units

SR60 Busbar System

Mounting components

Size	MW	Order No.	Price 1 unit	PG	Weight 1 unit approx. kg	PS*/P. unit Unit(s)	
NEOZED SR60 covers							
	D02	1.5	5SH5 241	016	0.026	4 units	
	Excess width with clearance for wiring						
	D02	2	5SH5 242	016	0.031	4 units	
	With double width for more free space for wiring						
	D02	3	5SH5 243	016	0.040	4 units	
DIAZED SR60 covers							
	DII	2.3	5SH2 042	016	0.050	2 units	
	DIII	3.2	5SH2 242	016	0.061	2 units	
	With double width for more free space for wiring						
	DII	4.7	5SH2 043	016	0.084	2 units	
	DIII	6.4	5SH2 243	016	0.106	2 units	
Size	Thread	For fuse links	Order No.	Price 1 unit	PG	Weight 1 unit approx. kg	PS*/P. unit Unit(s)
							A
DIAZED SR60 adapter rings							
Only for DIAZED SR60 bus-mounting bases							
	DII	E 27	2	5SH3 071	016	0.005	10 units
			4	5SH3 072	016	0.005	10 units
			6	5SH3 073	016	0.005	10 units
			10	5SH3 074	016	0.005	10 units
			16	5SH3 075	016	0.005	10 units
			20	5SH3 076	016	0.004	10 units
	DIII	E 33	2	5SH3 078	016	0.008	10 units
			4	5SH3 080	016	0.008	10 units
			6	5SH3 081	016	0.008	10 units
			10	5SH3 082	016	0.008	10 units
		16	5SH3 083	016	0.008	10 units	
		20	5SH3 084	016	0.006	10 units	
		25	5SH3 085	016	0.007	10 units	
		35	5SH3 086	016	0.006	10 units	
		50	5SH3 087	016	0.005	10 units	

For NEOZED screw caps, adapter sleeves and fuse links, see Fuses and Fuse Systems --> NEOZED Fuse System. For DIAZED screw caps, adapter sleeves and fuse links, see Fuses and Fuse Systems --> DIAZED Fuse System.







* You can order this quantity or a multiple thereof.

Siemens LV 1 · 2006

19/49

SR60 Busbar System

Mounting components









	Rated current AC	Rated voltage AC	Order No.	Price 1 unit	PG	Weight 1 unit approx. kg	PS*/ P. unit Unit(s)		
	A	V							
 <p>NEOZED SR60 bus-mounting switch disconnectors For busbar thickness 5 and 10 mm For 3-phase busbar system Width: 1.5 MW 3-pole Size D02 2 4 6 1 3 5</p>	63	400	5SG7 230		016	0.700	1 unit		
 <p>SR60 bus-mounting disconnectors for 10 x 38 mm cylindrical fuses For busbar thickness 5 and 10 mm For 3-phase busbar system 3-pole 2 4 6 1 3 5</p>	32	690	3NW7 430		018	0.700	1 unit		
 <p>Auxiliary switches 1 changeover contact, 24 to 230 V AC, AC 2 A</p>			5SH5 525		016	0.007	1 unit		
 <p>Lateral modules For NEOZED SR60 bus-mounting switch disconnectors For better heat conduction at permanent loads over 35 A Width: 0.5 MW</p>			5SH5 526		016	0.060	1 unit		
 <p>Reducers For NEOZED fuse links D01 In the SR60 bus-mounting switch disconnectors</p>			5SH5 527		016	0.003	10 units		
			Order No.	Price 1 unit	PG	Weight 1 unit approx. kg	PS*/ P. unit Unit(s)		
 <p>SR60 LV HRC bus-mounting fuse bases Size 000 and 00 With cover, top terminals, for 5 and 10 mm busbar thickness 3-pole Terminals up to 70 mm² Rated voltage 690 V AC With saddle-type connector With flat connector, screw M8</p>			3NH4 052		014	0.641	1 unit		
			3NH4 053		014	0.646	1 unit		
			Order No.	Price 1 unit	PG	Weight 1 unit approx. kg	PS*/ P. unit Unit(s)		
 <p>Fuse switch disconnectors for SR60 busbars Climate-proof, rated operational voltage 690 V AC Delivered without LV HRC fuse links</p>	I_u	For LV HRC links	Conductor cross-section	Type of connection/ Adapter	Order No.	Price 1 unit	PG	Weight 1 unit approx. kg	PS*/ P. unit Unit(s)
	A	Size	Up to mm ²						
	100	000 and 00	1.5 ... 35	Top Bottom	3NP40 16-1CK01		103	0.916	1 unit
					3NP40 16-1CJ01		103	0.950	1 unit
	160	000 and 00	Up to 2 x 70	Top Bottom	3NP40 76-1CE01		103	1.203	1 unit
					3NP40 76-1CF01		103	1.201	1 unit
	160	000 and 00	2.5 ... 70 (SIGUT terminal)	Top Bottom	3NP40 76-1CK01		103	1.295	1 unit
					3NP40 76-1CJ01		103	1.249	1 unit
	250	0 and 1	max. 150	Top or bottom	3NP42 76-1CG01		103	3.713	1 unit
	400	2	max. 240	Top or bottom	3NP43 76-1CG01		103	5.440	1 unit
	630	3	max. 2 x 240	Top or bottom	3NP44 76-1CG01		103	7.688	1 unit

For more busbar adapters, see SIVACON Switchgear, Distribution Systems and Cabinets.
For more fuse switch disconnectors, see Switching and Protection Devices, Switch Disconnectors.

SR60 Busbar System

Accessories

Selection and ordering data

	Length	Order No.	Price 1 unit	PG	Weight 1 unit approx. kg	PS*/ P. unit Unit(s)
SR60 covers						
	Bases Height 230 mm, for 3 busbars 290 mm, for 4 busbars	1100	5SH3 526 5SH3 527	016	1.100	2 units
				016	1.300	2 units
	Blanking covers Depth 32 mm	1000	5SH3 537	016	0.075	2 units
	Cover profiles for busbars Up to 30 x 5 mm Up to 30 x 10 mm	1000	8US19 22-2AA00 8US19 22-2BA00	103	0.156	10 units
				103	0.105	10 units
	Edges H x W 17 x 36 mm, for 3 busbars 77 x 36 mm, for 4 busbars	1100	5SH3 528 5SH3 530	016	0.311	2 units
				016	0.583	2 units
	Partitions Slotted H x W 17 x 86 mm	1100	5SH3 531	016	0.365	2 units
SR60 covers						
	End covers for busbar supports, lateral Height 230 mm 290 mm (1 set = 2 right and 2 left end covers)		5SH3 533 5SH3 534	016	0.038	4 units
				016	0.048	4 units
	End covers for busbar supports, top 3-pole 4-pole		8US19 22-1AC00 8US19 22-1AB00	103	0.020	10 units
				103	0.055	1 unit
	Edge supports and supports for partitions		5SH3 532	016	0.106	2 units
	Supports for the blanking covers For blanking cover		5SH3 536	016	0.040	4 units

* You can order this quantity or a multiple thereof.

Siemens LV 1 · 2006

19/51

Miniature Circuit-Breakers

Introduction

Overview



Version	Tripping characteristic	Mounting depth [mm]	Rated currents I_n	Standards	Rated short-circuit capacity Energy limitation class	Usage		
						Non-residential buildings	Residential buildings	Industry
Standard product range								
5SJ6	B	70	6 ... 32 A	EN 60898	6 000 3	•	•	•
5SY6	B		6 ... 63 A			•	•	•
	C		0.3 ... 63 A			•	•	•
	D		0.3 ... 63 A			•	•	•
High-capacity product range								
5SJ4	B	70	6 ... 63 A	UL 489 CSA 22.2 No. 5.1	15 kA	•	•	•
	C		0.3 ... 63 A			•	•	•
	D		0.3 ... 63 A			•	•	•
5SY4	A		1 ... 63 A	EN 60898	10 000 3	•		•
	B		6 ... 80 A			•		•
	C		0.3 ... 80 A			•		•
	D		0.3 ... 63 A			•		•
5SY7	B		6 ... 63 A		15 000 3	•		•
	C		0.3 ... 63 A			•		•
	D		0.3 ... 63 A			•		•
5SY8	C		0.3 ... 63 A	EN 60947-2	25 kA	•		•
	D		0.3 ... 63 A			•		•
AC/DC product range								
5SY5	B	70	6 ... 63 A	EN 60898	10 000 3			•
	C		0.3 ... 63 A					•
High-current product range								
5SP4	B	70	80 ... 125 A	EN 60898	10 000	•		•
	C		80 ... 125 A			•		•
	D		80 ... 100 A			•		•
Power supply company product range								
5SP3	E	92	16 ... 100 A	DIN VDE 0645	25 000	•	•	
Approvals								
Standard product range								
5SJ6	•							
5SY6	•	•	•		•	•	•	•
High-capacity product range								
5SJ4				•				
5SY4	•	•	•		•	•	•	•
5SY7	•	•	•		•	•	•	•
5SY8			•					
AC/DC product range								
5SY5	•							
High-current product range								
5SP4	•		•			•		•
Power supply company product range								
5SP3	•							

Application

5SY6 ...-KV miniature circuit-breakers

- U_n : 230 V AC, 50 to 60 Hz
- Standards: EN 60898, DIN VDE 0641 Part 11, IEC 60898
- 1+N in 1 MW for distribution boards with little available space.
- Additional components can be retrofitted.

Selection and ordering data

	I_n A	MW	Characteristic B		PG	Characteristic C		PG	Weight 1 unit approx. kg	PS*/ P. unit Unit(s)
			Order No.	Price 1 unit		Order No.	Price 1 unit			
 <p>1-pole + N</p> 	2	1	--			5SY6 002-7KV		003	0.132	1 unit
	4		--			5SY6 004-7KV		003	0.132	1 unit
	6		5SY6 006-6KV		002	5SY6 006-7KV		003	0.132	1 unit
	8		--			5SY6 008-7KV		003	0.132	1 unit
	10		5SY6 010-6KV		002	5SY6 010-7KV		003	0.132	1 unit
	13		5SY6 013-6KV		002	5SY6 013-7KV		003	0.132	1 unit
	16		5SY6 016-6KV		002	5SY6 016-7KV		003	0.132	1 unit
	20		5SY6 020-6KV		002	5SY6 020-7KV		003	0.132	1 unit
	25		5SY6 025-6KV		002	5SY6 025-7KV		003	0.132	1 unit
	32		5SY6 032-6KV		002	5SY6 032-7KV		003	0.132	1 unit
	40		5SY6 040-6KV		002	5SY6 040-7KV		003	0.132	1 unit

* You can order this quantity or a multiple thereof.

Miniature Circuit-Breakers Standard Product Range

Auxiliary switches/fault signal contacts for 5SY6 ...-KV

Benefits

- An auxiliary switch or fault signal contact can be retrofitted to the left-hand side of the miniature circuit-breaker housing
- Mounting with factory-fitted screws
- Can be connected to *instabus* KNX EIB and AS-Interface bus or PROFIBUS through binary inputs

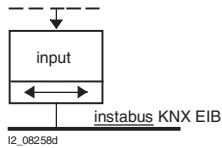
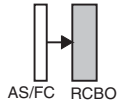

Application

- Auxiliary switch: Indications of the circuit state of the miniature circuit-breaker: ON/OFF
- Fault signal contact: Signaling of electrical triggering, no signaling of mechanical shut-down
- Short-circuit protection ensured by miniature circuit-breakers with characteristic B or C with $I_n = 4$ A or fuse gL 4 A
- Product standards: IEC/EN 62019 (VDE 0640)

Technical specifications

			5ST3 018-0KV, 5ST3 028-0KV
Terminals			
• Conductor cross-section	mm ²	0.5 ... 2.5	
• Recommended tightening torque	Nm	0.6 ... 0.8	
Min. contact load		50 mA/24 V	
Max. contact load			
• 230 V AC, AC-15	A	2	
• 230 V AC, AC-13	A	3	
• 110 V DC, DC-12	A	0.5	









Selection and ordering data

		Version	MW	Order No.	Price 1 unit	PG	Weight 1 unit approx. kg	PS*/ P. unit Unit(s)
Auxiliary switches (AS) for 5SY6 ...-KV								
		1 NO + 1 NC	0.5	5ST3 018-0KV		027	0.037	1 unit
Fault signal contacts (FC) for 5SY6 ...-KV								
		2 CO	0.5	5ST3 028-0KV		027	0.050	1 unit

Application

- U_n : 230/400 V, 50 to 60 Hz, can be used in systems up to 250/440 V AC, 60 V DC per pole
- Standards: EN 60898, DIN VDE 0641 Part 11, IEC 60898
- Additional components can be retrofitted.

Selection and ordering data

	I_n A	MW	Characteristic B		PG	Weight 1 unit approx. kg	PS*/ P. unit Unit(s)
			Order No.	Price 1 unit			
 <p>1-pole¹⁾</p> 	2	1	5SY6 102-6		002	0.165	1 unit
	4		5SY6 104-6				
	6 ¹⁾		5SJ6 106-6				
	6		5SY6 106-6				
	10 ¹⁾		5SJ6 110-6				
	10		5SY6 110-6				
	13		5SY6 113-6				
	16 ¹⁾		5SJ6 116-6				
	16		5SY6 116-6				
	20 ¹⁾		5SJ6 120-6				
	20		5SY6 120-6				
	25 ¹⁾		5SJ6 125-6				
	25		5SY6 125-6				
	32 ¹⁾²⁾		5SJ6 132-6				
	32 ²⁾		5SY6 132-6				
	40		5SY6 140-6				
50	5SY6 150-6						
63	5SY6 163-6						
002							
 <p>1-pole + N</p> 	6	2	5SY6 506-6		002	0.330	1 unit
	10		5SY6 510-6				
	13		5SY6 513-6				
	16		5SY6 516-6				
	20		5SY6 520-6				
	25		5SY6 525-6				
	32		5SY6 532-6				
	40		5SY6 540-6				
	50		5SY6 550-6				
	63		5SY6 563-6				
	002						
 <p>2-pole</p> 	6	2	5SY6 206-6		002	0.330	1 unit
	10		5SY6 210-6				
	13		5SY6 213-6				
	16		5SY6 216-6				
	20		5SY6 220-6				
	25		5SY6 225-6				
	32		5SY6 232-6				
	40		5SY6 240-6				
	50		5SY6 250-6				
	63		5SY6 263-6				
	002						
 <p>3-pole</p> 	6	3	5SY6 306-6		002	0.495	1 unit
	10		5SY6 310-6				
	13		5SY6 313-6				
	16		5SY6 316-6				
	20		5SY6 320-6				
	25		5SY6 325-6				
	32 ²⁾		5SY6 332-6				
	40		5SY6 340-6				
	50		5SY6 350-6				
	63		5SY6 363-6				
	002						

The 5SY6 versions are certified according to UL 1077 and CSA 22.2 No. 235-M 89 and can be installed as "supplementary protectors" up to 277 V AC (1-pole, 1-pole + N) and 480 V AC (2-pole, 3-pole, 3-pole + N, 4-pole).

- 1) Type 5SJ6 1...-6: no additional components can be mounted.
- 2) Also suitable for 21 kW active power at a 3-phase current of 400 V (e.g. continuous-flow water heater with short-time operation) and 7 kW active power at 230 V AC (e.g. hot water storage tank in non-continuous operation). For continuous load applications, the use of miniature circuit-breakers of characteristic B or C and $I_n = 40$ A is recommended.



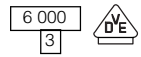

* You can order this quantity or a multiple thereof.

Miniature Circuit-Breakers Standard Product Range



5SY6, 6 kA

Selection and ordering data







	I_n	MW	Characteristic B		PG	Weight 1 unit approx.	PS*/ P. unit
			Order No.	Price 1 unit			
 <p>3-pole + N</p> 	A					kg	Unit(s)
	6	4	5SY6 606-6		002	0.660	1 unit
	10		5SY6 610-6		002	0.660	1 unit
	13		5SY6 613-6		002	0.660	1 unit
	16		5SY6 616-6		002	0.660	1 unit
	20		5SY6 620-6		002	0.660	1 unit
	25		5SY6 625-6		002	0.660	1 unit
	32		5SY6 632-6		002	0.660	1 unit
	40		5SY6 640-6		002	0.660	1 unit
	50		5SY6 650-6		002	0.660	1 unit
	63		5SY6 663-6		002	0.660	1 unit
 <p>4-pole</p> 		4					
	6		5SY6 406-6		002	0.660	1 unit
	10		5SY6 410-6		002	0.660	1 unit
	13		5SY6 413-6		002	0.660	1 unit
	16		5SY6 416-6		002	0.660	1 unit
	20		5SY6 420-6		002	0.660	1 unit
	25		5SY6 425-6		002	0.660	1 unit
	32		5SY6 432-6		002	0.660	1 unit
	40		5SY6 440-6		002	0.660	1 unit
	50		5SY6 450-6		002	0.660	1 unit
	63		5SY6 463-6		002	0.660	1 unit

The 5SY6 versions are certified according to UL 1077 and CSA 22.2 No. 235-M 89 and can be installed as "supplementary protectors" up to 277 V AC (1-pole, 1-pole + N) and 480 V AC (2-pole, 3-pole, 3-pole + N, 4-pole).

Application

- U_n : 230/400 V, 50 to 60 Hz, can be used in systems up to 250/440 V AC, 60 V DC per pole
- Standards: EN 60898, DIN VDE 0641 Part 11, IEC 60898
- Additional components can be retrofitted.

Selection and ordering data

	I_n	MW	Characteristic C		PG	Characteristic D		PG	Weight 1 unit approx.	PS/ P. unit
			Order No.	Price 1 unit		Order No.	Price 1 unit			
 <p>1-pole</p> 	A									
	0.3	1	5SY6 114-7		003	5SY6 114-8		004	0.165	1 unit
	0.5		5SY6 105-7		003	5SY6 105-8		004	0.165	1 unit
	1		5SY6 101-7		003	5SY6 101-8		004	0.165	1 unit
	1.6		5SY6 115-7		003	5SY6 115-8		004	0.147	1 unit
	2		5SY6 102-7		003	5SY6 102-8		004	0.165	1 unit
	3		5SY6 103-7		003	5SY6 103-8		004	0.165	1 unit
	4		5SY6 104-7		003	5SY6 104-8		004	0.165	1 unit
	6		5SY6 106-7		003	5SY6 106-8		004	0.165	1 unit
	8		5SY6 108-7		003	5SY6 108-8		004	0.165	1 unit
	10		5SY6 110-7		003	5SY6 110-8		004	0.165	1 unit
	13		5SY6 113-7		003	5SY6 113-8		004	0.165	1 unit
	16		5SY6 116-7		003	5SY6 116-8		004	0.165	1 unit
	20		5SY6 120-7		003	5SY6 120-8		004	0.165	1 unit
	25		5SY6 125-7		003	5SY6 125-8		004	0.165	1 unit
	32 ¹⁾		5SY6 132-7		003	5SY6 132-8		004	0.165	1 unit
40		5SY6 140-7		003	5SY6 140-8		004	0.165	1 unit	
50		5SY6 150-7		003	5SY6 150-8		004	0.165	1 unit	
63		5SY6 163-7		003	5SY6 163-8		004	0.165	1 unit	
 <p>1-pole + N</p> 	0.3	2	5SY6 514-7		003	5SY6 514-8		004	0.330	1 unit
	0.5		5SY6 505-7		003	5SY6 505-8		004	0.330	1 unit
	1		5SY6 501-7		003	5SY6 501-8		004	0.330	1 unit
	1.6		5SY6 515-7		003	5SY6 515-8		004	0.330	1 unit
	2		5SY6 502-7		003	5SY6 502-8		004	0.330	1 unit
	3		5SY6 503-7		003	5SY6 503-8		004	0.330	1 unit
	4		5SY6 504-7		003	5SY6 504-8		004	0.330	1 unit
	6		5SY6 506-7		003	5SY6 506-8		004	0.330	1 unit
	8		5SY6 508-7		003	5SY6 508-8		004	0.330	1 unit
	10		5SY6 510-7		003	5SY6 510-8		004	0.330	1 unit
	13		5SY6 513-7		003	5SY6 513-8		004	0.330	1 unit
	16		5SY6 516-7		003	5SY6 516-8		004	0.330	1 unit
	20		5SY6 520-7		003	5SY6 520-8		004	0.330	1 unit
	25		5SY6 525-7		003	5SY6 525-8		004	0.330	1 unit
	32		5SY6 532-7		003	5SY6 532-8		004	0.330	1 unit
	40		5SY6 540-7		003	5SY6 540-8		004	0.330	1 unit
50		5SY6 550-7		003	5SY6 550-8		004	0.330	1 unit	
63		5SY6 563-7		003	5SY6 563-8		004	0.330	1 unit	
 <p>2-pole</p> 	0.3	2	5SY6 214-7		003	5SY6 214-8		004	0.330	1 unit
	0.5		5SY6 205-7		003	5SY6 205-8		004	0.330	1 unit
	1		5SY6 201-7		003	5SY6 201-8		004	0.330	1 unit
	1.6		5SY6 215-7		003	5SY6 215-8		004	0.330	1 unit
	2		5SY6 202-7		003	5SY6 202-8		004	0.330	1 unit
	3		5SY6 203-7		003	5SY6 203-8		004	0.330	1 unit
	4		5SY6 204-7		003	5SY6 204-8		004	0.330	1 unit
	6		5SY6 206-7		003	5SY6 206-8		004	0.330	1 unit
	8		5SY6 208-7		003	5SY6 208-8		004	0.330	1 unit
	10		5SY6 210-7		003	5SY6 210-8		004	0.330	1 unit
	13		5SY6 213-7		003	5SY6 213-8		004	0.330	1 unit
	16		5SY6 216-7		003	5SY6 216-8		004	0.330	1 unit
	20		5SY6 220-7		003	5SY6 220-8		004	0.330	1 unit
	25		5SY6 225-7		003	5SY6 225-8		004	0.330	1 unit
	32		5SY6 232-7		003	5SY6 232-8		004	0.330	1 unit
	40		5SY6 240-7		003	5SY6 240-8		004	0.330	1 unit
50		5SY6 250-7		003	5SY6 250-8		004	0.330	1 unit	
63		5SY6 263-7		003	5SY6 263-8		004	0.330	1 unit	

The 5SY6 versions are certified according to UL 1077 and CSA 22.2 No. 235-M 89 and can be installed as "supplementary protectors" up to 277 V AC (1-pole, 1-pole + N) and 480 V AC (2-pole, 3-pole, 3-pole + N, 4-pole).





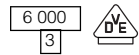

1) Also suitable for 21 kW active power at a 3-phase current of 400 V (e.g. continuous-flow water heater with short-time operation) and 7 kW active power at 230 V AC (e.g. hot water storage tank in non-continuous operation). For continuous load applications, the use of miniature circuit-breakers of characteristic B or C and $I_n = 40$ A is recommended.

* You can order this quantity or a multiple thereof.

Miniature Circuit-Breakers Standard Product Range



5SY6, 6 kA

	I_n	MW	Characteristic C		PG	Characteristic D		PG	Weight 1 unit approx.	PS*/ P. unit
			Order No.	Price 1 unit		Order No.	Price 1 unit			
 <p>3-pole</p> 	A									
	0.3	3	5SY6 314-7		003	5SY6 314-8		004	0.495	1 unit
	0.5		5SY6 305-7		003	5SY6 305-8		004	0.495	1 unit
	1		5SY6 301-7		003	5SY6 301-8		004	0.495	1 unit
	1.6		5SY6 315-7		003	5SY6 315-8		004	0.495	1 unit
	2		5SY6 302-7		003	5SY6 302-8		004	0.495	1 unit
	3		5SY6 303-7		003	5SY6 303-8		004	0.495	1 unit
	4		5SY6 304-7		003	5SY6 304-8		004	0.495	1 unit
	6		5SY6 306-7		003	5SY6 306-8		004	0.495	1 unit
	8		5SY6 308-7		003	5SY6 308-8		004	0.495	1 unit
	10		5SY6 310-7		003	5SY6 310-8		004	0.495	1 unit
	13		5SY6 313-7		003	5SY6 313-8		004	0.495	1 unit
	16		5SY6 316-7		003	5SY6 316-8		004	0.495	1 unit
	20		5SY6 320-7		003	5SY6 320-8		004	0.495	1 unit
	25		5SY6 325-7		003	5SY6 325-8		004	0.495	1 unit
	32 ¹⁾		5SY6 332-7		003	5SY6 332-8		004	0.495	1 unit
40		5SY6 340-7		003	5SY6 340-8		004	0.495	1 unit	
50		5SY6 350-7		003	5SY6 350-8		004	0.495	1 unit	
63		5SY6 363-7		003	5SY6 363-8		004	0.495	1 unit	
 <p>3-pole + N</p> 	0.3	4	5SY6 614-7		003	5SY6 614-8		004	0.660	1 unit
	0.5		5SY6 605-7		003	5SY6 605-8		004	0.660	1 unit
	1		5SY6 601-7		003	5SY6 601-8		004	0.660	1 unit
	1.6		5SY6 615-7		003	5SY6 615-8		004	0.660	1 unit
	2		5SY6 602-7		003	5SY6 602-8		004	0.660	1 unit
	3		5SY6 603-7		003	5SY6 603-8		004	0.660	1 unit
	4		5SY6 604-7		003	5SY6 604-8		004	0.660	1 unit
	6		5SY6 606-7		003	5SY6 606-8		004	0.660	1 unit
	8		5SY6 608-7		003	5SY6 608-8		004	0.660	1 unit
	10		5SY6 610-7		003	5SY6 610-8		004	0.660	1 unit
	13		5SY6 613-7		003	5SY6 613-8		004	0.660	1 unit
	16		5SY6 616-7		003	5SY6 616-8		004	0.660	1 unit
	20		5SY6 620-7		003	5SY6 620-8		004	0.660	1 unit
	25		5SY6 625-7		003	5SY6 625-8		004	0.660	1 unit
	32		5SY6 632-7		003	5SY6 632-8		004	0.660	1 unit
	40		5SY6 640-7		003	5SY6 640-8		004	0.660	1 unit
50		5SY6 650-7		003	5SY6 650-8		004	0.660	1 unit	
63		5SY6 663-7		003	5SY6 663-8		004	0.660	1 unit	
 <p>4-pole</p> 	0.3	4	5SY6 414-7		003	5SY6 414-8		004	0.660	1 unit
	0.5		5SY6 405-7		003	5SY6 405-8		004	0.660	1 unit
	1		5SY6 401-7		003	5SY6 401-8		004	0.660	1 unit
	1.6		5SY6 415-7		003	5SY6 415-8		004	0.660	1 unit
	2		5SY6 402-7		003	5SY6 402-8		004	0.660	1 unit
	3		5SY6 403-7		003	5SY6 403-8		004	0.660	1 unit
	4		5SY6 404-7		003	5SY6 404-8		004	0.660	1 unit
	6		5SY6 406-7		003	5SY6 406-8		004	0.660	1 unit
	8		5SY6 408-7		003	5SY6 408-8		004	0.660	1 unit
	10		5SY6 410-7		003	5SY6 410-8		004	0.660	1 unit
	13		5SY6 413-7		003	5SY6 413-8		004	0.660	1 unit
	16		5SY6 416-7		003	5SY6 416-8		004	0.660	1 unit
	20		5SY6 420-7		003	5SY6 420-8		004	0.660	1 unit
	25		5SY6 425-7		003	5SY6 425-8		004	0.660	1 unit
	32		5SY6 432-7		003	5SY6 432-8		004	0.660	1 unit
	40		5SY6 440-7		003	5SY6 440-8		004	0.660	1 unit
50		5SY6 450-7		003	5SY6 450-8		004	0.660	1 unit	
63		5SY6 463-7		003	5SY6 463-8		004	0.660	1 unit	

The 5SY6 versions are certified according to UL 1077 and CSA 22.2 No. 235-M 89 and can be installed as "supplementary protectors" up to 277 V AC (1-pole, 1-pole + N) and 480 V AC (2-pole, 3-pole, 3-pole + N, 4-pole).

1) Also suitable for 21 kW active power at a 3-phase current of 400 V (e.g. continuous-flow water heater with short-time operation) and 7 kW active power at 230 V AC (e.g. hot water storage tank in non-continuous operation). For continuous load applications, the use of miniature circuit-breakers of characteristic B or C and $I_n = 40$ A is recommended.

Miniature Circuit-Breakers Standard Product Range

5SJ6 ...-KS, 6 kA

Benefits

- Faster and reliable connection of load circuits using screwless pair of terminals on the outgoing feeder side
- No end sleeve required when using flexible conductors
- Excellent touch protection according to VBG4/BGV A2
- Easy voltage testing through test opening on outgoing feeder side
- Full compatibility with all other 5SJ and 5SY miniature circuit-breakers.







Application

- U_n : 230/400 V, 50 to 60 Hz, can be used in systems up to 250/440 V AC, 60 V DC per pole
- Standards: EN 60898, DIN VDE 0641 Part 11, IEC 60898
- Particularly suitable for use in residential buildings.

Function

- Double, screwless outgoing terminal for rigid and flexible conductor from 1.5 to 4 mm²
- Conductors can be detached and removed by hand without the help of tools

Selection and ordering data

	I_n	MW	Characteristic B		PG	Characteristic C		PG	Weight 1 unit approx. kg	PS*/ P. unit Unit(s)
			Order No.	Price 1 unit		Order No.	Price 1 unit			
 <p>1-pole</p> 	A									
	10	1	5SJ6 110-6KS		002	5SJ6 110-7KS		003	0.111	1 unit
	13		5SJ6 113-6KS		002	5SJ6 113-7KS		003	0.111	1 unit
	16		5SJ6 116-6KS		002	5SJ6 116-7KS		003	0.111	1 unit
	20		5SJ6 120-6KS		002	5SJ6 120-7KS		003	0.111	1 unit
 <p>1-pole + N</p> 	10	2	5SJ6 510-6KS		002	5SJ6 510-7KS		003	0.185	1 unit
	13		5SJ6 513-6KS		002	5SJ6 513-7KS		003	0.185	1 unit
	16		5SJ6 516-6KS		002	5SJ6 516-7KS		003	0.185	1 unit
	20		5SJ6 520-6KS		002	5SJ6 520-7KS		003	0.185	1 unit
 <p>2-pole</p> 	10	2	5SJ6 210-6KS		002	5SJ6 210-7KS		003	0.225	1 unit
	13		5SJ6 213-6KS		002	5SJ6 213-7KS		003	0.225	1 unit
	16		5SJ6 216-6KS		002	5SJ6 216-7KS		003	0.225	1 unit
	20		5SJ6 220-6KS		002	5SJ6 220-7KS		003	0.225	1 unit

* You can order this quantity or a multiple thereof.

Miniature Circuit-Breakers High-Capacity Product Range



5SJ4 ...-HG40, 15 kA

Benefits

- Can be used in the entire NEMA field according to UL 489 or CSA C22.2 No. 5-02 "Branch Circuit Protection", no restriction due to back-up protection
- Can be used for "Field Wiring" applications, AWG 4 to AWG 14, Cu only
- For all applications in residential, non-residential and industrial buildings

Application

- U_n : 240 V, 50 to 60 Hz, can be used in systems up to 250/440 V AC, 60 V DC per pole
- Can be used in systems up to
 - 240 V AC, switching capacity 15 kA,
 - 60 V AC, switching capacity 10 kA
- Standards: UL 489, CSA C22.2 No. 5-02.

Selection and ordering data

	I_n	MW	Characteristic B		PG	Weight 1 unit approx.	PS*/ P. unit
			Order No.	Price 1 unit			
 <p>1-pole</p> <p>1 2</p>	A					kg	Unit(s)
	6	1	5SJ4 106-6HG40		002	0.120	1 unit
	10		5SJ4 110-6HG40		002	0.120	1 unit
	13		5SJ4 113-6HG40		002	0.120	1 unit
	15		5SJ4 118-6HG40		002	0.120	1 unit
	16		5SJ4 116-6HG40		002	0.120	1 unit
	20		5SJ4 120-6HG40		002	0.120	1 unit
	25		5SJ4 125-6HG40		002	0.120	1 unit
	30		5SJ4 130-6HG40		002	0.120	1 unit
	32		5SJ4 132-6HG40		002	0.120	1 unit
	35		5SJ4 135-6HG40		002	0.120	1 unit
	40		5SJ4 140-6HG40		002	0.120	1 unit
	45		5SJ4 145-6HG40		002	0.120	1 unit
	50		5SJ4 150-6HG40		002	0.120	1 unit
	60		5SJ4 160-6HG40		002	0.120	1 unit
	63		5SJ4 163-6HG40		002	0.120	1 unit



	I_n	MW	Characteristic C		PG	Characteristic D		Weight 1 unit approx.	PS*/ P. unit	
			Order No.	Price 1 unit		Order No.	Price 1 unit			
 <p>1-pole</p> <p>1 2</p>	A							kg	Unit(s)	
	0.3	1	5SJ4 114-7HG40		003	5SJ4 114-8HG40		004	0.120	1 unit
	0.5		5SJ4 105-7HG40		003	5SJ4 105-8HG40		004	0.120	1 unit
	1		5SJ4 101-7HG40		003	5SJ4 101-8HG40		004	0.120	1 unit
	1.6		5SJ4 115-7HG40		003	5SJ4 115-8HG40		004	0.120	1 unit
	2		5SJ4 102-7HG40		003	5SJ4 102-8HG40		004	0.120	1 unit
	3		5SJ4 103-7HG40		003	5SJ4 103-8HG40		004	0.120	1 unit
	4		5SJ4 104-7HG40		003	5SJ4 104-8HG40		004	0.120	1 unit
	5		5SJ4 111-7HG40		003	5SJ4 111-8HG40		004	0.120	1 unit
	6		5SJ4 106-7HG40		003	5SJ4 106-8HG40		004	0.120	1 unit
	8		5SJ4 108-7HG40		003	5SJ4 108-8HG40		004	0.120	1 unit
	10		5SJ4 110-7HG40		003	5SJ4 110-8HG40		004	0.120	1 unit
	13		5SJ4 113-7HG40		003	5SJ4 113-8HG40		004	0.120	1 unit
	15		5SJ4 118-7HG40		003	5SJ4 118-8HG40		004	0.120	1 unit
	16		5SJ4 116-7HG40		003	5SJ4 116-8HG40		004	0.120	1 unit
	20		5SJ4 120-7HG40		003	5SJ4 120-8HG40		004	0.120	1 unit
	25		5SJ4 125-7HG40		003	5SJ4 125-8HG40		004	0.120	1 unit
	30		5SJ4 130-7HG40		003	5SJ4 130-8HG40		004	0.120	1 unit
	32		5SJ4 132-7HG40		003	5SJ4 132-8HG40		004	0.120	1 unit
35		5SJ4 135-7HG40		003	5SJ4 135-8HG40		004	0.120	1 unit	
40		5SJ4 140-7HG40		003	5SJ4 140-8HG40		004	0.120	1 unit	
45		5SJ4 145-7HG40		003	5SJ4 145-8HG40		004	0.120	1 unit	
50		5SJ4 150-7HG40		003	5SJ4 150-8HG40		004	0.120	1 unit	
60		5SJ4 160-7HG40		003	5SJ4 160-8HG40		004	0.120	1 unit	
63		5SJ4 163-7HG40		003	5SJ4 163-8HG40		004	0.120	1 unit	

Application

- U_n : 230/400 V, 50 to 60 Hz, can be used in systems up to 250/440 V AC, 60 V DC per pole
- Standards: EN 60898, DIN VDE 0641 Part 11, IEC 60898

- Additional components can be retrofitted.

Selection and ordering data

	I_n	MW	Characteristic A		PG	Characteristic B		PG	Weight 1 unit approx.	PS/ P. unit
			Order No.	Price 1 unit		Order No.	Price 1 unit			
1-pole										
			A							
		1	1	5SY4 101-5		001	--		0.165	1 unit
		1.6		5SY4 115-5		001	--		0.165	1 unit
		2		5SY4 102-5		001	--		0.165	1 unit
		3		5SY4 103-5		001	--		0.165	1 unit
		4		5SY4 104-5		001	--		0.165	1 unit
		6		5SY4 106-5		001	5SY4 106-6	002	0.165	1 unit
		8		5SY4 108-5		001	--		0.165	1 unit
		10		5SY4 110-5		001	5SY4 110-6	002	0.165	1 unit
		13		5SY4 113-5		001	5SY4 113-6	002	0.165	1 unit
		16		5SY4 116-5		001	5SY4 116-6	002	0.165	1 unit
		20		5SY4 120-5		001	5SY4 120-6	002	0.165	1 unit
		25		5SY4 125-5		001	5SY4 125-6	002	0.165	1 unit
		32 ¹⁾		5SY4 132-5		001	5SY4 132-6	002	0.165	1 unit
		40		5SY4 140-5		001	5SY4 140-6	002	0.165	1 unit
	50		5SY4 150-5		001	5SY4 150-6	002	0.165	1 unit	
	63		5SY4 163-5		001	5SY4 163-6	002	0.165	1 unit	
	80 ²⁾		--			5SY4 180-6	002	0.162	1 unit	
1-pole + N										
										
		1	2	5SY4 501-5		001	--		0.330	1 unit
		1.6		5SY4 515-5		001	--		0.330	1 unit
		2		5SY4 502-5		001	--		0.330	1 unit
		3		5SY4 503-5		001	--		0.330	1 unit
		4		5SY4 504-5		001	--		0.330	1 unit
		6		5SY4 506-5		001	5SY4 506-6	002	0.330	1 unit
		8		5SY4 508-5		001	--		0.330	1 unit
		10		5SY4 510-5		001	5SY4 510-6	002	0.330	1 unit
		13		5SY4 513-5		001	5SY4 513-6	002	0.330	1 unit
		16		5SY4 516-5		001	5SY4 516-6	002	0.330	1 unit
		20		5SY4 520-5		001	5SY4 520-6	002	0.330	1 unit
		25		5SY4 525-5		001	5SY4 525-6	002	0.330	1 unit
		32		5SY4 532-5		001	5SY4 532-6	002	0.330	1 unit
		40		5SY4 540-5		001	5SY4 540-6	002	0.330	1 unit
	50		5SY4 550-5		001	5SY4 550-6	002	0.330	1 unit	
	63		5SY4 563-5		001	5SY4 563-6	002	0.330	1 unit	
2-pole										
										
		1	2	5SY4 201-5		001	--		0.330	1 unit
		1.6		5SY4 215-5		001	--		0.330	1 unit
		2		5SY4 202-5		001	--		0.330	1 unit
		3		5SY4 203-5		001	--		0.330	1 unit
		4		5SY4 204-5		001	--		0.330	1 unit
		6		5SY4 206-5		001	5SY4 206-6	002	0.330	1 unit
		8		5SY4 208-5		001	--		0.330	1 unit
		10		5SY4 210-5		001	5SY4 210-6	002	0.330	1 unit
		13		5SY4 213-5		001	5SY4 213-6	002	0.330	1 unit
		16		5SY4 216-5		001	5SY4 216-6	002	0.330	1 unit
		20		5SY4 220-5		001	5SY4 220-6	002	0.330	1 unit
		25		5SY4 225-5		001	5SY4 225-6	002	0.330	1 unit
		32		5SY4 232-5		001	5SY4 232-6	002	0.330	1 unit
		40		5SY4 240-5		001	5SY4 240-6	002	0.330	1 unit
	50		5SY4 250-5		001	5SY4 250-6	002	0.330	1 unit	
	63		5SY4 263-5		001	5SY4 263-6	002	0.330	1 unit	
	80 ²⁾		--			5SY4 280-6	002	0.324	1 unit	

The 5SY4 versions are certified according to UL 1077 and CSA 22.2 No. 235-M 89 and can be installed as "supplementary protectors" up to 277 V AC (1-pole, 1-pole + N) and 480 V AC (2-pole, 3-pole, 3-pole + N, 4-pole).

1) Applies only for 5SY4 132-6:



Also suitable for 21 kW active power at a 3-phase current of 400 V (e.g. continuous-flow water heater with short-time operation) and 7 kW active power at 230 V AC (e.g. hot water storage tank in non-continuous operation). For continuous load applications, the use of miniature circuit-breakers of characteristic B or C and $I_n = 40$ A is recommended.

2) No .

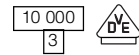
Miniature Circuit-Breakers High-Capacity Product Range



5SY4, 10 kA

	I_n	MW	Characteristic A		PG	Characteristic B		PG	Weight 1 unit approx.	PS*/ P. unit	
			Order No.	Price 1 unit		Order No.	Price 1 unit				
3-pole											
											
		1	3	5SY4 301-5		001	--		0.495	1 unit	
		1.6		5SY4 315-5		001	--		0.495	1 unit	
		2		5SY4 302-5		001	--		0.495	1 unit	
		3		5SY4 303-5		001	--		0.495	1 unit	
		4		5SY4 304-5		001	--		0.495	1 unit	
		6		5SY4 306-5		001	--		0.495	1 unit	
		8		5SY4 308-5		001	--		0.495	1 unit	
		10		5SY4 310-5		001	5SY4 310-6		002	0.495	1 unit
		13		5SY4 313-5		001	5SY4 313-6		002	0.495	1 unit
		16		5SY4 316-5		001	5SY4 316-6		002	0.495	1 unit
		20		5SY4 320-5		001	5SY4 320-6		002	0.495	1 unit
		25		5SY4 325-5		001	5SY4 325-6		002	0.495	1 unit
		32 ¹⁾		5SY4 332-5		001	5SY4 332-6		002	0.495	1 unit
		40		5SY4 340-5		001	5SY4 340-6		002	0.495	1 unit
		50		5SY4 350-5		001	5SY4 350-6		002	0.495	1 unit
	63 ²⁾		5SY4 363-5		001	5SY4 363-6		002	0.495	1 unit	
	80 ²⁾		--			5SY4 380-6		002	0.486	1 unit	
3-pole + N											
											
		1	4	5SY4 601-5		001	--		0.660	1 unit	
		1.6		5SY4 615-5		001	--		0.660	1 unit	
		2		5SY4 602-5		001	--		0.660	1 unit	
		3		5SY4 603-5		001	--		0.660	1 unit	
		4		5SY4 604-5		001	--		0.660	1 unit	
		6		5SY4 606-5		001	5SY4 606-6		002	0.660	1 unit
		8		5SY4 608-5		001	--		0.660	1 unit	
		10		5SY4 610-5		001	5SY4 610-6		002	0.660	1 unit
		13		5SY4 613-5		001	5SY4 613-6		002	0.660	1 unit
		16		5SY4 616-5		001	5SY4 616-6		002	0.660	1 unit
		20		5SY4 620-5		001	5SY4 620-6		002	0.660	1 unit
		25		5SY4 625-5		001	5SY4 625-6		002	0.660	1 unit
		32		5SY4 632-5		001	5SY4 632-6		002	0.660	1 unit
	40		5SY4 640-5		001	5SY4 640-6		002	0.660	1 unit	
	50		5SY4 650-5		001	5SY4 650-6		002	0.660	1 unit	
	63		5SY4 663-5		001	5SY4 663-6		002	0.660	1 unit	
4-pole											
											
		1	4	5SY4 401-5		001	--		0.660	1 unit	
		1.6		5SY4 415-5		001	--		0.660	1 unit	
		2		5SY4 402-5		001	--		0.660	1 unit	
		3		5SY4 403-5		001	--		0.660	1 unit	
		4		5SY4 404-5		001	--		0.660	1 unit	
		6		5SY4 406-5		001	5SY4 406-6		002	0.660	1 unit
		8		5SY4 408-5		001	--		0.660	1 unit	
		10		5SY4 410-5		001	5SY4 410-6		002	0.660	1 unit
		13		5SY4 413-5		001	5SY4 413-6		002	0.660	1 unit
		16		5SY4 416-5		001	5SY4 416-6		002	0.660	1 unit
		20		5SY4 420-5		001	5SY4 420-6		002	0.660	1 unit
		25		5SY4 425-5		001	5SY4 425-6		002	0.660	1 unit
		32		5SY4 432-5		001	5SY4 432-6		002	0.660	1 unit
		40		5SY4 440-5		001	5SY4 440-6		002	0.660	1 unit
		50		5SY4 450-5		001	5SY4 450-6		002	0.660	1 unit
	63		5SY4 463-5		001	5SY4 463-6		002	0.660	1 unit	
	80 ²⁾		--			5SY4 480-6		002	0.648	1 unit	

The 5SY4 versions are certified according to UL 1077 and CSA 22.2 No. 235-M 89 and can be installed as "supplementary protectors" up to 277 V AC (1-pole, 1-pole + N) and 480 V AC (2-pole, 3-pole, 3-pole + N, 4-pole).







1) Applies only for 5SY4 332-6:

Also suitable for 21 kW active power at a 3-phase current of 400 V (e.g. continuous-flow water heater with short-time operation) and 7 kW active power at 230 V AC (e.g. hot water storage tank in non-continuous operation). For continuous load applications, the use of miniature circuit-breakers of characteristic B or C and $I_n = 40$ A is recommended.

2) No .

Miniature Circuit-Breakers High-Capacity Product Range

5SY4, 10 kA

	I_n	MW	Characteristic C		PG	Characteristic D		PG	Weight 1 unit approx. kg	PS*/ P. unit Unit(s)
			Order No.	Price 1 unit		Order No.	Price 1 unit			
 <p>1-pole</p> 	A	1								
	0.3		5SY4 114-7		003	5SY4 114-8		004	0.165	1 unit
	0.5		5SY4 105-7		003	5SY4 105-8		004	0.165	1 unit
	1		5SY4 101-7		003	5SY4 101-8		004	0.165	1 unit
	1.6		5SY4 115-7		003	5SY4 115-8		004	0.165	1 unit
	2		5SY4 102-7		003	5SY4 102-8		004	0.165	1 unit
	3		5SY4 103-7		003	5SY4 103-8		004	0.165	1 unit
	4		5SY4 104-7		003	5SY4 104-8		004	0.165	1 unit
	6		5SY4 106-7		003	5SY4 106-8		004	0.165	1 unit
	8		5SY4 108-7		003	5SY4 108-8		004	0.165	1 unit
	10		5SY4 110-7		003	5SY4 110-8		004	0.165	1 unit
	13		5SY4 113-7		003	5SY4 113-8		004	0.165	1 unit
	16		5SY4 116-7		003	5SY4 116-8		004	0.165	1 unit
	20		5SY4 120-7		003	5SY4 120-8		004	0.165	1 unit
	25		5SY4 125-7		003	5SY4 125-8		004	0.165	1 unit
	32 ¹⁾		5SY4 132-7		003	5SY4 132-8		004	0.165	1 unit
	40		5SY4 140-7		003	5SY4 140-8		004	0.165	1 unit
50		5SY4 150-7		003	5SY4 150-8		004	0.165	1 unit	
63		5SY4 163-7		003	5SY4 163-8		004	0.165	1 unit	
80 ²⁾		5SY4 180-7		003	--		004	0.161	1 unit	
 <p>1-pole + N</p> 										
	0.3		5SY4 514-7		003	5SY4 514-8		004	0.330	1 unit
	0.5		5SY4 505-7		003	5SY4 505-8		004	0.330	1 unit
	1		5SY4 501-7		003	5SY4 501-8		004	0.330	1 unit
	1.6		5SY4 515-7		003	5SY4 515-8		004	0.330	1 unit
	2		5SY4 502-7		003	5SY4 502-8		004	0.330	1 unit
	3		5SY4 503-7		003	5SY4 503-8		004	0.330	1 unit
	4		5SY4 504-7		003	5SY4 504-8		004	0.330	1 unit
	6		5SY4 506-7		003	5SY4 506-8		004	0.330	1 unit
	8		5SY4 508-7		003	5SY4 508-8		004	0.330	1 unit
	10		5SY4 510-7		003	5SY4 510-8		004	0.330	1 unit
	13		5SY4 513-7		003	5SY4 513-8		004	0.330	1 unit
	16		5SY4 516-7		003	5SY4 516-8		004	0.330	1 unit
	20		5SY4 520-7		003	5SY4 520-8		004	0.330	1 unit
	25		5SY4 525-7		003	5SY4 525-8		004	0.330	1 unit
	32		5SY4 532-7		003	5SY4 532-8		004	0.330	1 unit
	40		5SY4 540-7		003	5SY4 540-8		004	0.330	1 unit
50		5SY4 550-7		003	5SY4 550-8		004	0.330	1 unit	
63		5SY4 563-7		003	5SY4 563-8		004	0.330	1 unit	
80 ²⁾		5SY4 580-7		003	--		004	0.345	1 unit	
 <p>2-pole</p> 										
	0.3		5SY4 214-7		003	5SY4 214-8		004	0.330	1 unit
	0.5		5SY4 205-7		003	5SY4 205-8		004	0.330	1 unit
	1		5SY4 201-7		003	5SY4 201-8		004	0.330	1 unit
	1.6		5SY4 215-7		003	5SY4 215-8		004	0.330	1 unit
	2		5SY4 202-7		003	5SY4 202-8		004	0.330	1 unit
	3		5SY4 203-7		003	5SY4 203-8		004	0.330	1 unit
	4		5SY4 204-7		003	5SY4 204-8		004	0.330	1 unit
	6		5SY4 206-7		003	5SY4 206-8		004	0.330	1 unit
	8		5SY4 208-7		003	5SY4 208-8		004	0.330	1 unit
	10		5SY4 210-7		003	5SY4 210-8		004	0.330	1 unit
	13		5SY4 213-7		003	5SY4 213-8		004	0.330	1 unit
	16		5SY4 216-7		003	5SY4 216-8		004	0.330	1 unit
	20		5SY4 220-7		003	5SY4 220-8		004	0.330	1 unit
	25		5SY4 225-7		003	5SY4 225-8		004	0.330	1 unit
	32		5SY4 232-7		003	5SY4 232-8		004	0.330	1 unit
	40		5SY4 240-7		003	5SY4 240-8		004	0.330	1 unit
50		5SY4 250-7		003	5SY4 250-8		004	0.330	1 unit	
63		5SY4 263-7		003	5SY4 263-8		004	0.330	1 unit	
80 ²⁾		5SY4 280-7		003	--		004	0.323	1 unit	

The 5SY4 versions are certified according to UL 1077 and CSA 22.2 No. 235-M 89 and can be installed as "supplementary protectors" up to 277 V AC (1-pole, 1-pole + N) and 480 V AC (2-pole, 3-pole, 3-pole + N, 4-pole).





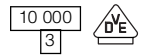

1) Applies only for 5SY4 132-7:
Also suitable for 21 kW active power at a 3-phase current of 400 V (e.g. continuous-flow water heater with short-time operation) and 7 kW active power at 230 V AC (e.g. hot water storage tank in non-continuous operation). For continuous load applications, the use of miniature circuit-breakers of characteristic B or C and $I_n = 40$ A is recommended.

2) No .

Miniature Circuit-Breakers High-Capacity Product Range



5SY4, 10 kA

	I_n	MW	Characteristic C		PG	Characteristic D		PG	Weight 1 unit approx.	PS*/ P. unit
			Order No.	Price 1 unit		Order No.	Price 1 unit			
 <p>3-pole</p> 	A	3								
	0.3		5SY4 314-7		003	5SY4 314-8		004	0.495	1 unit
	0.5		5SY4 305-7		003	5SY4 305-8		004	0.495	1 unit
	1		5SY4 301-7		003	5SY4 301-8		004	0.495	1 unit
	1.6		5SY4 315-7		003	5SY4 315-8		004	0.495	1 unit
	2		5SY4 302-7		003	5SY4 302-8		004	0.495	1 unit
	3		5SY4 303-7		003	5SY4 303-8		004	0.495	1 unit
	4		5SY4 304-7		003	5SY4 304-8		004	0.495	1 unit
	6		5SY4 306-7		003	5SY4 306-8		004	0.495	1 unit
	8		5SY4 308-7		003	5SY4 308-8		004	0.495	1 unit
	10		5SY4 310-7		003	5SY4 310-8		004	0.495	1 unit
	13		5SY4 313-7		003	5SY4 313-8		004	0.495	1 unit
	16		5SY4 316-7		003	5SY4 316-8		004	0.495	1 unit
	20		5SY4 320-7		003	5SY4 320-8		004	0.495	1 unit
	25		5SY4 325-7		003	5SY4 325-8		004	0.495	1 unit
	32 ¹⁾		5SY4 332-7		003	5SY4 332-8		004	0.495	1 unit
	40		5SY4 340-7		003	5SY4 340-8		004	0.495	1 unit
50		5SY4 350-7		003	5SY4 350-8		004	0.495	1 unit	
63		5SY4 363-7		003	5SY4 363-8		004	0.495	1 unit	
80 ²⁾		5SY4 380-7		003	—		004	0.482	1 unit	
 <p>3-pole + N</p> 	A	4								
	0.3		5SY4 614-7		003	5SY4 614-8		004	0.660	1 unit
	0.5		5SY4 605-7		003	5SY4 605-8		004	0.660	1 unit
	1		5SY4 601-7		003	5SY4 601-8		004	0.660	1 unit
	1.6		5SY4 615-7		003	5SY4 615-8		004	0.660	1 unit
	2		5SY4 602-7		003	5SY4 602-8		004	0.660	1 unit
	3		5SY4 603-7		003	5SY4 603-8		004	0.660	1 unit
	4		5SY4 604-7		003	5SY4 604-8		004	0.660	1 unit
	6		5SY4 606-7		003	5SY4 606-8		004	0.660	1 unit
	8		5SY4 608-7		003	5SY4 608-8		004	0.660	1 unit
	10		5SY4 610-7		003	5SY4 610-8		004	0.660	1 unit
	13		5SY4 613-7		003	5SY4 613-8		004	0.660	1 unit
	16		5SY4 616-7		003	5SY4 616-8		004	0.660	1 unit
	20		5SY4 620-7		003	5SY4 620-8		004	0.660	1 unit
	25		5SY4 625-7		003	5SY4 625-8		004	0.660	1 unit
	32		5SY4 632-7		003	5SY4 632-8		004	0.660	1 unit
	40		5SY4 640-7		003	5SY4 640-8		004	0.660	1 unit
50		5SY4 650-7		003	5SY4 650-8		004	0.660	1 unit	
63		5SY4 663-7		003	5SY4 663-8		004	0.660	1 unit	
80 ²⁾		5SY4 680-7		003	—		004	0.695	1 unit	
 <p>4-pole</p> 	A	4								
	0.3		5SY4 414-7		003	5SY4 414-8		004	0.660	1 unit
	0.5		5SY4 405-7		003	5SY4 405-8		004	0.660	1 unit
	1		5SY4 401-7		003	5SY4 401-8		004	0.660	1 unit
	1.6		5SY4 415-7		003	5SY4 415-8		004	0.660	1 unit
	2		5SY4 402-7		003	5SY4 402-8		004	0.660	1 unit
	3		5SY4 403-7		003	5SY4 403-8		004	0.660	1 unit
	4		5SY4 404-7		003	5SY4 404-8		004	0.660	1 unit
	6		5SY4 406-7		003	5SY4 406-8		004	0.660	1 unit
	8		5SY4 408-7		003	5SY4 408-8		004	0.660	1 unit
	10		5SY4 410-7		003	5SY4 410-8		004	0.660	1 unit
	13		5SY4 413-7		003	5SY4 413-8		004	0.660	1 unit
	16		5SY4 416-7		003	5SY4 416-8		004	0.660	1 unit
	20		5SY4 420-7		003	5SY4 420-8		004	0.660	1 unit
	25		5SY4 425-7		003	5SY4 425-8		004	0.660	1 unit
	32		5SY4 432-7		003	5SY4 432-8		004	0.660	1 unit
	40		5SY4 440-7		003	5SY4 440-8		004	0.660	1 unit
50		5SY4 450-7		003	5SY4 450-8		004	0.660	1 unit	
63		5SY4 463-7		003	5SY4 463-8		004	0.660	1 unit	
80 ²⁾		5SY4 480-7		003	—		004	0.647	1 unit	

The 5SY4 and 5SY7 versions are certified according to UL 1077 and CSA 22.2 No. 235-M 89 and can be installed as "supplementary protectors" up to 277 V AC (1-pole, 1-pole + N) and 480 V AC (2-pole, 3-pole, 3-pole + N, 4-pole).

1) Applies only for 5SY4 332-7 and 5SY7 132-6:

Also suitable for 21 kW active power at a 3-phase current of 400 V (e.g. continuous-flow water heater with short-time operation) and 7 kW active power at 230 V AC (e.g. hot water storage tank in non-continuous operation). For continuous load applications, the use of miniature circuit-breakers of characteristic B or C and $I_n = 40$ A is recommended.













2) No .

Application

- U_n : 230/400 V, 50 to 60 Hz, can be used in systems up to 250/440 V AC, 60 V DC per pole

- Standards: EN 60898, DIN VDE 0641 Part 11, IEC 60898
- Additional components can be retrofitted.

Selection and ordering data

	I_n A	MW	Characteristic B		PG	Weight 1 unit approx. kg	PS*/ P. unit Unit(s)		
			Order No.	Price 1 unit					
 <p>1-pole</p> 	6	1	5SY7 106-6		002	0.165	1 unit		
	10		5SY7 110-6		002	0.165	1 unit		
	13		5SY7 113-6		002	0.165	1 unit		
	16		5SY7 116-6		002	0.165	1 unit		
	20		5SY7 120-6		002	0.165	1 unit		
	25		5SY7 125-6		002	0.165	1 unit		
	32 ¹⁾		5SY7 132-6		002	0.165	1 unit		
	40		5SY7 140-6		002	0.165	1 unit		
	50		5SY7 150-6		002	0.165	1 unit		
63	5SY7 163-6		002	0.165	1 unit				
 <p>1-pole + N</p> 	6	2	5SY7 506-6		002	0.330	1 unit		
	10		5SY7 510-6		002	0.330	1 unit		
	13		5SY7 513-6		002	0.330	1 unit		
	16		5SY7 516-6		002	0.330	1 unit		
	20		5SY7 520-6		002	0.330	1 unit		
	25		5SY7 525-6		002	0.330	1 unit		
	32		5SY7 532-6		002	0.330	1 unit		
	40		5SY7 540-6		002	0.330	1 unit		
	50		5SY7 550-6		002	0.330	1 unit		
63	5SY7 563-6		002	0.330	1 unit				
 <p>2-pole</p> 	6	2	5SY7 206-6		002	0.330	1 unit		
	10		5SY7 210-6		002	0.330	1 unit		
	13		5SY7 213-6		002	0.330	1 unit		
	16		5SY7 216-6		002	0.330	1 unit		
	20		5SY7 220-6		002	0.330	1 unit		
	25		5SY7 225-6		002	0.330	1 unit		
	32		5SY7 232-6		002	0.330	1 unit		
	40		5SY7 240-6		002	0.330	1 unit		
	50		5SY7 250-6		002	0.330	1 unit		
	63		5SY7 263-6		002	0.330	1 unit		
	 <p>3-pole</p> 		6	3	5SY7 306-6		002	0.495	1 unit
			10		5SY7 310-6		002	0.495	1 unit
13		5SY7 313-6			002	0.495	1 unit		
16		5SY7 316-6			002	0.495	1 unit		
20		5SY7 320-6			002	0.495	1 unit		
25		5SY7 325-6			002	0.495	1 unit		
32		5SY7 332-6			002	0.495	1 unit		
40		5SY7 340-6			002	0.495	1 unit		
50		5SY7 350-6			002	0.495	1 unit		
63	5SY7 363-6		002	0.495	1 unit				
 <p>3-pole + N</p> 	6	4	5SY7 606-6		002	0.660	1 unit		
	10		5SY7 610-6		002	0.660	1 unit		
	13		5SY7 613-6		002	0.660	1 unit		
	16		5SY7 616-6		002	0.660	1 unit		
	20		5SY7 620-6		002	0.660	1 unit		
	25		5SY7 625-6		002	0.660	1 unit		
	32		5SY7 632-6		002	0.660	1 unit		
	40		5SY7 640-6		002	0.660	1 unit		
	50		5SY7 650-6		002	0.660	1 unit		
63	5SY7 663-6		002	0.660	1 unit				
 <p>4-pole</p> 	6	4	5SY7 406-6		002	0.660	1 unit		
	10		5SY7 410-6		002	0.660	1 unit		
	13		5SY7 413-6		002	0.660	1 unit		
	16		5SY7 416-6		002	0.660	1 unit		
	20		5SY7 420-6		002	0.660	1 unit		
	25		5SY7 425-6		002	0.660	1 unit		
	32		5SY7 432-6		002	0.660	1 unit		
	40		5SY7 440-6		002	0.660	1 unit		
	50		5SY7 450-6		002	0.660	1 unit		
63	5SY7 463-6		002	0.660	1 unit				





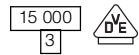

For information and footer, see next page.

* You can order this quantity or a multiple thereof.

Miniature Circuit-Breakers High-Capacity Product Range



5SY7, 15 kA

	I_n	MW	Characteristic C		PG	Characteristic D		PG	Weight 1 unit approx.	PS*/ P. unit
			Order No.	Price 1 unit		Order No.	Price 1 unit			
1-pole										
		1	0.3	5SY7 114-7	003	5SY7 114-8	004	0.165	1 unit	
			0.5	5SY7 105-7	003	5SY7 105-8	004	0.165	1 unit	
			1	5SY7 101-7	003	5SY7 101-8	004	0.165	1 unit	
			1.6	5SY7 115-7	003	5SY7 115-8	004	0.165	1 unit	
			2	5SY7 102-7	003	5SY7 102-8	004	0.165	1 unit	
			3	5SY7 103-7	003	5SY7 103-8	004	0.165	1 unit	
			4	5SY7 104-7	003	5SY7 104-8	004	0.165	1 unit	
			6	5SY7 106-7	003	5SY7 106-8	004	0.165	1 unit	
			8	5SY7 108-7	003	5SY7 108-8	004	0.165	1 unit	
			10	5SY7 110-7	003	5SY7 110-8	004	0.165	1 unit	
			13	5SY7 113-7	003	5SY7 113-8	004	0.165	1 unit	
			16	5SY7 116-7	003	5SY7 116-8	004	0.165	1 unit	
			20	5SY7 120-7	003	5SY7 120-8	004	0.165	1 unit	
			25	5SY7 125-7	003	5SY7 125-8	004	0.165	1 unit	
			32 ¹⁾	5SY7 132-7	003	5SY7 132-8	004	0.165	1 unit	
40	5SY7 140-7	003	5SY7 140-8	004	0.165	1 unit				
50	5SY7 150-7	003	5SY7 150-8	004	0.165	1 unit				
63	5SY7 163-7	003	5SY7 163-8	004	0.165	1 unit				
1-pole + N										
		2	0.3	5SY7 514-7	003	5SY7 514-8	004	0.330	1 unit	
			0.5	5SY7 505-7	003	5SY7 505-8	004	0.330	1 unit	
			1	5SY7 501-7	003	5SY7 501-8	004	0.330	1 unit	
			1.6	5SY7 515-7	003	5SY7 515-8	004	0.330	1 unit	
			2	5SY7 502-7	003	5SY7 502-8	004	0.330	1 unit	
			3	5SY7 503-7	003	5SY7 503-8	004	0.330	1 unit	
			4	5SY7 504-7	003	5SY7 504-8	004	0.330	1 unit	
			6	5SY7 506-7	003	5SY7 506-8	004	0.330	1 unit	
			8	5SY7 508-7	003	5SY7 508-8	004	0.330	1 unit	
			10	5SY7 510-7	003	5SY7 510-8	004	0.330	1 unit	
			13	5SY7 513-7	003	5SY7 513-8	004	0.330	1 unit	
			16	5SY7 516-7	003	5SY7 516-8	004	0.330	1 unit	
			20	5SY7 520-7	003	5SY7 520-8	004	0.330	1 unit	
			25	5SY7 525-7	003	5SY7 525-8	004	0.330	1 unit	
			32	5SY7 532-7	003	5SY7 532-8	004	0.330	1 unit	
40	5SY7 540-7	003	5SY7 540-8	004	0.330	1 unit				
50	5SY7 550-7	003	5SY7 550-8	004	0.330	1 unit				
63	5SY7 563-7	003	5SY7 563-8	004	0.330	1 unit				
2-pole										
		2	0.3	5SY7 214-7	003	5SY7 214-8	004	0.330	1 unit	
			0.5	5SY7 205-7	003	5SY7 205-8	004	0.330	1 unit	
			1	5SY7 201-7	003	5SY7 201-8	004	0.330	1 unit	
			1.6	5SY7 215-7	003	5SY7 215-8	004	0.330	1 unit	
			2	5SY7 202-7	003	5SY7 202-8	004	0.330	1 unit	
			3	5SY7 203-7	003	5SY7 203-8	004	0.330	1 unit	
			4	5SY7 204-7	003	5SY7 204-8	004	0.330	1 unit	
			6	5SY7 206-7	003	5SY7 206-8	004	0.330	1 unit	
			8	5SY7 208-7	003	5SY7 208-8	004	0.330	1 unit	
			10	5SY7 210-7	003	5SY7 210-8	004	0.330	1 unit	
			13	5SY7 213-7	003	5SY7 213-8	004	0.330	1 unit	
			16	5SY7 216-7	003	5SY7 216-8	004	0.330	1 unit	
			20	5SY7 220-7	003	5SY7 220-8	004	0.330	1 unit	
			25	5SY7 225-7	003	5SY7 225-8	004	0.330	1 unit	
			32	5SY7 232-7	003	5SY7 232-8	004	0.330	1 unit	
40	5SY7 240-7	003	5SY7 240-8	004	0.330	1 unit				
50	5SY7 250-7	003	5SY7 250-8	004	0.330	1 unit				
63	5SY7 263-7	003	5SY7 263-8	004	0.330	1 unit				







Information and footer to this page and the previous page:

The 5SY7 versions are certified according to UL 1077 and CSA 22.2 No. 235-M 89 and can be installed as "supplementary protectors" up to 277 V AC (1-pole, 1-pole + N) and 480 V AC (2-pole, 3-pole, 3-pole + N, 4-pole).

1) Applies only for 5SY7 132-6 and 5SY7 132-7:
Also suitable for 21 kW active power at a 3-phase current of 400 V (e.g. continuous-flow water heater with short-time operation) and 7 kW active power at 230 V AC (e.g. hot water storage tank in non-continuous operation). For continuous load applications, the use of miniature circuit-breakers of characteristic B or C and $I_n = 40$ A is recommended.

Miniature Circuit-Breakers High-Capacity Product Range

5SY7, 15 kA

	I_n	MW	Characteristic C		PG	Characteristic D		PG	Weight 1 unit approx. kg	PS*/ P. unit Unit(s)
			Order No.	Price 1 unit		Order No.	Price 1 unit			
 <p>3-pole</p> 	A	3								
	0.3		5SY7 314-7		003	5SY7 314-8		004	0.495	1 unit
	0.5		5SY7 305-7		003	5SY7 305-8		004	0.495	1 unit
	1		5SY7 301-7		003	5SY7 301-8		004	0.495	1 unit
	1.6		5SY7 315-7		003	5SY7 315-8		004	0.495	1 unit
	2		5SY7 302-7		003	5SY7 302-8		004	0.495	1 unit
	3		5SY7 303-7		003	5SY7 303-8		004	0.495	1 unit
	4		5SY7 304-7		003	5SY7 304-8		004	0.495	1 unit
	6		5SY7 306-7		003	5SY7 306-8		004	0.495	1 unit
	8		5SY7 308-7		003	5SY7 308-8		004	0.495	1 unit
	10		5SY7 310-7		003	5SY7 310-8		004	0.495	1 unit
	13		5SY7 313-7		003	5SY7 313-8		004	0.495	1 unit
	16		5SY7 316-7		003	5SY7 316-8		004	0.495	1 unit
	20		5SY7 320-7		003	5SY7 320-8		004	0.495	1 unit
	25		5SY7 325-7		003	5SY7 325-8		004	0.495	1 unit
	32 ¹⁾		5SY7 332-7		003	5SY7 332-8		004	0.495	1 unit
40		5SY7 340-7		003	5SY7 340-8		004	0.495	1 unit	
50		5SY7 350-7		003	5SY7 350-8		004	0.495	1 unit	
63		5SY7 363-7		003	5SY7 363-8		004	0.495	1 unit	
 <p>3-pole + N</p> 	A	4								
	0.3		5SY7 614-7		003	5SY7 614-8		004	0.660	1 unit
	0.5		5SY7 605-7		003	5SY7 605-8		004	0.660	1 unit
	1		5SY7 601-7		003	5SY7 601-8		004	0.660	1 unit
	1.6		5SY7 615-7		003	5SY7 615-8		004	0.660	1 unit
	2		5SY7 602-7		003	5SY7 602-8		004	0.660	1 unit
	3		5SY7 603-7		003	5SY7 603-8		004	0.660	1 unit
	4		5SY7 604-7		003	5SY7 604-8		004	0.660	1 unit
	6		5SY7 606-7		003	5SY7 606-8		004	0.660	1 unit
	8		5SY7 608-7		003	5SY7 608-8		004	0.660	1 unit
	10		5SY7 610-7		003	5SY7 610-8		004	0.660	1 unit
	13		5SY7 613-7		003	5SY7 613-8		004	0.660	1 unit
	16		5SY7 616-7		003	5SY7 616-8		004	0.660	1 unit
	20		5SY7 620-7		003	5SY7 620-8		004	0.660	1 unit
	25		5SY7 625-7		003	5SY7 625-8		004	0.660	1 unit
	32		5SY7 632-7		003	5SY7 632-8		004	0.660	1 unit
40		5SY7 640-7		003	5SY7 640-8		004	0.660	1 unit	
50		5SY7 650-7		003	5SY7 650-8		004	0.660	1 unit	
63		5SY7 663-7		003	5SY7 663-8		004	0.660	1 unit	
 <p>4-pole</p> 	A	4								
	0.3		5SY7 414-7		003	5SY7 414-8		004	0.660	1 unit
	0.5		5SY7 405-7		003	5SY7 405-8		004	0.660	1 unit
	1		5SY7 401-7		003	5SY7 401-8		004	0.660	1 unit
	1.6		5SY7 415-7		003	5SY7 415-8		004	0.660	1 unit
	2		5SY7 402-7		003	5SY7 402-8		004	0.660	1 unit
	3		5SY7 403-7		003	5SY7 403-8		004	0.660	1 unit
	4		5SY7 404-7		003	5SY7 404-8		004	0.660	1 unit
	6		5SY7 406-7		003	5SY7 406-8		004	0.660	1 unit
	8		5SY7 408-7		003	5SY7 408-8		004	0.660	1 unit
	10		5SY7 410-7		003	5SY7 410-8		004	0.660	1 unit
	13		5SY7 413-7		003	5SY7 413-8		004	0.660	1 unit
	16		5SY7 416-7		003	5SY7 416-8		004	0.660	1 unit
	20		5SY7 420-7		003	5SY7 420-8		004	0.660	1 unit
	25		5SY7 425-7		003	5SY7 425-8		004	0.660	1 unit
	32		5SY7 432-7		003	5SY7 432-8		004	0.660	1 unit
40		5SY7 440-7		003	5SY7 440-8		004	0.660	1 unit	
50		5SY7 450-7		003	5SY7 450-8		004	0.660	1 unit	
63		5SY7 463-7		003	5SY7 463-8		004	0.660	1 unit	

The 5SY7 versions are certified according to UL 1077 and CSA 22.2 No. 235-M 89 and can be installed as "supplementary protectors" up to 277 V AC (1-pole, 1-pole + N) and 480 V AC (2-pole, 3-pole, 3-pole + N, 4-pole).

1) Applies only for 5SY7 332-7:

Also suitable for 21 kW active power at a 3-phase current of 400 V (e.g. continuous-flow water heater with short-time operation) and 7 kW active power at 230 V AC (e.g. hot water storage tank in non-continuous operation). For continuous load applications, the use of miniature circuit-breakers of characteristic B or C and $I_n = 40$ A is recommended.

* You can order this quantity or a multiple thereof.

Miniature Circuit-Breakers High-Capacity Product Range

5SY8, 25 kA

Application

- U_n : 230/400 V, 50 to 60 Hz, can be used in systems up to 250/440 V AC, 60 V DC per pole
- Standards: EN 60947-2, IEC 60947-2
- Additional components can be retrofitted.







Characteristic C

General line protection, especially advantageous with higher starting currents (lamps, motors, etc.)

Characteristic D

Tripping range adapted to operating equipment involving significant pulse generation (transformers, solenoid valves).

Selection and ordering data







	I_n A	MW	Characteristic C		PG	Characteristic D		PG	Weight 1 unit approx. kg	PS*/ P. unit Unit(s)
			Order No.	Price 1 unit		Order No.	Price 1 unit			
 <p>1-pole</p> 	0.3	1	5SY8 114-7		003	5SY8 114-8		004	0.165	1 unit
	0.5		5SY8 105-7		003	5SY8 105-8		004	0.165	1 unit
	1		5SY8 101-7		003	5SY8 101-8		004	0.165	1 unit
	1.6		5SY8 115-7		003	5SY8 115-8		004	0.165	1 unit
	2		5SY8 102-7		003	5SY8 102-8		004	0.165	1 unit
	3		5SY8 103-7		003	5SY8 103-8		004	0.165	1 unit
	4		5SY8 104-7		003	5SY8 104-8		004	0.165	1 unit
	6		5SY8 106-7		003	5SY8 106-8		004	0.165	1 unit
	8		5SY8 108-7		003	5SY8 108-8		004	0.165	1 unit
	10		5SY8 110-7		003	5SY8 110-8		004	0.165	1 unit
	13		5SY8 113-7		003	5SY8 113-8		004	0.165	1 unit
	16		5SY8 116-7		003	5SY8 116-8		004	0.165	1 unit
	20		5SY8 120-7		003	5SY8 120-8		004	0.165	1 unit
	25		5SY8 125-7		003	5SY8 125-8		004	0.165	1 unit
	32 ¹⁾		5SY8 132-7		003	5SY8 132-8		004	0.165	1 unit
40	5SY8 140-7		003	5SY8 140-8		004	0.165	1 unit		
50	5SY8 150-7		003	5SY8 150-8		004	0.165	1 unit		
63	5SY8 163-7		003	5SY8 163-8		004	0.165	1 unit		
 <p>1-pole + N</p> 	0.3	2	5SY8 514-7		003	5SY8 514-8		004	0.330	1 unit
	0.5		5SY8 505-7		003	5SY8 505-8		004	0.330	1 unit
	1		5SY8 501-7		003	5SY8 501-8		004	0.330	1 unit
	1.6		5SY8 515-7		003	5SY8 515-8		004	0.330	1 unit
	2		5SY8 502-7		003	5SY8 502-8		004	0.330	1 unit
	3		5SY8 503-7		003	5SY8 503-8		004	0.330	1 unit
	4		5SY8 504-7		003	5SY8 504-8		004	0.330	1 unit
	6		5SY8 506-7		003	5SY8 506-8		004	0.330	1 unit
	8		5SY8 508-7		003	5SY8 508-8		004	0.330	1 unit
	10		5SY8 510-7		003	5SY8 510-8		004	0.330	1 unit
	13		5SY8 513-7		003	5SY8 513-8		004	0.330	1 unit
	16		5SY8 516-7		003	5SY8 516-8		004	0.330	1 unit
	20		5SY8 520-7		003	5SY8 520-8		004	0.330	1 unit
	25		5SY8 525-7		003	5SY8 525-8		004	0.330	1 unit
	32		5SY8 532-7		003	5SY8 532-8		004	0.330	1 unit
40	5SY8 540-7		003	5SY8 540-8		004	0.330	1 unit		
50	5SY8 550-7		003	5SY8 550-8		004	0.330	1 unit		
63	5SY8 563-7		003	5SY8 563-8		004	0.330	1 unit		
 <p>2-pole</p> 	0.3	2	5SY8 214-7		003	5SY8 214-8		004	0.330	1 unit
	0.5		5SY8 205-7		003	5SY8 205-8		004	0.330	1 unit
	1		5SY8 201-7		003	5SY8 201-8		004	0.330	1 unit
	1.6		5SY8 215-7		003	5SY8 215-8		004	0.330	1 unit
	2		5SY8 202-7		003	5SY8 202-8		004	0.330	1 unit
	3		5SY8 203-7		003	5SY8 203-8		004	0.330	1 unit
	4		5SY8 204-7		003	5SY8 204-8		004	0.330	1 unit
	6		5SY8 206-7		003	5SY8 206-8		004	0.330	1 unit
	8		5SY8 208-7		003	5SY8 208-8		004	0.330	1 unit
	10		5SY8 210-7		003	5SY8 210-8		004	0.330	1 unit
	13		5SY8 213-7		003	5SY8 213-8		004	0.330	1 unit
	16		5SY8 216-7		003	5SY8 216-8		004	0.330	1 unit
	20		5SY8 220-7		003	5SY8 220-8		004	0.330	1 unit
	25		5SY8 225-7		003	5SY8 225-8		004	0.330	1 unit
	32		5SY8 232-7		003	5SY8 232-8		004	0.330	1 unit
40	5SY8 240-7		003	5SY8 240-8		004	0.330	1 unit		
50	5SY8 250-7		003	5SY8 250-8		004	0.330	1 unit		
63	5SY8 263-7		003	5SY8 263-8		004	0.330	1 unit		

1) Applies only for 5SY8 132-7.

Also suitable for 21 kW active power at a 3-phase current of 400 V (e.g. continuous-flow water heater with short-time operation) and 7 kW active power at 230 V AC (e.g. hot water storage tank in non-continuous operation). For continuous load applications, the use of miniature circuit-breakers of characteristic C and $I_n = 40$ A is recommended.

Miniature Circuit-Breakers High-Capacity Product Range

5SY8, 25 kA

	I_n A	MW	Characteristic C		PG	Characteristic D		PG	Weight 1 unit approx. kg	PS*/ P. unit Unit(s)
			Order No.	Price 1 unit		Order No.	Price 1 unit			
 <p>3-pole</p> 	0.3	3	5SY8 314-7		003	5SY8 314-8		004	0.495	1 unit
	0.5		5SY8 305-7		003	5SY8 305-8		004	0.495	1 unit
	1		5SY8 301-7		003	5SY8 301-8		004	0.495	1 unit
	1.6		5SY8 315-7		003	5SY8 315-8		004	0.495	1 unit
	2		5SY8 302-7		003	5SY8 302-8		004	0.495	1 unit
	3		5SY8 303-7		003	5SY8 303-8		004	0.495	1 unit
	4		5SY8 304-7		003	5SY8 304-8		004	0.495	1 unit
	6		5SY8 306-7		003	5SY8 306-8		004	0.495	1 unit
	8		5SY8 308-7		003	5SY8 308-8		004	0.495	1 unit
	10		5SY8 310-7		003	5SY8 310-8		004	0.495	1 unit
	13		5SY8 313-7		003	5SY8 313-8		004	0.495	1 unit
	16		5SY8 316-7		003	5SY8 316-8		004	0.495	1 unit
	20		5SY8 320-7		003	5SY8 320-8		004	0.495	1 unit
	25		5SY8 325-7		003	5SY8 325-8		004	0.495	1 unit
	32 ¹⁾		5SY8 332-7		003	5SY8 332-8		004	0.495	1 unit
	40		5SY8 340-7		003	5SY8 340-8		004	0.495	1 unit
50	5SY8 350-7		003	5SY8 350-8		004	0.495	1 unit		
63	5SY8 363-7		003	5SY8 363-8		004	0.495	1 unit		
 <p>3-pole + N</p> 	0.3	4	5SY8 614-7		003	5SY8 614-8		004	0.660	1 unit
	0.5		5SY8 605-7		003	5SY8 605-8		004	0.660	1 unit
	1		5SY8 601-7		003	5SY8 601-8		004	0.660	1 unit
	1.6		5SY8 615-7		003	5SY8 615-8		004	0.660	1 unit
	2		5SY8 602-7		003	5SY8 602-8		004	0.660	1 unit
	3		5SY8 603-7		003	5SY8 603-8		004	0.660	1 unit
	4		5SY8 604-7		003	5SY8 604-8		004	0.660	1 unit
	6		5SY8 606-7		003	5SY8 606-8		004	0.660	1 unit
	8		5SY8 608-7		003	5SY8 608-8		004	0.660	1 unit
	10		5SY8 610-7		003	5SY8 610-8		004	0.660	1 unit
	13		5SY8 613-7		003	5SY8 613-8		004	0.660	1 unit
	16		5SY8 616-7		003	5SY8 616-8		004	0.660	1 unit
	20		5SY8 620-7		003	5SY8 620-8		004	0.660	1 unit
	25		5SY8 625-7		003	5SY8 625-8		004	0.660	1 unit
	32		5SY8 632-7		003	5SY8 632-8		004	0.660	1 unit
	40		5SY8 640-7		003	5SY8 640-8		004	0.660	1 unit
50	5SY8 650-7		003	5SY8 650-8		004	0.660	1 unit		
63	5SY8 663-7		003	5SY8 663-8		004	0.660	1 unit		
 <p>4-pole</p> 	0.3	4	5SY8 414-7		003	5SY8 414-8		004	0.660	1 unit
	0.5		5SY8 405-7		003	5SY8 405-8		004	0.660	1 unit
	1		5SY8 401-7		003	5SY8 401-8		004	0.660	1 unit
	1.6		5SY8 415-7		003	5SY8 415-8		004	0.660	1 unit
	2		5SY8 402-7		003	5SY8 402-8		004	0.660	1 unit
	3		5SY8 403-7		003	5SY8 403-8		004	0.660	1 unit
	4		5SY8 404-7		003	5SY8 404-8		004	0.660	1 unit
	6		5SY8 406-7		003	5SY8 406-8		004	0.660	1 unit
	8		5SY8 408-7		003	5SY8 408-8		004	0.660	1 unit
	10		5SY8 410-7		003	5SY8 410-8		004	0.660	1 unit
	13		5SY8 413-7		003	5SY8 413-8		004	0.660	1 unit
	16		5SY8 416-7		003	5SY8 416-8		004	0.660	1 unit
	20		5SY8 420-7		003	5SY8 420-8		004	0.660	1 unit
	25		5SY8 425-7		003	5SY8 425-8		004	0.660	1 unit
	32		5SY8 432-7		003	5SY8 432-8		004	0.660	1 unit
	40		5SY8 440-7		003	5SY8 440-8		004	0.660	1 unit
50	5SY8 450-7		003	5SY8 450-8		004	0.660	1 unit		
63	5SY8 463-7		003	5SY8 463-8		004	0.660	1 unit		

1) Applies only for 5SY8 332-7.

Also suitable for 21 kW active power at a 3-phase current of 400 V (e.g. continuous-flow water heater with short-time operation) and 7 kW active power at 230 V AC (e.g. hot water storage tank in non-continuous operation). For continuous load applications, the use of miniature circuit-breakers of characteristic C and $I_n = 40$ A is recommended.

* You can order this quantity or a multiple thereof.

Siemens LV 1 · 2006

19/69

Miniature Circuit-Breakers AC/DC Product Range

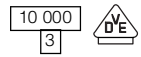





5SY5, 10 kA

Application

- U_n : 230/400 V, 50 to 60 Hz, 220 V DC per pole, applicable in systems up to 250/440 V AC
 - 220 V DC: 1-pole
 - 440 V DC: 2-pole

- Standards: EN 60898, DIN VDE 0641 Part 11, IEC 60898
- Additional components can be retrofitted.

Selection and ordering data

	I_n	MW	Characteristic B		PG	Characteristic C		Weight 1 unit approx.	PS*/ P. unit
			Order No.	Price 1 unit		Order No.	Price 1 unit		
	A							kg	Unit(s)
 <p>1-pole</p> 	0.3	1	--			5SY5 114-7	003	0.165	1 unit
	0.5		--			5SY5 105-7	003	0.165	1 unit
	1		--			5SY5 101-7	003	0.147	1 unit
	1.6		--			5SY5 115-7	003	0.165	1 unit
	2		5SY5 102-6		002	5SY5 102-7	003	0.165	1 unit
	3		--			5SY5 103-7	003	0.165	1 unit
	4		5SY5 104-6		002	5SY5 104-7	003	0.165	1 unit
	6		5SY5 106-6		002	5SY5 106-7	003	0.165	1 unit
	8		--			5SY5 108-7	003	0.165	1 unit
	10		5SY5 110-6		002	5SY5 110-7	003	0.165	1 unit
	13		5SY5 113-6		002	5SY5 113-7	003	0.165	1 unit
	16		5SY5 116-6		002	5SY5 116-7	003	0.165	1 unit
	20		5SY5 120-6		002	5SY5 120-7	003	0.165	1 unit
	25		5SY5 125-6		002	5SY5 125-7	003	0.165	1 unit
	32 ¹⁾		5SY5 132-6		002	5SY5 132-7	003	0.165	1 unit
	40		5SY5 140-6		002	5SY5 140-7	003	0.165	1 unit
50		5SY5 150-6		002	5SY5 150-7	003	0.165	1 unit	
63		5SY5 163-6		002	5SY5 163-7	003	0.165	1 unit	
 <p>2-pole</p> 	0.3	2	--			5SY5 214-7	003	0.330	1 unit
	0.5		--			5SY5 205-7	003	0.330	1 unit
	1		--			5SY5 201-7	003	0.330	1 unit
	1.6		--			5SY5 215-7	003	0.330	1 unit
	2		--			5SY5 202-7	003	0.330	1 unit
	3		--			5SY5 203-7	003	0.330	1 unit
	4		--			5SY5 204-7	003	0.330	1 unit
	6		5SY5 206-6		002	5SY5 206-7	003	0.330	1 unit
	8		--			5SY5 208-7	003	0.330	1 unit
	10		5SY5 210-6		002	5SY5 210-7	003	0.330	1 unit
	13		5SY5 213-6		002	5SY5 213-7	003	0.330	1 unit
	16		5SY5 216-6		002	5SY5 216-7	003	0.330	1 unit
	20		5SY5 220-6		002	5SY5 220-7	003	0.330	1 unit
	25		5SY5 225-6		002	5SY5 225-7	003	0.330	1 unit
	32		5SY5 232-6		002	5SY5 232-7	003	0.330	1 unit
	40		5SY5 240-6		002	5SY5 240-7	003	0.330	1 unit
50		5SY5 250-6		002	5SY5 250-7	003	0.330	1 unit	
63		5SY5 263-6		002	5SY5 263-7	003	0.330	1 unit	

The terminal section indicates the DC polarity value which must essentially be observed during connection.

1) Also suitable for 21 kW active power at a 3-phase current of 400 V (e.g. continuous-flow water heater with short-time operation) and 7 kW active power at 230 V AC (e.g. hot water storage tank in non-continuous operation). For continuous load applications, we recommend using 5SY...-6/-7 miniature circuit-breakers with $I_n = 40$ A.









Miniature Circuit-Breakers High-Current Product Range

5SP4, 10 kA

Application

- U_n : 230/400 V, 50 to 60 Hz, can be used in systems up to 250/440 V AC, 60 V DC per pole
- Standards: EN 60898, IEC 60898, DIN VDE 0641 Part 11, EN 60204
- Additional components can be retrofitted individually.
- Main switch characteristics according to EN 60204
- Can be snapped onto standard mounting rail according to EN 60715
- Can be screwed onto base
- As main control and miniature circuit-breaker in non-residential and industrial buildings.

Selection and ordering data

	I_n A	MW	Characteristic B		PG	Characteristic C		PG	Characteristic D		PG	Weight 1 unit approx. kg	PS*/ P. unit Unit(s)
			Order No.	Price 1 unit		Order No.	Price 1 unit		Order No.	Price 1 unit			
 1-pole 	80 100 125	1.5	5SP4 180-6	002	002	5SP4 180-7	003	003	5SP4 180-8	004	004	0.258	1 unit
			5SP4 191-6	002		5SP4 191-7	003		5SP4 191-8	004		0.258	1 unit
			5SP4 192-6	002		5SP4 192-7	003		--	--		0.258	1 unit
 2-pole 	80 100 125	3	5SP4 280-6	002	002	5SP4 280-7	003	003	5SP4 280-8	004	004	0.516	1 unit
			5SP4 291-6	002		5SP4 291-7	003		5SP4 291-8	004		0.516	1 unit
			5SP4 292-6	002		5SP4 292-7	003		--	--		0.516	1 unit
 3-pole 	80 100 125	4.5	5SP4 380-6	002	002	5SP4 380-7	003	003	5SP4 380-8	004	004	0.762	1 unit
			5SP4 391-6	002		5SP4 391-7	003		5SP4 391-8	004		0.762	1 unit
			5SP4 392-6	002		5SP4 392-7	003		--	--		0.762	1 unit
 4-pole 	80 100 125	6	5SP4 480-6	002	002	5SP4 480-7	003	003	5SP4 480-8	004	004	1.032	1 unit
			5SP4 491-6	002		5SP4 491-7	003		5SP4 491-8	004		1.032	1 unit
			5SP4 492-6	002		5SP4 492-7	003		--	--		1.032	1 unit

* You can order this quantity or a multiple thereof.

Miniature Circuit-Breakers Supplementary Components

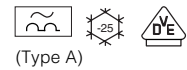

RC units for 5SY.

Benefits



- High flexibility in use
- Customer-end combination of characteristics from RC unit and circuit-breaker version
- In conjunction with a miniature circuit-breaker the combined protection of personnel and lines is possible

Application

- Personnel and fire protection
 - $I_{\Delta n} \leq 30$ mA: additional protection in the case of direct contact
 - $I_{\Delta n} \leq 300$ mA: preventative fire protection in the case of ground fault currents

- Product standards: IEC/EN 61009-1 (VDE 0664, Part 20); IEC/EN 61009-2-1 (VDE 0664, Part 21); IEC/EN 61543 (VDE 0664, Part 30)
- Rated voltage for 2, 3 and 4-pole version: 230 to 400 V AC; 50 to 60 Hz; applicable in systems up to: 250/440 V AC
- Can be combined with miniature circuit-breakers of characteristic A, B, C and D
- Definition of surge current withstand capability with current waveform 8/20 μ s according to DIN VDE 0432, Part 2
- **S** S type: can be used as upstream group switch for selective tripping contrary to a downstream standard RCCB. Very high surge current withstand capability: > 5 kA
- **K** K type: short-time delayed tripping in the case of transient leakage currents. High surge current withstand capability: > 3 kA.

Selection and ordering data

	Rated fault current $I_{\Delta n}$ mA	Rated current I_n A	MW	Ver- sion	Order No.	Price 1 unit	PG	Weight 1 unit approx. kg	PS*/ P. unit Unit(s)
Instantaneous tripping, surge current withstand capability > 1 kA¹⁾									
	2-pole								
		10	0.3 ... 16	2	5SM2 121-6		007	0.180	1 unit
		30	0.3 ... 40	2	5SM2 322-6		007	0.170	1 unit
		300			5SM2 622-6		007	0.170	1 unit
		30	0.3 ... 63		5SM2 325-6		007	0.170	1 unit
	300			5SM2 625-6		007	0.170	1 unit	
	500			5SM2 725-6		007	0.350	1 unit	
	3-pole								
		30	0.3 ... 40	3	5SM2 332-6		007	0.260	1 unit
		300			5SM2 632-6		007	0.260	1 unit
		30	0.3 ... 63		5SM2 335-6		007	0.260	1 unit
		300			5SM2 635-6		007	0.260	1 unit
	500			5SM2 735-6		007	0.260	1 unit	
	4-pole								
		30	0.3 ... 40	3	5SM2 342-6		007	0.290	1 unit
		300			5SM2 642-6		007	0.290	1 unit
		30	0.3 ... 63		5SM2 345-6		007	0.290	1 unit
		300			5SM2 645-6		007	0.290	1 unit
	500			5SM2 745-6		007	0.290	1 unit	
K Short-time delayed, surge current withstand capability > 3 kA¹⁾									
4-pole		30	0.3 ... 40	3	K		007	0.350	1 unit
			0.3 ... 63		K		007	0.350	1 unit
S Selective, surge current withstand capability > 5 kA¹⁾									
2-pole		300	0.3 ... 40	2	S		007	0.170	1 unit
		300	0.3 ... 63		S		007	0.170	1 unit
3-pole		300	0.3 ... 63	3	S		007	0.260	1 unit
		500			S		007	0.260	1 unit
		1 000			S		007	0.260	1 unit
4-pole		300	0.3 ... 63	3	S		007	0.290	1 unit
		500			S		007	0.290	1 unit
		1 000			S		007	0.290	1 unit

1) Not for 5SY6 ...-KV and 5SY5.

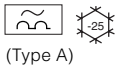

Miniature Circuit-Breakers Supplementary Components

RC units for 5SP4

Benefits



- High flexibility in use
- Customer-end combination of characteristics from RC unit and circuit-breaker version
- In conjunction with a miniature circuit-breaker the combined protection of personnel and lines is possible
- External remote tripping with terminals Y1/Y2.

Application

- Personnel and fire protection
 - $I_{\Delta n} \leq 30$ mA: Additional protection in the case of direct contact
 - $I_{\Delta n} \leq 300$ mA: Preventative fire protection in the case of ground fault currents

- Product standards: IEC/EN 61009-1 (VDE 0664, Part 20); IEC/EN 61009-2-1 (VDE 0664, Part 21); IEC/EN 61543 (VDE 0664, Part 30)
- Rated voltage
 - 2-pole: 125 to 230 V AC; 50 to 60 Hz; can be used in systems up to 125/240 V AC
 - 4-pole: 230 to 400 V AC; 50 to 60 Hz; can be used in systems up to 230/400 V AC
- Can be combined with miniature circuit-breakers of characteristic B and C
- Definition of surge current withstand capability with current waveform 8/20 μ s according to DIN VDE 0432, Part 2
- **S** S type: Can be used as upstream group switch for selective tripping contrary to a downstream standard RCCB. Very high surge current withstand capability: > 5 kA.

Selection and ordering data

	Rated residual current $I_{\Delta n}$ mA	Rated current I_n A	MW	Ver- sion	Order No.	Price 1 unit	PG	Weight 1 unit approx. kg	PS*/ P. unit Unit(s)
Instantaneous tripping, surge current withstand capability > 1 kA									
	30 300	80 ... 100	3.5		5SM2 327-6		007	0.410	1 unit
					5SM2 627-6		007	0.410	1 unit
	30 300	80 ... 100	5		5SM2 347-6		007	0.630	1 unit
					5SM2 647-6		007	0.630	1 unit
S Selective, surge current withstand capability > 5 kA									
2-pole	300	80 ... 100		S	5SM2 627-8		007	0.410	1 unit
4-pole	300	80 ... 100		S	5SM2 647-8		007	0.630	1 unit
	1 000				5SM2 847-8		007	0.630	1 unit

* You can order this quantity or a multiple thereof.

Miniature Circuit-Breakers Supplementary Components

Auxiliary switches/fault signal contacts for 5SY. and 5SP4

Benefits

- Can be retrofitted individually (for mounting concept, see page 19/75)
- Mounting with factory-fitted brackets
- Short-circuit protection with miniature circuit-breakers of characteristic B or C and $I_n = 6\text{ A}$ or gL 6 A fuses.
- Broad range of applications thanks to the additional version for controlling programmable controllers (PLC) according to EN 61131-2
- Connectable to *instabus* KNX *EIB* and AS-Interface bus through binary inputs.

Application

- Indication of the miniature circuit-breaker's switching state
 - AS: ON/OFF
 - FC: Tripped.

Design

Auxiliary switches (AS)

5ST3 013
5ST3 014
5ST3 015









- Range of application 1 mA/5 V DC up to 50 mA/30 V DC.

Auxiliary switches (AS) and fault signal contacts (FC)

5ST3 0.0
5ST3 0.1
5ST3 0.2

- Min. contact load:
50 mA, 24 V
- Max. contact load:
NO contacts:
2 A, 400 V AC, AC-14
6 A, 230 V AC, AC-14
1 A, 220 V DC, DC-13
1 A, 110 V DC, DC-13
3 A, 60 V DC, DC-13
6 A, 24 V DC, DC-13
NC contacts:
2 A, 400 V AC, AC-13
6 A, 230 V AC, AC-13
1 A, 220 V DC, DC-13
1 A, 110 V DC, DC-13
3 A, 60 V DC, DC-13
6 A, 24 V DC, DC-13

Selection and ordering data

	Version	MW	Order No.	Price 1 unit	PG	Weight 1 unit approx. kg	PS*/ P. unit Unit(s)	
	Auxiliary switches (AS) for 5SY miniature circuit-breakers¹⁾							
		For small output	1 NO + 1 NC	0.5	5ST3 010 5ST3 013	027 027	0.050 0.050	1 unit 1 unit
		For small output	2 NO		5ST3 011 5ST3 014	027 027	0.050 0.050	1 unit 1 unit
		For small output	2 NC		5ST3 012 5ST3 015	027 027	0.050 0.050	1 unit 1 unit
		Fault signal contacts (FC) for 5SY miniature circuit-breakers¹⁾						
				1 NO + 1 NC	0.5	5ST3 020	027	0.050
			2 NO		5ST3 021	027	0.050	1 unit
			2 NC		5ST3 022	027	0.050	1 unit

1) Not for 5SY6 ...-KV.

Miniature Circuit-Breakers Supplementary Components

Remote controlled operating mechanisms for 5SY and 5SP4

Benefits

- Can be retrofitted individually (for mounting concept, see below)
- Mounting with factory-fitted brackets
- Can be mechanically latched and locked
- Further additional components can be attached
- Function switch on the front
- Connectable to *instabus* KNX EIB and AS-Interface bus through binary inputs and outputs
- $U_N = 230 \text{ V}$, 50 to 60 Hz

Mounting concept

Using this mounting concept, all additional 5ST3 components can be combined with miniature circuit-breakers of the 5SY¹⁾ and 5SP4 series:

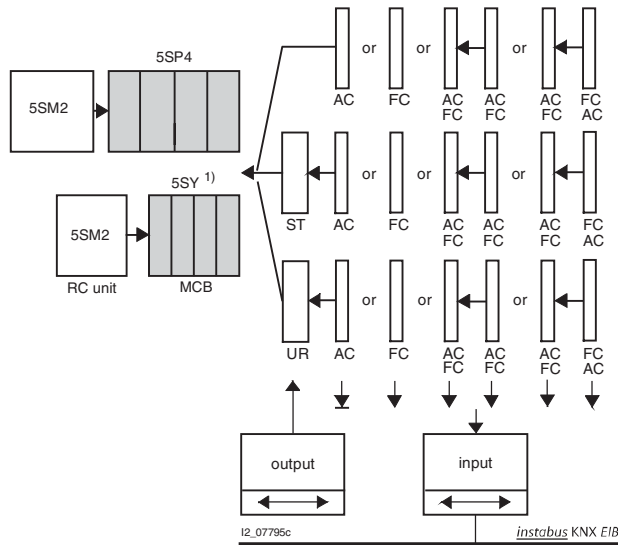

1) 5SY6: only AC and FC; 5SY5: no RC unit

Function

- ON/OFF remote control switching of miniature circuit-breaker and ON remote control switching of RC unit
- Remote ON switching possible following acknowledgment of fault occurrence
- Manual switching on-site possible
- Remote display of switching status of remote controlled operating mechanism and miniature circuit-breaker

Selection and ordering data

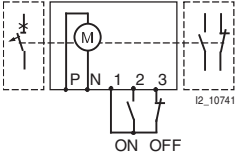
	Rated voltage U_n	MW	Order No.	Price 1 unit	PG	Weight 1 unit approx.	PS*/ P. unit
	V AC					kg	Unit(s)
 <p>Remote-controlled operating mechanisms for 5SY1¹⁾ and 5SP4 miniature circuit-breakers</p> 	230	3.5	5ST3 050		027	0.395	1 unit

For detailed application information, see Operator's Guide.

1) Not for 5SY6...-KV.

* You can order this quantity or a multiple thereof.

Siemens LV 1 · 2006

19/75

Miniature Circuit-Breakers Supplementary Components

Shunt trips/undervoltage releases for 5SY and 5SP4

Benefits

Shunt trips

- Can be retrofitted individually (for mounting concept, see page 19/75)
- Response limits according to DIN VDE 0660 Part 100, 7.2.1.4
- For voltages:
110 to 415 V AC, 110 V DC
24 to 48 V AC/DC
- Can be connected to *instabus* KNX *EIB* and AS-Interface bus through binary outputs.

Undervoltage trip units

- Can be retrofitted individually (for mounting concept, see page 19/75)
- Response limits according to DIN VDE 0660 Part 100, 7.2.1.3
- For voltages:
230 V AC
110 V DC
24 V DC
- Can be connected to *instabus* KNX *EIB* and AS-Interface bus through binary outputs.

Application



Shunt trips

- Remote tripping of the miniature circuit-breaker.

Undervoltage trip units

- Can be used as remote trip in an EMERGENCY-STOP loop
- Ensures disconnection of the control circuit according to EN 60204
- In cases of interrupted or insufficient voltage, the undervoltage release trips the miniature circuit-breaker or prevents it from switching on.

Selection and ordering data

	Rated voltage U_n	MW	Order No.	Price 1 unit	PG	Weight 1 unit approx. kg	PS*/ P. unit Unit(s)	
	Shunt trips (ST) for 5SY4, 5SY6, 5SY7, 5SY8, 5SY5, 5SP4¹⁾ miniature circuit-breakers							
		110 ... 415 V AC 24 ... 48 V AC/DC	1 1	5ST3 030 5ST3 031		027 027	0.098 0.098	1 unit 1 unit
	Undervoltage releases (UR) for 5SY4, 5SY6, 5SY7, 5SY8, 5SY5, 5SP4¹⁾ miniature circuit-breakers							
		230 V AC 110 V DC 24 V DC	1	5ST3 040 5ST3 041 5ST3 042		027 027 027	0.115 0.115 0.115	1 unit 1 unit 1 unit
		230 V AC 110 V DC 24 V DC	1	5ST3 043 5ST3 044 5ST3 045		027 027 027	0.115 0.115 0.115	1 unit 1 unit 1 unit

1) Not for 5SY6 ...-KV.

Miniature Circuit-Breakers Accessories

For 5SJ6, 5SY, and 5SP4

Application

5ST3 7 busbar systems

- According to DIN 57606 and DIN 57659
- Load at infeed single-sided/in center
 - 50 A/90 A for 10 mm²
 - 65 A/120 A for 16 mm²
- Pin-type connections
- 1-phase and multi-phase
- Cu 10 mm², 16 mm² fully insulated
- Lug spacing: 18 mm
- No additional connection terminal required for stranded connections up to 35 mm²
- Excellent accessibility of the feeder cables



5ST3 6 busbar systems

- According to IEC 60664, 500 V (40 °C), fully insulated
- Load at infeed single-sided/in center
 - 50 A/90 A for 10 mm²
 - 65 A/120 A for 16 mm².

Application

- Pin-type connections
- Any length possible due to combination of 3 fixed busbar lengths
- Favorable current and temperature conduction due to overlapping of individual components
- No further need for time-consuming and tedious tasks, such as cutting, cutting to length, deburring, cleaning of cut surfaces and mounting of end caps
- Reliable touch protection for non-assigned connections

Selection and ordering data

	Length	Order No.	Price 1 unit	PG	Weight 1 unit approx.	PS*/ P. unit
	mm				kg	Unit(s)
5ST3 7 busbar systems for 5SJ6, 5SY6, 5SY4, 5SY7, 5SY8, 5SY5 miniature circuit-breakers						
	Busbars 10 mm²					
	Fully insulated					
	1-phase	214	5ST3 730		0.040	1 unit
	1-phase + AS		5ST3 732	027	0.040	1 unit
	2-phase		5ST3 734	027	0.060	1 unit
	2-phase + AS		5ST3 736	027	0.060	1 unit
	3-phase		5ST3 738	027	0.100	1 unit
	3-phase + AS		5ST3 741	027	0.100	1 unit
	3 × (1-phase + AS)		5ST3 743	027	0.100	1 unit
	4-phase		5ST3 745	027	0.150	1 unit
	3-phase, for a 5SM3 4-pole RCCB with 8 miniature circuit-breakers					
	3/N + 8 connections		5ST3 747		0.150	1 unit
	Without end caps					
	1-phase	1016	5ST3 731		0.190	1 unit
	1-phase + AS		5ST3 733	027	0.190	1 unit
	2-phase		5ST3 735	027	0.290	1 unit
	2-phase + AS		5ST3 737	027	0.290	1 unit
3-phase		5ST3 740	027	0.430	1 unit	
3-phase + AS		5ST3 742	027	0.430	1 unit	
3 × (1-phase + AS)		5ST3 744	027	0.430	1 unit	
4-phase		5ST3 746	027	0.700	1 unit	
	Busbars 16 mm²					
	Fully insulated					
	1-phase	214	5ST3 700		0.040	1 unit
	1-phase + AS		5ST3 702	027	0.040	1 unit
	2-phase		5ST3 704	027	0.060	1 unit
	2-phase + AS		5ST3 706	027	0.060	1 unit
	3-phase		5ST3 708	027	0.100	1 unit
	3-phase + AS		5ST3 711	027	0.100	1 unit
	3 × (1-phase + AS)		5ST3 713	027	0.100	1 unit
	4-phase		5ST3 715	027	0.150	1 unit
	3-phase, for a 5SM3 4-pole RCCB with 8 miniature circuit-breakers					
	3/N + 8 connections		5ST3 717		0.150	1 unit
	Without end caps					
	1-phase	1016	5ST3 701		0.190	1 unit
	1-phase + AS		5ST3 703	027	0.190	1 unit
	2-phase		5ST3 705	027	0.290	1 unit
	2-phase + AS		5ST3 707	027	0.290	1 unit
3-phase		5ST3 710	027	0.430	1 unit	
3-phase + AS		5ST3 712	027	0.430	1 unit	
3 × (1-phase + AS)		5ST3 714	027	0.430	1 unit	
4-phase		5ST3 716	027	0.700	1 unit	

AS: auxiliary circuit switch





* You can order this quantity or a multiple thereof.

Siemens LV 1 - 2006

19/77

Miniature Circuit-Breakers Accessories

For 5SJ6, 5SY. and 5SP4

	Order No.	Price 1 unit	PG	Weight 1 unit approx. kg	PS*/ P. unit Unit(s)
5ST3 7 busbar systems for 5SJ6, 5SY6, 5SY4, 5SY7, 5SY8, 5SY5 miniature circuit-breakers					
	End caps For lateral insulation of cut-to-length busbars				
	1-phase	5ST3 748	027	0.001	1 unit
	2 and 3-phase	5ST3 750	027	0.001	1 unit
	4-phase	5ST3 718	027	0.001	10 units
5ST3 6 busbar systems for 5SJ6, 5SY6, 5SY4, 5SY7, 5SY8, 5SY5 miniature circuit-breakers					
	Busbars 10 mm² Fully insulated				
5ST3 613	1-phase				
	2 x 1-phase	5ST3 600	027	0.005	1 unit
	6 x 1-phase	5ST3 601	027	0.018	1 unit
	12 x 1-phase	5ST3 602	027	0.036	1 unit
	2 x (1-phase + AS/FC)	5ST3 603	027	0.008	1 unit
5ST3 614	6 x (1-phase + AS/FC)	5ST3 604	027	0.024	1 unit
	9 x (1-phase + AS/FC)	5ST3 605	027	0.036	1 unit
	2-phase				
	2 x 2-phase	5ST3 606	027	0.016	1 unit
	3 x 2-phase	5ST3 607	027	0.024	1 unit
	6 x 2-phase	5ST3 608	027	0.048	1 unit
5ST3 615	2 x (2-phase + AS/FC)	5ST3 610	027	0.020	1 unit
	3 x (2-phase + AS/FC)	5ST3 611	027	0.030	1 unit
	5 x (2-phase + AS/FC)	5ST3 612	027	0.050	1 unit
	3-phase				
	2 x 3-phase	5ST3 613	027	0.039	1 unit
	3 x 3-phase	5ST3 614	027	0.060	1 unit
	4 x 3-phase	5ST3 615	027	0.076	1 unit
	2 x (3-phase + AS/FC)	5ST3 616	027	0.040	1 unit
	4 x (3-phase + AS/FC)	5ST3 617	027	0.080	1 unit
	2 x (3 x (1-phase) + AS/FC) ¹⁾	5ST3 618	027	0.044	1 unit
	3 x (3 x (1-phase) + AS/FC) ¹⁾	5ST3 620	027	0.066	1 unit
	4-phase				
	2 x 4-phase	5ST3 621	027	0.051	1 unit
	3 x 4-phase	5ST3 622	027	0.078	1 unit
	2 x 3 x (1-phase + N) ²⁾	5ST3 623	027	0.078	1 unit
	3-phase, for a 5SM3 4-pole RCCB with 8 miniature circuit-breakers				
	3/N + 8 connections	5ST3 624	027	0.075	1 unit
	Touch protection For free connections, yellow (RAL 1004)	5ST3 655	027	0.003	1 unit
	Assortments			1 set	
	20 x 5ST3 613 + 10 x 5ST3 614 + 50 x 5ST3 615 + 50 x 5ST3 655	5ST3 656	027	5.330	1 set



AS: auxiliary circuit switch
FC: fault signal switch

1) 3 x (1-phase + AS/FC) ≅ 3 x (L 1 + AS/FC, L 2 + AS/FC, L 3 + AS/FC).

2) 3 x (1-phase + N) ≅ 3 x (L 1 + N, L 2 + N, L 3 + N).

Miniature Circuit-Breakers Accessories

For 5SJ6, 5SY, and 5SP4

	Order No.	Price 1 unit	PG	Weight 1 unit approx. kg	PS*/ P. unit Unit(s)
5ST3 6 busbar systems for 5SJ6, 5SY6, 5SY4, 5SY7, 5SY8, 5SY5 miniature circuit-breakers					
Busbars 16 mm²					
Fully insulated					
 5ST3 643	1-phase				
	2 x 1-phase				
	6 x 1-phase				
 5ST3 644	12 x 1-phase				
	2 x (1-phase + AS/FC)				
	6 x (1-phase + AS/FC)				
 5ST3 645	9 x (1-phase + AS/FC)				
	2-phase				
	2 x 2-phase				
	3 x 2-phase				
	6 x 2-phase				
	2 x (2-phase + AS/FC)				
	3 x (2-phase + AS/FC)				
	5 x (2-phase + AS/FC)				
	3-phase				
	2 x 3-phase				
	3 x 3-phase				
	4 x 3-phase				
2 x (3-phase + AS/FC)					
4 x (3-phase + AS/FC)					
2 x (3 x (1-phase) + AS/FC) ¹⁾					
3 x (3 x (1-phase) + AS/FC) ¹⁾					
4-phase					
2 x 4-phase					
3 x 4-phase					
2 x 3 x (1-phase + N) ²⁾					
3-phase, for a 5SM3 4-pole RCCB with 8 miniature circuit-breakers					
3/N + 8 connections					
Touch protection					
For free connections, yellow (RAL 1004)					
Assortments					
20 x 5ST3 643 + 10 x 5ST3 644 + 50 x 5ST3 645 + 50 x 5ST3 655					

AS: auxiliary circuit switch
FC: fault signal switch

1) 3 x (1-phase + AS/FC) ≙ 3 x (L 1 + AS/FC, L 2 + AS/FC, L 3 + AS/FC).
2) 3 x (1-phase + N) ≙ 3 x (L 1 + N, L 2 + N, L 3 + N).







* You can order this quantity or a multiple thereof.

Siemens LV 1 - 2006

19/79

Miniature Circuit-Breakers Accessories

For 5SJ6, 5SY, and 5SP4

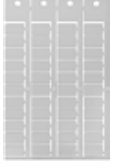
MW	Order No.	Price 1 unit	PG	Weight 1 unit approx. kg	PS*/ P. unit Unit(s)
Accessories for 5SJ6, 5SY6, 5SY4, 5SY7, 5SY8, 5SY5, 5SP4 miniature circuit-breakers					
	Terminal covers Can be used with all types of poles For additional covering of screw openings Prevents removal of the device from the standard mounting rail Sealable	5ST3 800	027	0.001	5 units
	Handle locking devices Can be used with all types of poles Prevents unintended on and off switching Sealable Padlock with a shackle of max. 3 mm	5ST3 801	027	0.008	1 unit
	Padlocks For 5ST3 801 handle locking device	5ST3 802	027	0.027	1 unit
	Locking devices Consisting of 5ST3 801 handle locking device and 5ST3 802 padlock	5ST3 803	027	0.035	1 set
	Spacers Contour for modular devices with a mounting depth of 70 mm Can be snapped onto either side of the busbar so that two spacers allow for convenient cable routing	5TG8 240	027	0.010	2 units
		0.5			
	Snap-on terminals For 35 mm standard mounting rail For conductors up to 16 mm ² solid or conductors up to 10 mm ² stranded Width: 0.5 MW	5ST2 112	027	0.008	1 unit
	Fixing parts 1 MW (sheet metal) 4 MW (plastic)	5ST2 121 5ST2 201	027 027	0.017 0.012	1 unit 1 unit
	Labeling plates (white) 15 mm x 9 mm, 3 frames containing 44 plates each Attachable to the lower casing collar • Self-adhesive • Inscription possible	5ST2 173	027	0.038	1 set
	Labeling systems The labeling program can be downloaded free of charge from: www.siemens.com/beta Recommended labels ELAT-3-747 can be ordered from: Brady GmbH Otto-Hahn-Str. 5-7 63222 Langen Tel: 06103/7598-660				

Miniature Circuit-Breakers

Power Supply Company Product Range

5SP3, 25 kA

Overview

Voltage-independent and selective main miniature circuit-breakers (SHU) according to DIN VDE 0645

Selective main miniature circuit-breakers are generally based on the function principle of ordinary miniature circuit-breakers and are equipped with a delayed thermal release for overload protection, as well as an electromagnetic fast release with an impact cutout blade for short-circuit protection.

In addition, they also comprise a selectivity device which detects whether or not the downstream miniature circuit-breaker in the load circuit is capable of independently coping with a short circuit. If it detects that this will exceed the capacity of the miniature circuit-breaker, the selective main miniature circuit-breaker will trip.

Regardless of the rated current of the SHU switch, this ensures a selectivity for downstream miniature circuit-breakers according to EN 60898 or DIN VDE 0641 Part 11, up to its rated short-circuit capacity.

6 000
3

Furthermore, the selective main miniature circuit-breaker also offers a back-up protection of up to 25 kA to all downstream miniature circuit-breakers.

In the past, melting fuses installed at the meter panel were usually sealed in order to prevent the theft of power supplies.

Due to the various function principles and thus, the different characteristic curves, only limited short-circuit selectivity is possible in a cascade of upstream melting fuses and downstream miniature circuit-breakers. This selectivity also depends on the respective rated currents. This meant that, in the past, if a meter series fuse blew due to an overcurrent or a short circuit, it was necessary to contact the engineers of the power supply company to replace the sealed fuse as this could not be done by non-specialists.

However, the new selective main miniature circuit-breakers can be switched on again – even by non-specialists.

The new selective main miniature circuit-breakers offer the following advantages to system operators:

- Improved current limiting characteristics thanks to the selective main miniature circuit-breakers supporting downstream miniature circuit-breakers
- System-compatibility as no operation characteristics of other devices are influenced – apart from downstream miniature circuit-breakers
- High and safe selectivity between sub-distribution and meter panel
- Safe, fast and cost-favorable on-switching after failures – even by non-specialists
- Prevention of on-switching until the cause of the short-circuit cause has been eliminated
- Tariff monitoring function to assure network-compatible power consumption
- Insulation characteristics with contact position indication according to EN 60204

Application examples

Selectivity towards downstream miniature circuit-breakers up to the rated short-circuit capacity

6 000
3

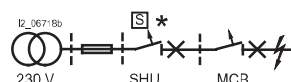

Selectivity towards upstream fuses up to 2 000 A

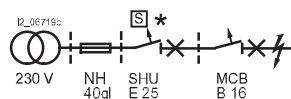

Application

- U_n : 230/400 V, 50-60 Hz, can be used in systems up to 250/440 V AC
- Standards: DIN VDE 0645
- As main miniature circuit-breakers at the meter
- As group miniature circuit-breakers in distribution board applications
- Characteristic E:
Adapted to the special application requirements for cascade circuits between melting fuses and miniature circuit-breakers





At a glance

- Protection of insulated cables against overcurrents
- Disconnection of loads
- Assurance of network-compatible power consumption
- Can be switched on again after failures even by non-specialists
- Complies with defined selectivity requirements for upstream and downstream overcurrent protection devices
- Can be screwed onto mounting plates
- Can be clipped onto busbars using adapters
- Can be snapped onto standard mounting rails using mounting plates according to EN 60715

Miniature Circuit-Breakers Power Supply Company Product Range

5SP3, 25 kA
Accessories

Selection and ordering data

	I_n	MW	Characteristic E Order No.	Price 1 unit	PG	Weight 1 unit approx. kg	PS*/ P. unit Unit(s)
Selective main miniature circuit-breakers							
	16	2	5SP3 716		005	0.550	1 unit
	20		5SP3 720		005	0.550	1 unit
	25		5SP3 725		005	0.550	1 unit
	32		5SP3 732		005	0.550	1 unit
	35		5SP3 735		005	0.550	1 unit
	40		5SP3 740		005	0.550	1 unit
	50		5SP3 750		005	0.550	1 unit
	63		5SP3 763		005	0.550	1 unit
	80		5SP3 780		005	0.550	1 unit
	100	5SP3 791		005	0.550	1 unit	
Selective main miniature circuit-breakers							
	3 x 1-pole, premounted to 5ST1 324 busbar adapter; can be clipped onto busbar (spacing: 40 mm); including three 5ST1 323 transparent operation blocking covers					1 set	
	16	6	5SP3 716-1		005	1.700	1 set
	20		5SP3 720-1		005	1.700	1 set
	25		5SP3 725-1		005	1.700	1 set
	32		5SP3 732-1		005	1.700	1 set
	35		5SP3 735-1		005	1.700	1 set
	40		5SP3 740-1		005	1.700	1 set
	50		5SP3 750-1		005	1.700	1 set
	63		5SP3 763-1		005	1.700	1 set
	80		5SP3 780-1		005	1.700	1 set
			100	5SP3 791-1		005	1.700
Accessories for main miniature circuit-breakers (SHU)							
	Busbar adapters Suitable for a busbar spacing of 40 mm Can be equipped with 3 main miniature circuit-breakers For clip-on assembly		5ST1 328		005	0.234	1 unit
	Breaker blocking covers To prevent manual off-switching		5ST1 318		005	0.001	3 units
	Transparent operation blocking covers Multiple blocking options for preventing accidental and deliberate operation • With padlocks • With cross-tip screwdrivers • With special wrenches (Antilux) • For installation by the operator or the power supply company		5ST1 323		005	0.012	1 unit
		Terminal covers 2 units required per device For covering terminals within the overall dimensions according to DIN 43880		5ST1 316		005	0.001

Overview

Residual current operated circuit-breakers (RCCBs)



5SM3

- Type A
- $I_n = 16 \dots 125 \text{ A}$
- $I_{\Delta n} = 10 \text{ mA} \dots 1 \text{ A}$
- 2-pole (1 + N) and 4-pole (3 + N)
- N connection, right and left
- Versions **K** and **S**
- SIGRES for severe environmental conditions **i**
- Version for 500 V
- Version 50 ... 400 Hz

SIQUENCE residual current operated circuit-breakers (RCCBs), AC/DC sensitive



5SM3

- Type B
- $I_n = 25 \dots 80 \text{ A}$
- $I_{\Delta n} = 30, 300 \text{ mA}$
- 4-pole (3 + N)
- Versions **K** and **S**
- Leakage current measurement unit

SIQUENCE RCCBs with integral overcurrent protection (RCBOs), AC/DC sensitive



5SU1

- Combined personnel and line protection
- Type B
- $I_n = 100, 125 \text{ A}$
- $I_{\Delta n} = 30, 300 \text{ mA}$
- MCB characteristic C, D
- Rated short-circuit capacity 10 kA
- 4-pole
- Version **K**

Residual-current circuit-breakers with integral overcurrent protection (RCBOs)



5SU1

- Combined personnel and line protection
- Type A
- $I_n = 6 \dots 40 \text{ A}$
- $I_{\Delta n} = 10 \dots 300 \text{ mA}$
- Circuit-breaker characteristics B and C
- Rated short-circuit capacity 6 kA and 10 kA
- 2-pole (1 + N)

RC units for miniature circuit-breakers



5SM2

- For mounting on miniature circuit-breakers
- Combined personnel and line protection
- Type A
- $I_n = 0.3 \dots 100 \text{ A}$
- $I_{\Delta n} = 10 \text{ mA} \dots 1 \text{ A}$
- 2, 3 and 4-pole
- Versions **K** and **S**

RC socket outlets



5SM1 and 5SZ9

- Can be retrofitted in existing installations
- Increased protection level
- Type A
- $I_n = 16 \text{ A}$
- $I_{\Delta n} = 10 \text{ and } 30 \text{ mA}$

Accessories



- Locking device
- Cu busbars
- Covers
- Wall enclosure

1 MW = 18 mm modular width

Residual Current Operated Circuit-Breakers

Residual Current Operated Circuit-Breakers (RCCBs)



5SM3, type A, product overview

Overview

	Number of poles	Rated current I_n A	Rated residual current $I_{\Delta n}$ mA	MW	Mountable auxiliary switch	N connection					
						Right	Left				
Residual current operated circuit-breakers, type A¹⁾, 16 ... 125 A											
Instantaneous tripping, surge current withstand capability > 1 kA	2	16	10, 30	2	•	•	--				
		25	30, 100, 300								
		40									
	4	63	30, 100, 300	2.5	•	•	--				
		80									
		25	30, 300 500					4	•	•	--
		40	30, 300 100, 500								
63	30, 300 100, 500	•	•	•	--						
80	30, 300										
125	30, 100, 300, 500	•	•	•	--						
K Short-time delayed, surge current withstand capability > 3 kA	4	25	30	4	•	•	--				
		40									
		63	30, 100					•	•	--	
S Selective, surge current withstand capability > 5 kA	2	63	100, 300	2.5	•	•	--				
		4	40					100, 300	4	•	•
	63	100, 1 000	•	•	•	--					
	4	300		•	•	•	•				
		125	300, 500					•	•	--	
SIGRES residual current operated circuit-breakers, type A¹⁾, for severe environmental conditions I											
Instantaneous tripping, surge current withstand capability > 1 kA	2	25	30	2	•	•	--				
		40									
		63	30					2.5	•	•	--
	80										
	4	25	30	4	•	•	--				
		40	30, 300								
63			•					•	--		
80	30	•	•	--							
S Selective, surge current withstand capability > 5 kA	4	63	300	4	•	•	--				
Residual current operated circuit-breakers, type A¹⁾, 500 V											
Instantaneous tripping, surge current withstand capability > 1 kA	4	25	30, 300	4	•	•	--				
		40									
		63						•	•	--	
Residual current operated circuit-breakers, type A¹⁾, 50 ... 400 Hz											
Instantaneous tripping, surge current withstand capability > 1 kA	4	25	30	4	•	•	--				
		40						•	•	--	
Residual current operated circuit-breakers, type A¹⁾, 24 ... 125 V											
Instantaneous tripping, surge current withstand capability > 1 kA	2	16	30	2	•	•	--				

1) = Type A for AC and pulsating DC residual currents

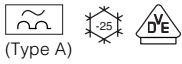

Residual Current Operated Circuit-Breakers

Residual Current Operated Circuit-Breakers (RCCBs)

5SM3, Type A, 16 ... 125 A

Benefits

- Terminals with wire protection can be directly busbar-mounted with devices with terminals in the modular width, e.g. with 5SY miniature circuit-breakers.
- An auxiliary circuit switch can be fitted to the right-hand side of the enclosure by the customer.
- Operating handle and test button can be locked by means of a handle locking device.
- N connection on the left allows simple busbar mounting with pin busbars if the miniature circuit-breakers are fitted on the right.

- Product standards: IEC/EN 61008-1 (VDE 0664, Part 10); IEC 61008-2-1 (VDE 0664, Part 11); IEC/EN 61543 (VDE 0664, Part 30)
- U_n 230/400 V; 50 to 60 Hz; can be used in systems up to: 240/415 V AC
- Definition of surge current withstand capability with current waveform 8/20 μ s according to DIN VDE 0432, Part 2
- **S** S type: can be used as upstream group switch for selective tripping contrary to a downstream standard RCCB. Very high surge current withstand capability: > 5 kA.
- **K** K type: short-time delayed tripping in the case of transient leakage currents. High surge current withstand capability: > 3 kA.

Application

- Personnel and fire protection
 - $I_{\Delta n} \leq 30$ mA: additional protection in the case of direct contact
 - $I_{\Delta n} \leq 300$ mA: preventative fire protection in the case of ground fault currents

Selection and ordering data

Circuit diagram Max. permissible short-circuit series fuse	Rated residual current $I_{\Delta n}$ mA	Rated current I_n A	MW	N connection, right		N connection, left		PG	Weight 1 unit approx. kg	PS*/ P. unit Unit(s)		
				Order No.	Price 1 unit	Order No.	Price 1 unit					
Instantaneous tripping, surge current withstand capability > 1 kA												
125 ... 230 V AC; 50 ... 60 Hz; 2-pole												
	10	16	2	5SM3 111-6	--	--	007	0.230	1 unit			
	30	16		5SM3 311-6	--	--	007	0.230	1 unit			
	25	25		5SM3 312-6	--	--	007	0.230	1 unit			
	40	40		5SM3 314-6	--	--	007	0.230	1 unit			
	100	25		5SM3 412-6	--	--	007	0.230	1 unit			
	40	40		5SM3 414-6	--	--	007	0.230	1 unit			
	300	25	5SM3 612-6	--	--	007	0.210	1 unit				
	40	40	5SM3 614-6	--	--	007	0.210	1 unit				
	230 ... 400 V AC; 50 ... 60 Hz; 4-pole											
		30	25	4	5SM3 342-6	5SM3 342-6KL	007	0.500	1 unit			
		40	40		5SM3 344-6	5SM3 344-6KL	007	0.500	1 unit			
		63	63		5SM3 346-6	5SM3 346-6KL	007	0.500	1 unit			
80		80	5SM3 347-6		5SM3 347-6KL	007	0.500	1 unit				
100		40	5SM3 444-6		--	007	0.460	1 unit				
63		63	5SM3 446-6		--	007	0.460	1 unit				
	300	25	5SM3 642-6	5SM3 642-6KL	007	0.440	1 unit					
	40	40	5SM3 644-6	5SM3 644-6KL	007	0.440	1 unit					
	63	63	5SM3 646-6	5SM3 646-6KL	007	0.440	1 unit					
	80	80	5SM3 647-6	5SM3 647-6KL	007	0.440	1 unit					
	500	25	5SM3 742-6	--	007	0.440	1 unit					
	40	40	5SM3 744-6	--	007	0.440	1 unit					
63	63	5SM3 746-6	--	007	0.440	1 unit						
	30	125	125	5SM3 345-6	--	007	0.500	1 unit				
	100	100		5SM3 445-6	--	007	0.480	1 unit				
	300	300		5SM3 645-6	--	007	0.480	1 unit				
	500	500		5SM3 745-6	--	007	0.480	1 unit				
	125 ... 230 V AC; 50 ... 60 Hz; 4-pole											
		30		125	125	5SM3 345-6	--	007	0.500	1 unit		
100		100	5SM3 445-6	--		007	0.480	1 unit				
300		300	5SM3 645-6	--		007	0.480	1 unit				
500		500	5SM3 745-6	--		007	0.480	1 unit				

* You can order this quantity or a multiple thereof.

Residual Current Operated Circuit-Breakers

Residual Current Operated Circuit-Breakers (RCCBs)

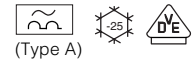

5SM3, Type A, 16 ... 125 A

Circuit diagram Max. permissible short-circuit series fuse	Rated residual current $I_{\Delta n}$ mA	Rated current I_n A	MW	N connection, right		N connection, left		PG	Weight 1 unit approx. kg	PS*/ P. unit Unit(s)
				Order No.	Price 1 unit	Order No.	Price 1 unit			
[K] Short-time delayed, surge current withstand capability > 3 kA										
230 ... 400 V AC; 50 ... 60 Hz; 4-pole										
 I2_05977d 100 A 	30	25	4	5SM3 342-6KK01	--	--	007	0.500	1 unit	
	30	40		5SM3 344-6KK01	--	--	007	0.500	1 unit	
	100	63		5SM3 346-6KK01	--	--	007	0.500	1 unit	
	100	63		5SM3 446-6KK01	--	--	007	0.460	1 unit	
[S] Selective, surge current withstand capability > 5 kA										
125 ... 230 V AC; 50 ... 60 Hz; 2-pole										
 I2_05952c 100 A 	100	63	2.5	5SM3 416-8	--	--	007	0.300	1 unit	
	300	63		5SM3 616-8	--	--	007	0.280	1 unit	
230 ... 400 V AC; 50 ... 60 Hz; 4-pole										
 I2_05977d 100 A 	100	40	4	5SM3 444-8	--	--	007	0.460	1 unit	
	63	40		5SM3 446-8	--	--	007	0.460	1 unit	
	300	40		5SM3 644-8	--	--	007	0.440	1 unit	
	63	63		5SM3 646-8	--	5SM3 646-8KL	007	0.440	1 unit	
	1 000	63		5SM3 846-8	--	--	007	0.515	1 unit	
N connection, right										
 I2_10730 100 A 	100	40	4	5SM3 444-8	--	--	007	0.460	1 unit	
	63	40		5SM3 446-8	--	--	007	0.460	1 unit	
N connection, left										
 I2_06232c 125 A 	300	125	4	5SM3 645-8	--	--	007	0.480	1 unit	
	500	125		5SM3 745-8	--	--	007	0.480	1 unit	

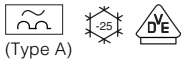

Residual Current Operated Circuit-Breakers

Residual Current Operated Circuit-Breakers (RCCBs)

5SM3, type A, SIGRES,
for severe environmental conditions **[i]**, 25 ... 80 A

Benefits

- Our patented active condensation protection significantly increases endurance under harsh ambient conditions
- Terminals with wire protection can be directly busbar-mounted with devices with terminals in the modular width, e.g. with 5SY miniature circuit-breakers.
- An auxiliary circuit switch can be fitted to the right-hand side of the enclosure by the customer.
- Operating handle and test button can be locked by means of a handle locking device.

Application

- For use in areas with high levels of pollution gas and humidity, such as indoor swimming pools, in agriculture, construction distribution boards or in the chemical industry
- Personnel and fire protection
 - $I_{\Delta n} \leq 30$ mA: additional protection in the case of direct contact
 - $I_{\Delta n} \leq 300$ mA: preventative fire protection in the case of ground fault currents
- Product standards: IEC/EN 61008-1 (VDE 0664, Part 10); IEC 61008-2-1 (VDE 0664, Part 11); IEC/EN 61543 (VDE 0664, Part 30)
- U_n 230/400 V; 50 to 60 Hz; can be used in systems up to: 240/415 V AC
- Definition of surge current withstand capability with current waveform 8/20 μ s according to DIN VDE 0432, Part 2
- **[S]** S type: can be used as upstream group switch for selective tripping contrary to a downstream standard RCCB. Very high surge current withstand capability: > 5 kA.

Function

- Function of condensation protection with deactivated RCCBs through supply from below (terminals 2/N or 2/4/6/N).

Selection and ordering data

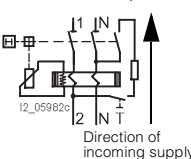
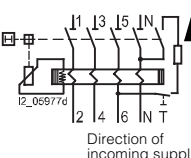
Circuit diagram	Maximum permissible short-circuit series fuse	Rated residual current $I_{\Delta n}$ mA	Rated current I_n A	MW	Ver- sion	Order No.	Price 1 unit	PG	Weight 1 unit approx. kg	PS*/ P. unit Unit(s)
[i] Instantaneous tripping, surge current withstand capability > 1 kA										
 <p>125 ... 230 V AC; 50 ... 60 Hz; 2-pole</p> <p>Direction of incoming supply</p>	63 A	30	25	2	[i]	5SM3 312-6KK12		007	0.230	1 unit
	100 A	30	40	2	[i]	5SM3 314-6KK12		007	0.230	1 unit
	100 A	63	63	2.5	[i]	5SM3 316-6KK12		007	0.320	1 unit
	100 A	80	80	2.5	[i]	5SM3 317-6KK12		007	0.320	1 unit
 <p>230 ... 400 V AC; 50 ... 60 Hz; 4-pole</p> <p>Direction of incoming supply</p>	100 A	30	25	4	[i]	5SM3 342-6KK12		007	0.500	1 unit
	100 A	30	40	4	[i]	5SM3 344-6KK12		007	0.500	1 unit
	100 A	63	63	4	[i]	5SM3 346-6KK12		007	0.500	1 unit
	100 A	80	80	4	[i]	5SM3 347-6KK12		007	0.500	1 unit
	100 A	300	40	4	[i]	5SM3 644-6KK12		007	0.440	1 unit
	100 A	300	63	4	[i]	5SM3 646-6KK12		007	0.440	1 unit
[i], [S] Selective, surge current withstand capability > 5 kA										
		300	63	4	[i] [S]	5SM3 646-8KK12		007	0.440	1 unit

* You can order this quantity or a multiple thereof.

Residual Current Operated Circuit-Breakers

Residual Current Operated Circuit-Breakers (RCCBs)

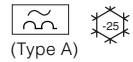

5SM3, type A, 500 V, 25 ... 63 A
5SM3, type A, 50 ... 400 Hz, 25 ... 40 A

Benefits

- Terminals with wire protection can be directly busbar-mounted with devices with terminals in the modular width, e.g. with 5SY miniature circuit-breakers.
- An auxiliary circuit switch can be fitted to the right-hand side of the enclosure by the customer
- Operating handle and test button can be locked by means of a handle locking device

Application

- Personnel and fire protection
 - $I_{\Delta n} \leq 30$ mA: additional protection in the case of direct contact
 - $I_{\Delta n} \leq 300$ mA: preventative fire protection in the case of ground fault currents
- Product standards: IEC/EN 61008-1 (VDE 0664, Part 10); IEC 61008-2-1 (VDE 0664, Part 11); IEC/EN 61543 (VDE 0664, Part 30); VDE 0664 Part 101
- U_n 500 V; 50 to 60 Hz; can be used in systems up to: 500 V AC
- Definition of surge current withstand capability with current waveform 8/20 μ s according to DIN VDE 0432, Part 2

Selection and ordering data

Circuit diagram	Maximum permissible short-circuit series fuse	Rated residual current $I_{\Delta n}$ mA	Rated current I_n A	MW	Ver- sion	Order No.	Price 1 unit	PG	Weight 1 unit approx.	PS*/ P. unit
Instantaneous tripping, surge current withstand capability > 1 kA¹⁾										
<p>500 V AC; 50 ... 60 Hz; 4-pole</p>		30	25	4		5SM3 352-6		007	0.500	1 unit
			40			5SM3 354-6			0.500	1 unit
			63			5SM3 356-6			0.500	1 unit
		300	25		5SM3 652-6	0.440	1 unit			
			40		5SM3 654-6	0.440	1 unit			
			63		5SM3 656-6	0.440	1 unit			

Benefits

- Terminals with wire protection can be directly busbar-mounted with devices with terminals in the modular width, e.g. with 5SY miniature circuit-breakers.
- An auxiliary circuit switch can be fitted to the right-hand side of the enclosure by the customer
- Operating handle and test button can be locked by means of a handle locking device

Application

- For use with line frequencies between 50 and 400 Hz
- Personnel and fire protection
 - $I_{\Delta n} \leq 30$ mA: additional protection in the case of direct contact
- Product standards: IEC/EN 61008-1 (VDE 0664, Part 10); IEC 61008-2-1 (VDE 0664, Part 11); IEC/EN 61543 (VDE 0664, Part 30)
- U_n 230/400 V; 50 to 400 Hz; can be used in systems up to: 240/415 V AC
- Definition of surge current withstand capability with current waveform 8/20 μ s according to DIN VDE 0432, Part 2

Selection and ordering data

Circuit diagram	Maximum permissible short-circuit series fuse	Rated residual current $I_{\Delta n}$ mA	Rated current I_n A	MW	Ver- sion	Order No.	Price 1 unit	PG	Weight 1 unit approx.	PS*/ P. unit
Instantaneous tripping, surge current withstand capability > 1 kA¹⁾										
<p>230 ... 400 V AC; 50 ... 400 Hz; 4-pole</p>		30	25	4		5SM3 342-6KK03		007	0.500	1 unit
			40			5SM3 344-6KK03			0.500	1 unit

1)

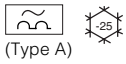

Residual Current Operated Circuit-Breakers

Residual Current Operated Circuit-Breakers (RCCBs)

5SM3, type A, 24 V, 16 A

Benefits

- Terminals with wire protection can be directly busbar-mounted with devices with terminals in the modular width, e.g. with 5SY miniature circuit-breakers.
- An auxiliary circuit switch can be fitted to the right-hand side of the enclosure by the customer.
- Operating handle and test button can be locked by means of a handle locking device.

Application

- For special applications (e.g. laboratories)
- Personnel and fire protection
 - $I_{\Delta n} = 30$ mA: additional protection in case of direct contact
- Product standards: IEC/EN 61008-1 (VDE 0664, Part 10); IEC 61008-2-1 (VDE 0664, Part 11); IEC/EN 61543 (VDE 0664, Part 30)
- U_n 24 to 125 V; 50 to 60 Hz; can be used in systems: 125 V AC
- Definition of surge current withstand capability with current wave-form 8/20 μ s to DIN VDE 0432, Part 2

Selection and ordering data

Circuit diagram	Maximum permissible short-circuit series fuse	Rated residual current $I_{\Delta n}$ mA	Rated current I_n A	MW	Ver-sion	Order No.	Price 1 unit	PG	Weight 1 unit approx. kg	PS*/P. unit Unit(s)
-----------------	---	--	-----------------------------	----	----------	-----------	--------------	----	-----------------------------	------------------------

Instantaneous tripping, surge current withstand capability > 1 kA



24 ... 125 V AC; 50 ... 60 Hz; 2-pole

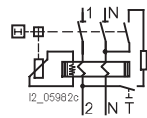

30 16 2

5SM3 311-6KK13

007 0.230 1 unit

* You can order this quantity or a multiple thereof.

Residual Current Operated Circuit-Breakers

SIQUENCE RCCBs, AC/DC Sensitive

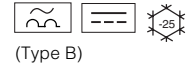

5SM3, type B, product overview

5SM3, type B, 25 ... 80 A

Overview

	Number of poles	Rated current I_n A	Rated residual current $I_{\Delta n}$ mA	MW	Mountable auxiliary switch	N connection Right
SIQUENCE residual current operated circuit-breakers, type B¹⁾, 25 ... 80 A						
K Short-time delayed, surge current withstand capability > 3 kA	4	25 40 63 80	30, 300	4	• • • •	• • • •
S Selective, surge current withstand capability > 5 kA	4	63 80	300	4	• •	• •

1) = Type B for AC fault currents, pulsating and smooth DC fault currents.

Benefits

- AC/DC sensitive: For detection of AC fault currents, pulsating and smooth DC residual currents
- Terminals with wire protection can be directly busbar-mounted with devices with terminals in the modular width, e.g. with 5SY miniature circuit-breakers.
- Increased operating safety in systems with capacitive impedances due to adapted tripping characteristic
- An auxiliary circuit switch can be fitted to the right-hand side of the enclosure by the customer.
- Operating handle and test button can be locked by means of a handle locking device.

Application

- Systems with equipment in which smooth DC fault currents can also arise (e.g. with B6 bridge circuit on frequency converters and medical equipment)
- Personnel and fire protection
 - $I_{\Delta n} \leq 30$ mA: additional protection in the case of direct contact
 - $I_{\Delta n} \leq 300$ mA: preventative fire protection in the case of ground fault currents
- Product standards: IEC/EN 61008-1 (VDE 0664, Part 10); VDE 0664 Part 100; IEC/EN 61543 (VDE 0664, Part 30)
- For use in 3-phase current systems
- U_n 230/400 V; 50 to 60 Hz; can be used in systems up to: 240/415 V AC
- Definition of surge current withstand capability with current waveform 8/20 μ s according to DIN VDE 0432, Part 2
- **S** type: can be used as upstream group switch for selective tripping compared with downstream standard RCCBs. Very high surge current withstand capability: > 5 kA.
- **K** type: short-time delayed tripping in the case of transient leakage currents. High surge current withstand capability: > 3 kA.

Selection and ordering data

Circuit diagram	Maximum permissible short-circuit series fuse	Rated residual current	Rated current	MW	Version	Order No.	Price 1 unit	PG	Weight	PS*/P. unit
		$I_{\Delta n}$ mA	I_n A						1 unit approx.	Unit(s)
K Short-time delayed, surge current withstand capability > 3 kA										
	230 ... 400 V AC; 50 ... 60 Hz; 4-pole									
	30	25	4	K	5SM3 342-4	008	0.520	1 unit		
		40		K	5SM3 344-4	008	0.520	1 unit		
		63		K	5SM3 346-4	008	0.520	1 unit		
		80		K	5SM3 347-4	008	0.520	1 unit		
	300	25	4	K	5SM3 642-4	008	0.520	1 unit		
		40		K	5SM3 644-4	008	0.520	1 unit		
		63		K	5SM3 646-4	008	0.520	1 unit		
		80		K	5SM3 647-4	008	0.520	1 unit		
	S Selective, surge current withstand capability > 5 kA									
230 ... 400 V AC; 50 ... 60 Hz; 4-pole										
300	63	4	S	5SM3 646-5	008	0.520	1 unit			
	80		S	5SM3 647-5	008	0.520	1 unit			

Residual Current Operated Circuit-Breakers Supplementary Components/Accessories for RCCBs

Remote controlled operating mechanisms, auxiliary switches for 5SM3

Benefits

- Can be retrofitted individually
- Mounting with factory-fitted brackets
- Can be mechanically latched and locked
- An auxiliary circuit switch can also be retrofitted to the remote controlled mechanism
- Function switch on the front
- Connectable to *instabus* KNX *EIB* and AS-Interface bus through binary inputs and outputs
- $U_n = 230$ V, 50 to 60 Hz

Function

- Remote ON/OFF switching of 5SM3 RCCBs (≤ 80 A)
- Remote ON switching possible following acknowledgment of fault occurrence
- Manual switching on-site possible
- Remote display of switching status of remote controlled mechanisms and RCCBs.

Selection and ordering data

	Rated voltage U_n	MW	Order No.	Price 1 unit	PG	Weight 1 unit approx.	PS*/ P. unit
	V AC					kg	Unit(s)
Remote-controlled operating mechanisms for 5SM3 RCCBs (≤ 80 A)							
	230	3.5	5ST3 051		027	0.395	1 unit

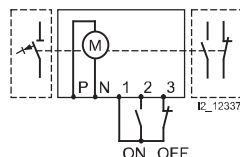

For detailed application information, see Operator's Guide.

Benefits



- An auxiliary circuit switch can be fitted to the right-hand side of the RCCB enclosure by the customer
- Mounting with factory-fitted brackets
- Can be connected to *instabus* KNX *EIB* and AS-Interface bus or PROFIBUS through binary inputs.

Application

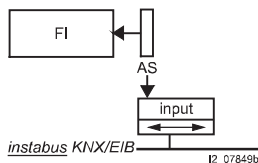
- Indications of the circuit state of the RCCB: ON/OFF
- Short-circuit protection ensured by miniature circuit-breakers of characteristic B or C with $I_n = 6$ A or fuse gL 6 A
- Product standards: IEC/EN 62019 (VDE 0640)



Selection and ordering data



	Circuit diagram	Version	MW	Order No.	Price 1 unit	PG	Weight 1 unit approx.	PS*/ P. unit
							kg	Unit(s)
Auxiliary circuit switches (AS) on RCCB for 5SM3 up to 80 A								
	Auxiliary switches (AS) 21 13 22 14	1 NO + 1 NC	0.5	5SW3 300		008	0.042	1 unit
	21 11 22 12	2 NC	0.5	5SW3 301		008	0.042	1 unit
	23 13 24 14	2 NO	0.5	5SW3 302		008	0.042	1 unit
Auxiliary circuit switches (AS) on RCCBs for 5SM3, 125 A								
	Auxiliary switches (AS) 23 11 24 12	1 NO + 1 NC	0.5	5SW3 330		008	0.040	1 unit

* You can order this quantity or a multiple thereof.

Residual Current Operated Circuit-Breakers Supplementary Components/Accessories for RCCBs



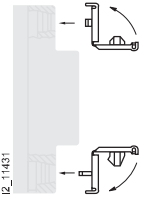







Accessories for 5SM3

Accessories

Version	Order No.	Price 1 unit	PG	Weight 1 unit approx. kg	PS*/ P. unit Unit(s)
 <p>Covers for connection terminals For residual current operated circuit-breakers up to 80 A Sealable (2 parts in plastic bag)</p> <p>2 MW 2.5 MW 4 MW</p>	5SW3 010		008	0.003	1 unit
	5SW3 011		008	0.004	1 unit
	5SW3 008		008	0.006	1 unit
 <p>Locking devices For RCCBs up to 80 A Sealable and lockable 4.5 mm lock hasp diameter</p>	5SW3 303		008	0.008	1 unit
 <p>Padlocks For 5SW3 303 locking device</p> <p>Locking devices with padlock Consists of 5SW3 303 locking device and 5ST3 802 padlock</p>	5ST3 802		027	0.027	1 unit
	5SW3 312		008	0.035	1 set

Residual Current Operated Circuit-Breakers Supplementary Components/Accessories for RCCBs

Accessories for 5SM3

Version	Order No.	Price 1 unit	PG	Weight 1 unit approx. kg	PS*/ P. unit Unit(s)
Cu busbars 10 mm²					
For the busbar mounting of RCCBs					
Fully insulated					
2-phase					
 5ST3 606	2 x 2-phase	5ST3 606	027	0.016	1 unit
	3 x 2-phase	5ST3 607	027	0.024	1 unit
	6 x 2-phase	5ST3 608	027	0.048	1 unit
 5ST3 610 5ST3 611 5ST3 612	2 x (2-phase + AS)	5ST3 610	027	0.020	1 unit
	3 x (2-phase + AS)	5ST3 611	027	0.030	1 unit
	5 x (2-phase + AS)	5ST3 612	027	0.050	1 unit
3-phase					
 5ST3 613 5ST3 614 5ST3 615	2 x 3-phase	5ST3 613	027	0.039	1 unit
	3 x 3-phase	5ST3 614	027	0.060	1 unit
	4 x 3-phase	5ST3 615	027	0.076	1 unit
	2 x (3-phase + AS)	5ST3 616	027	0.040	1 unit
	4 x (3-phase + AS)	5ST3 617	027	0.080	1 unit
3-phase + N					
	2 x 3-phase + N	5ST3 621	027	0.051	1 unit
	3 x 3-phase + N	5ST3 622	027	0.078	1 unit
3-phase, for a 5SM3 4-pole RCCB with 8 miniature circuit-breakers					
	3/N + 8 connections	5ST3 624	027	0.075	1 unit
Without end caps Length 1016 mm					
 5ST3 735 5ST3 737 5ST3 740	2-phase	5ST3 735	027	0.290	1 unit
	2-phase + AS	5ST3 737	027	0.290	1 unit
	3-phase	5ST3 740	027	0.430	1 unit
Cu busbars 16 mm²					
For the busbar mounting of RCCBs					
Fully insulated					
2-phase					
 5ST3 636 5ST3 637 5ST3 638	2 x 2-phase	5ST3 636	027	0.024	1 unit
	3 x 2-phase	5ST3 637	027	0.039	1 unit
	6 x 2-phase	5ST3 638	027	0.076	1 unit
 5ST3 640 5ST3 641 5ST3 642	2 x (2-phase + AS)	5ST3 640	027	0.026	1 unit
	3 x (2-phase + AS)	5ST3 641	027	0.045	1 unit
	5 x (2-phase + AS)	5ST3 642	027	0.084	1 unit
3-phase					
 5ST3 643 5ST3 644 5ST3 645	2 x 3-phase	5ST3 643	027	0.058	1 unit
	3 x 3-phase	5ST3 644	027	0.083	1 unit
	4 x 3-phase	5ST3 645	027	0.110	1 unit
	2 x (3-phase + AS)	5ST3 646	027	0.060	1 unit
	4 x (3-phase + AS)	5ST3 647	027	0.120	1 unit
3-phase + N					
	2 x 3-phase + N	5ST3 651	027	0.080	1 unit
	3 x 3-phase + N	5ST3 652	027	0.116	1 unit
3-phase, for a 5SM3 4-pole RCCB with 8 miniature circuit-breakers					
	3/N + 8 connections	5ST3 654	027	0.114	1 unit
Without end caps Length 1016 mm					
 5ST3 705 5ST3 707 5ST3 710	2-phase	5ST3 705	027	0.290	1 unit
	2-phase + AS	5ST3 707	027	0.290	1 unit
	3-phase	5ST3 710	027	0.430	1 unit
 5ST3 750	End caps For lateral insulation of cut-to-length busbars	5ST3 750		0.001	1 unit
			2 and 3-phase		
 5ST3 655	Touch protection For free connections, yellow (RAL 1004)	5ST3 655	027	0.003	1 unit

For more busbar versions,
see Accessories for Miniature Circuit-Breakers.
AS: auxiliary circuit switch

* You can order this quantity or a multiple thereof.

Siemens LV 1 · 2006

19/93

Residual Current Operated Circuit-Breakers Supplementary Components/Accessories for RCCBs

5SM1 930 leakage current measurement units

Benefits

- The leakage current measurement unit enables systematic selection of the rated residual current for the RCCB, thus preventing accidental trippings. The measured leakage current should be a maximum of 1/3 of the rated residual current of the RCCB. If this condition is not met due to the rated current required to protect the RCCB, remedial action must be taken at the equipment that generates the leakage current.
- The detection of causes for the unintended tripping of the RCCB is considerably simplified, especially with regard to large systems.
- Matching of measuring curve, particularly on residual current operated circuit-breakers, universal current sensitive (Type B)
- Mounting depth 55 mm

Application

- Rated voltage: up to 500 V AC; 50 to 60 Hz
- For measuring leakage currents of up to 300 mA in electrical systems
- Using the enclosed calibration curve, a voltmeter with an internal resistance of $> 1 \text{ M}\Omega/\text{V}$ can determine the leakage current. Measuring range for AC voltage: U_{rms} : 1 mV to 2 V

Selection and ordering data

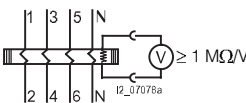
Circuit diagram	Rated residual current $I_{\Delta n}$ mA	Rated current I_n A	MW	Order No.	Price 1 unit	PG	Weight 1 unit approx. kg	PS*/ P. unit Unit(s)
 <p>500 V AC; 50 ... 60 Hz; 4-pole</p>	0 ... 300	63	4	5SM1 930-0		008	0.430	1 unit

Gossen-Metrawatt offers suitable test devices for RCCB function tests and for testing protective measures.

Information is available at:

Gossen-Metrawatt GmbH,
Thomas-Mann-Str. 16-20,
90 471 Nürnberg, Germany

Tel. +49 (0)911 86 02 111

Fax +49 (0)911 86 02 777

<http://www.gmc-instruments.com>

E-mail:

info@gmc-instruments.com

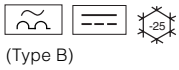

(Type B)

Residual Current Operated Circuit-Breakers

SIQUENCE RCCBs with Integral Overcurrent Protection (RCBOs), AC/DC Sensitive

5SU1, type B, product overview
5SU1, type B, 100 ... 125 A

Overview

	Number of poles	Rated current I_n A	Rated fault current $I_{\Delta n}$ mA	MW	Additional components can be retrofitted
SIQUENCE RCBO, type B¹⁾, 100 ... 125 A					
Short-time delayed tripping, surge current withstand capability > 3kA					
Rated short-circuit capacity 10 kA					
• Rated voltage 400 V AC Characteristic C	4	100 125	30, 300	11	•
• Rated voltage 400 V AC Characteristic D	4	100	30, 300	11	•
• Rated voltage 480 V AC Characteristic C	4	100 125	300	11	•

1) = Type B for AC fault currents, pulsating and smooth DC fault currents

Benefits

- AC/DC sensitive: For detection of AC fault currents, pulsating and smooth DC residual currents
- Time-saving wiring and simplified device coordination thanks to RCCBs for combined personnel and line protection in a single device
- Increased operating safety in systems with capacitive impedances due to adapted tripping characteristic
- Additional components can be retrofitted by the customer
- External remote tripping over Y1/Y2 terminals

Application

- Systems with equipment in which smooth DC fault currents can also arise (e.g. with B6 bridge circuit on frequency converters and medical equipment)
- Product standards: IEC/EN 61009-1 (VDE 0664, Part 10); VDE 0664 Part 200; IEC/EN 61543 (VDE 0664, Part 30)
- For use in 3-phase current systems
- $U_n = 400$ V or $U_n = 480$ V; 50 ... 60 Hz
- Definition of surge current withstand capability with current waveform 8/20 μ s according to DIN VDE 0432 Part 2
- **K** type: short-time delayed tripping in the case of transient leakage currents. High surge current withstand capability: > 3kA

Selection and ordering data

Circuit diagram Max. permissible short-circuit series fuse	Rated residual current $I_{\Delta n}$ mA	Rated current I_n A	MW	MCB characteristic C		PG	Weight 1 unit approx. kg	PS*/ P. unit Unit(s)
				Order No.	Price 1 unit			
K Short-time delayed, surge current withstand capability > 3 kA								
<p>400 V AC; 50 ... 60 Hz; 4-pole</p>	300	100	11	5SU1 374-7AK81	5SU1 374-8AK81	011	1.950	1 unit
		125	11	5SU1 374-7AK82	--	011	1.950	1 unit
		100	11	5SU1 674-7AK81	5SU1 674-8AK81	011	1.950	1 unit
		125	11	5SU1 674-7AK82	--	011	1.950	1 unit
<p>480 V AC; 50 ... 60 Hz; 4-pole</p>	300	100	11	5SU1 674-7CK81	--	011	1.950	1 unit
125		11	5SU1 674-7CK82	--	011	1.950	1 unit	

* You can order this quantity or a multiple thereof.

Residual Current Operated Circuit-Breakers RCCBs with Integral Overcurrent Protection (RCBOs)

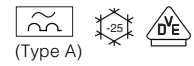

5SU1, type A, product overview

Overview

	Number of poles	Rated current I_n A	Rated fault current $I_{\Delta n}$ mA	MW	Additional components can be retrofitted
RCBOs, type A¹⁾, 6 ... 40 A					
Instantaneous tripping, surge current withstand capability > 1 kA					
Rated short-circuit capacity 6 kA 6 000					
• Characteristic B and C 3					
	2	6	30, 300	2	•
		8	30		•
		10	30, 300		•
		13			•
		16			•
		20	30, 300		•
25		•			
32		•			
40		•			
Rated short-circuit capacity 10 kA 10 000					
• Characteristic B and C 3					
	2	6	10, 30, 300	2	•
		8	30		•
		10	10, 30, 300		•
		13			•
		16			•
		20	30, 300		•
		25			•
		32			•
		40			•

1) = Type A for AC and pulsating DC residual currents

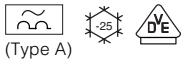

Residual Current Operated Circuit-Breakers RCCBs with Integral Overcurrent Protection (RCBOs)

5SU1, type A, 6 ... 40 A

Benefits

- Compact device version for personnel and line protection
- Simplified device co-ordination thanks to unit comprising residual current operated circuit-breaker (RCCB) and miniature circuit-breaker
- Saves time with wiring
- Maximum plant availability thanks to assignment of a device to a specific electrical circuit
- Excellent current limiting and selectivity characteristics
- Combination terminal for simultaneous connection of pin busbars and feeder cables
- Simple connection of feeder cables due to rear relocation of busbar connection
- Identical terminals at both sides for optional infeed from the top or the bottom
- Operating handle and test button can be locked by means of a handle locking device
- Customers can retrofit additional components to the miniature circuit-breakers for additional uses

Additional features of the 10 kA version:

- Reach-round protection exceeds requirements according to BGV A2
- No tools required for standard rail mounting or dismounting
- Separate switching position indicator

Application

- Personnel and fire protection
 - $I_{\Delta n} \leq 30$ mA: additional protection in the case of direct contact
 - $I_{\Delta n} \leq 300$ mA: preventative fire protection in the case of ground fault currents
- Cable and line protection against overload and short-circuits
- Product standards: IEC/EN 61009-1 (VDE 0664, Part 20); IEC/EN 61009-2-1 (VDE 0664, Part 21); IEC/EN 61543 (VDE 0664, Part 30)
- $U_n = 230$ V; 50 ... 60 Hz
- Miniature circuit-breaker characteristic B or C
- Definition of surge current withstand capability with current waveform 8/20 μ s according to DIN VDE 0432, Part 2

Selection and ordering data

Circuit diagram Max. permissible short-circuit series fuse	Rated residual current $I_{\Delta n}$ mA	Rated current I_n A	MW	MCB characteristic B		MCB characteristic C		PG	Weight 1 unit approx. kg	PS*/ P. unit Unit(s)
				Order No.	Price 1 unit	Order No.	Price 1 unit			

Instantaneous tripping, surge current withstand capability > 1 kA

230 V AC; 50 ... 60 Hz; 1-pole + N		230 V AC; 50 ... 60 Hz; 2- (1 + N)-pole						
	30	6	2	5SU1 356-6KK06	5SU1 356-7KK06	011	0.260	1 unit
		8	2	5SU1 356-6KK10	5SU1 356-7KK08	011	0.260	1 unit
		10	2	5SU1 356-6KK13	5SU1 356-7KK10	011	0.260	1 unit
		13	2	5SU1 356-6KK16	5SU1 356-7KK13	011	0.260	1 unit
		16	2	5SU1 356-6KK16	5SU1 356-7KK16	011	0.260	1 unit
		20	2	5SU1 356-6KK20	5SU1 356-7KK20	011	0.260	1 unit
	300	25	2	5SU1 356-6KK25	5SU1 356-7KK25	011	0.260	1 unit
		32	2	5SU1 356-6KK32	5SU1 356-7KK32	011	0.260	1 unit
		40	2	5SU1 356-6KK40	5SU1 356-7KK40	011	0.260	1 unit
		6	2	5SU1 656-6KK06	5SU1 656-7KK06	011	0.260	1 unit
		10	2	5SU1 656-6KK10	5SU1 656-7KK10	011	0.260	1 unit
		13	2	5SU1 656-6KK13	5SU1 656-7KK13	011	0.260	1 unit
		16	2	5SU1 656-6KK16	5SU1 656-7KK16	011	0.260	1 unit
		20	2	5SU1 656-6KK20	5SU1 656-7KK20	011	0.260	1 unit
		25	2	5SU1 656-6KK25	5SU1 656-7KK25	011	0.260	1 unit
		32	2	5SU1 656-6KK32	5SU1 656-7KK32	011	0.260	1 unit
40	2	5SU1 656-6KK40	5SU1 656-7KK40	011	0.260	1 unit		
	10	6	2	5SU1 154-6KK06	5SU1 154-7KK06	011	0.260	1 unit
		10	2	5SU1 154-6KK10	5SU1 154-7KK10	011	0.260	1 unit
		13	2	5SU1 154-6KK13	5SU1 154-7KK13	011	0.260	1 unit
		16	2	5SU1 154-6KK16	5SU1 154-7KK16	011	0.260	1 unit
	30	6	2	5SU1 354-6KK06	5SU1 354-7KK06	011	0.260	1 unit
		8	2	5SU1 354-6KK06	5SU1 354-7KK08	011	0.260	1 unit
		10	2	5SU1 354-6KK10	5SU1 354-7KK10	011	0.260	1 unit
		13	2	5SU1 354-6KK13	5SU1 354-7KK13	011	0.260	1 unit
		16	2	5SU1 354-6KK16	5SU1 354-7KK16	011	0.260	1 unit
		20	2	5SU1 354-6KK20	5SU1 354-7KK20	011	0.260	1 unit
		25	2	5SU1 354-6KK25	5SU1 354-7KK25	011	0.260	1 unit
		32	2	5SU1 354-6KK32	5SU1 354-7KK32	011	0.260	1 unit
	40	2	5SU1 354-6KK40	5SU1 354-7KK40	011	0.260	1 unit	
	300	6	2	5SU1 654-6KK06	5SU1 654-7KK06	011	0.260	1 unit
		10	2	5SU1 654-6KK10	5SU1 654-7KK10	011	0.260	1 unit
		13	2	5SU1 654-6KK13	5SU1 654-7KK13	011	0.260	1 unit
16		2	5SU1 654-6KK16	5SU1 654-7KK16	011	0.260	1 unit	
20		2	5SU1 654-6KK20	5SU1 654-7KK20	011	0.260	1 unit	
25		2	5SU1 654-6KK25	5SU1 654-7KK25	011	0.260	1 unit	
32		2	5SU1 654-6KK32	5SU1 654-7KK32	011	0.260	1 unit	
40		2	5SU1 654-6KK40	5SU1 654-7KK40	011	0.260	1 unit	

* You can order this quantity or a multiple thereof.

Residual Current Operated Circuit-Breakers Supplementary Components/Accessories for RCBOs

Remote controlled mechanisms for 5SU1

Benefits

- Can be retrofitted individually (see Mounting Concept)
- Mounting with factory-fitted brackets
- Can be mechanically latched and locked
- Further additional components can be attached
- Function switch on the front
- $U_N = 230\text{ V}$, 50 to 60 Hz
- Additional components are identical to those for 5SY miniature circuit-breakers.

Mounting concept

Using this mounting concept, all additional 5ST3 components can be combined with miniature circuit-breakers of the 5SY¹⁾ and 5SP4 series and the 5SU1 RCBO series:

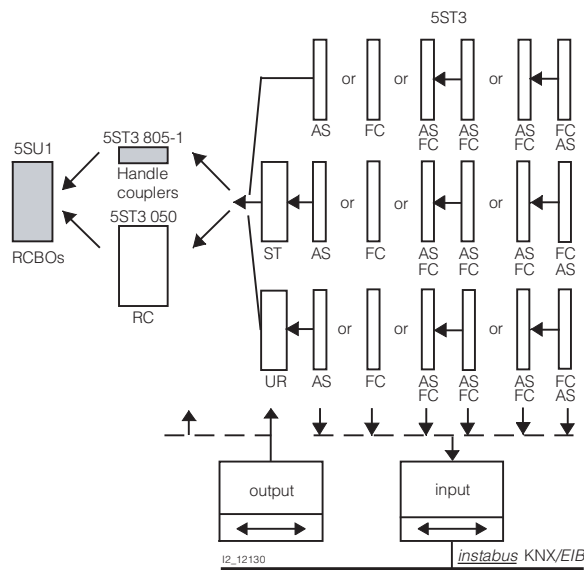

1) Not for 5SY6...-KV

Function

- Remote ON/OFF switching of the RCBO.
- Remote ON switching possible following acknowledgment of fault occurrence
- Manual switching on-site possible
- Remote display of switching status of remote controlled mechanisms and RCBOs.

Selection and ordering data

Rated voltage	MW	Order No.	Price 1 unit	PG	Weight 1 unit	PS*/P. unit
U_n V AC					kg	Unit(s)
230	3.5	5ST3 050		027	0.395	1 unit



Remote-controlled operating mechanisms for 5SU1 RCBO

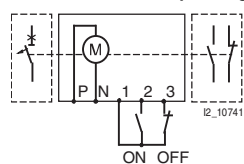

For detailed application information, see Operator's Guide.

Residual Current Operated Circuit-Breakers Supplementary Components/Accessories for RCBOs

Auxiliary circuit switches/fault signal contacts for 5SU1









Benefits

- Can be retrofitted individually (see Mounting Concept)
- Mounting with factory-fitted brackets
- Short-circuit protection with miniature circuit-breakers of characteristic B or C and $I_n = 6$ A or gL 6 A fuses.
- Wide range of applications due to additional version for controlling programmable controllers (PLCs) according to EN 61131-2
- Can be connected to *instabus* KNX *EIB* and AS-Interface bus over binary inputs.

Application

- Indication of the switching state of the RCBO
 - AS: ON/OFF
 - FC: tripped.

Selection and ordering data

Version	MW	Order No.	Price 1 unit	PG	Weight 1 unit kg	PS*/ P. unit Unit(s)
Auxiliary switches (AS) for 5SU1...-KK.. RCBOs¹⁾						
		For small output 1 NO + 1 NC	0.5	5ST3 010 5ST3 013	027 027	0.050 0.050 1 unit 1 unit
		For small output 2 NO		5ST3 011 5ST3 014	027 027	0.050 0.050 1 unit 1 unit
		For small output 2 NC		5ST3 012 5ST3 015	027 027	0.050 0.050 1 unit 1 unit
Fault signal contacts (FC) for 5SU1...-KK.. RCBOs¹⁾						
		1 NO + 1 NC	0.5	5ST3 020	027	0.050 1 unit
		2 NO		5ST3 021	027	0.050 1 unit
		2 NC		5ST3 022	027	0.050 1 unit

1) Also required: 5ST3 805-1 handle coupler.

* You can order this quantity or a multiple thereof.

Siemens LV 1 · 2006

19/99

Residual Current Operated Circuit-Breakers Supplementary Components/Accessories for RCBOs

Shunt trips/undervoltage releases, handle couplers for 5SU1

Benefits

Shunt trips

- Can be retrofitted individually (see Mounting Concept)
- Response limits according to DIN VDE 0660 Part 100, 7.2.1.4
- For voltages:
110 to 415 V AC, 110 V DC
24 to 48 V AC/DC
- Can be connected to *instabus* KNX EIB and AS-Interface bus through binary outputs.

Undervoltage trip units

- Can be retrofitted individually (see Mounting Concept)
- Response limits according to DIN VDE 0660 Part 100, 7.2.1.3
- For voltages:
230 V AC
110 V DC
24 V DC
- Can be connected to *instabus* KNX EIB and AS-Interface bus through binary outputs.

Application



Shunt trips

- Remote tripping of the RCBO.

Undervoltage trip units

- Applicable as remote trip in an EMERGENCY-STOP loop
- Assures disconnection of the control circuit according to EN 60204
- In cases of interrupted or insufficient voltage, the undervoltage release trips the miniature circuit-breaker or prevents it from switching on.

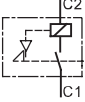
Selection and ordering data

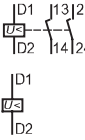
	Rated voltage U_n	MW	Order No.	Price 1 unit	PG	Weight 1 unit kg	PS*/ P. unit Unit(s)
	Shunt trips (ST) for 5SU1...-KK. RCBOs¹⁾						
	110 ... 415 V AC	1	5ST3 030		027	0.098	1 unit
	24 ... 48 V AC/DC	1	5ST3 031		027	0.098	1 unit
	Undervoltage releases (UR) for 5SU1...-KK.. RCBOs¹⁾						
	230 V AC	1	5ST3 040		027	0.115	1 unit
	110 V DC		5ST3 041		027	0.115	1 unit
	24 V DC		5ST3 042		027	0.115	1 unit
	230 V AC	1	5ST3 043		027	0.115	1 unit
	110 V DC		5ST3 044		027	0.115	1 unit
	24 V DC		5ST3 045		027	0.115	1 unit







1) Also required: 5ST3 805-1 handle coupler.

	Order No.	Price 1 unit	PG	Weight 1 unit kg	PS*/ P. unit Unit(s)
	5ST3 805-1		027	0.008	1 set
Handle couplers for additional components					
For mounting the additional components: auxiliary switches, fault signal contacts, shunt trips and undervoltage releases onto 5SU1 ...-KK.. RCBOs, you require a handle coupler. 1 set = 5 units					

Residual Current Operated Circuit-Breakers Supplementary Components/Accessories for RCBOs

Accessories for 5SU1

Accessories

Version	Order No.	Price 1 unit	PG	Weight 1 unit approx. kg	PS*/ P. unit Unit(s)
 <p>Locking devices For 5SU1 ...-..KK.. RCBOs Sealable and lockable 4.5 mm lock hasp diameter</p>	5ST3 801-1		027	0.010	1 unit
 <p>Padlocks For 5ST3 801-1 locking device</p>	5ST3 802		027	0.027	1 unit
<p>Cu busbars 10 mm² For busbar mounting 5SU1 ...-..KK.. RCBOs together Fully insulated</p> <p>2-phase</p> <p>2 x 2-phase 3 x 2-phase 6 x 2-phase</p> <p>2 x (2-phase + AS/FC) 3 x (2-phase + AS/FC) 5 x (2-phase + AS/FC)</p>  <p>Without end caps Length 1016 mm</p> <p>2-phase 2-phase + AS/FC</p>	<p>5ST3 606 5ST3 607 5ST3 608 5ST3 610 5ST3 611 5ST3 612</p> <p>5ST3 735 5ST3 737</p>		027 027 027 027 027 027 027 027	0.016 0.024 0.048 0.020 0.030 0.050 0.290 0.290	1 unit 1 unit 1 unit 1 unit 1 unit 1 unit 1 unit 1 unit
<p>Cu busbars 16 mm² For busbar mounting 5SU1 ...-..KK.. RCBOs together Fully insulated</p> <p>2-phase</p> <p>2 x 2-phase 3 x 2-phase 6 x 2-phase</p> <p>2 x (2-phase + AS/FC) 3 x (2-phase + AS/FC) 5 x (2-phase + AS/FC)</p>  <p>Without end caps Length 1016 mm</p> <p>2-phase 2-phase + AS/FC</p>	<p>5ST3 636 5ST3 637 5ST3 638 5ST3 640 5ST3 641 5ST3 642</p> <p>5ST3 705 5ST3 707</p>		027 027 027 027 027 027 027 027	0.024 0.039 0.076 0.026 0.045 0.084 0.290 0.290	1 unit 1 unit 1 unit 1 unit 1 unit 1 unit 1 unit 1 unit
 <p>End caps For lateral insulation of cut-to-length busbars</p>			027	0.001	1 unit
 <p>Touch protection For free connections, yellow (RAL 1004)</p>	5ST3 655		027	0.003	1 unit

For more busbar versions,
see Accessories for Miniature Circuit-Breakers.

AS: auxiliary circuit switch

FC: fault signal switch

* You can order this quantity or a multiple thereof.

Siemens LV 1 · 2006

19/101

Residual Current Operated Circuit-Breakers

RC Units for Miniature Circuit-Breakers

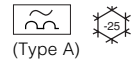

5SM2, product overview

Overview

	Number of poles	Rated current I_n A	Rated residual current $I_{\Delta n}$ mA	MW	Additional components can be retrofitted	 (Type A) ¹⁾
RC units for 5SY4, 5SY6, 5SY7, 5SY8 miniature circuit-breakers²⁾						
Instantaneous tripping Surge current withstand capability > 1 kA	2	0.3 ... 16	10	2	On the MCB	•
	2	0.3 ... 40	30, 300	2	On the MCB	•
		0.3 ... 63	30, 300, 500		On the MCB	•
	3	0.3 ... 40 0.3 ... 63	30, 300 30, 300, 500	3	On the MCB On the MCB	• •
4	0.3 ... 40 0.3 ... 63	30, 300 30, 300, 500	3	On the MCB On the MCB	• •	
[K] Short-time delayed Surge current withstand capability > 3 kA	4	0.3 ... 40 0.3 ... 63	30	3	On the MCB On the MCB	• •
[S] Selective Surge current withstand capability > 5 kA	2	0.3 ... 40 0.3 ... 63	300	2	On the MCB On the MCB	• •
	3	0.3 ... 63	300, 500, 1 000	3	On the MCB	•
	4	0.3 ... 63	300, 500, 1 000	3	On the MCB	•
RC units for 5SP4 miniature circuit-breakers						
Instantaneous tripping, surge current withstand capability > 1 kA	2	80 ... 100	30, 300	3.5	On the MCB	•
	4	80 ... 100	30, 300	5	On the MCB	•
[S] Selective Surge current withstand capability > 5 kA	2	80 ... 100	300	3.5	On the MCB	•
	4	80 ... 100	300, 1 000	5	On the MCB	•

- 1)  = Type A for AC and pulsating DC residual currents
- 2) For RC unit, additional components for 5SY- and 5SP4 miniature circuit-breakers, see also Miniature Circuit-Breakers.

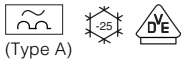

Residual Current Operated Circuit-Breakers

RC Units for Miniature Circuit-Breakers

**5SM2, 0.3 ... 63 A,
for 5SY4, 5SY6, 5SY7, 5SY8**

Benefits





- High application flexibility
- Customers can combine the device characteristics of RC units and miniature circuit-breakers
- Used together with miniature circuit-breakers achieves a combined personnel and line protection

Application

- Personnel and fire protection
 - $I_{\Delta n} \leq 30$ mA: additional protection in case of direct contact
 - $I_{\Delta n} \leq 300$ mA: preventative fire protection in case of ground fault currents

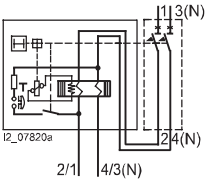
- Product standards: IEC/EN 61009-1 (VDE 0664, Part 20); IEC/EN 61009-2-1 (VDE 0664, Part 21); IEC/EN 61543 (VDE 0664, Part 30)
- Rated voltage for 2, 3 and 4-pole version: 230 to 400 V AC; 50 to 60 Hz; applicable in systems up to: 250/440 V AC
- Can be combined with miniature circuit-breakers of characteristic A, B, C and D
- Definition of surge current withstand capability with current waveform 8/20 μ s according to DIN VDE 0432, Part 2
- **[S]** S type: can be used as upstream group switch for selective tripping contrary to a downstream standard RCCB. Very high surge current withstand capability: > 5 kA
- **[K]** K type: short-time delayed tripping in the case of transient leakage currents. High surge current withstand capability: > 3 kA

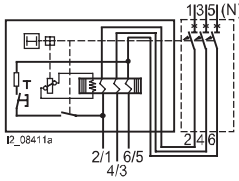
Selection and ordering data

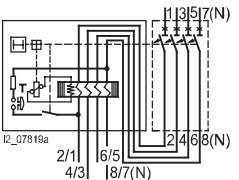
Circuit diagram	Rated residual current $I_{\Delta n}$ mA	Rated current I_n A	MW	Ver- sion	Order No.	Price 1 unit	PG	Weight 1 unit approx. kg	PS*/ P. unit Unit(s)
Instantaneous tripping, surge current withstand capability > 1 kA¹⁾									
 <p>230 ... 400 V AC, 50 ... 60 Hz, 2-pole</p> 	10	0.3 ... 16	2		5SM2 121-6		007	0.180	1 unit
	30	0.3 ... 40	2		5SM2 322-6		007	0.170	1 unit
	300				5SM2 622-6		007	0.170	1 unit
	30	0.3 ... 63			5SM2 325-6		007	0.170	1 unit
	300				5SM2 625-6		007	0.170	1 unit
	500				5SM2 725-6		007	0.170	1 unit
 <p>230 ... 400 V AC, 50 ... 60 Hz, 3-pole</p> 	30	0.3 ... 40	3		5SM2 332-6		007	0.260	1 unit
	300				5SM2 632-6		007	0.260	1 unit
	30	0.3 ... 63			5SM2 335-6		007	0.260	1 unit
	300				5SM2 635-6		007	0.260	1 unit
	500				5SM2 735-6		007	0.260	1 unit
	 <p>230 ... 400 V AC, 50 ... 60 Hz, 4-pole</p> 	30	0.3 ... 40	3		5SM2 342-6		007	0.290
300					5SM2 642-6		007	0.290	1 unit
30		0.3 ... 63			5SM2 345-6		007	0.290	1 unit
300					5SM2 645-6		007	0.290	1 unit
500					5SM2 745-6		007	0.290	1 unit
[K] Short-time delayed, surge current withstand capability > 3 kA¹⁾		30	0.3 ... 40	3	[K]	5SM2 342-6KK01		007	0.350
		0.3 ... 63		[K]	5SM2 345-6KK01		007	0.350	1 unit
[S] Selective, surge current withstand capability > 5 kA¹⁾									
230 ... 400 V AC, 50 ... 60 Hz, 2-pole	300	0.3 ... 40	2	[S]	5SM2 622-8		007	0.170	1 unit
	300	0.3 ... 63		[S]	5SM2 625-8		007	0.170	1 unit
230 ... 400 V AC, 50 ... 60 Hz, 3-pole	300	0.3 ... 63	3	[S]	5SM2 635-8		007	0.260	1 unit
	500			[S]	5SM2 735-8		007	0.260	1 unit
	1 000			[S]	5SM2 835-8		007	0.260	1 unit
230 ... 400 V AC, 50 ... 60 Hz, 4-pole	300	0.3 ... 63	3	[S]	5SM2 645-8		007	0.290	1 unit
	500			[S]	5SM2 745-8		007	0.290	1 unit
	1 000			[S]	5SM2 845-8		007	0.290	1 unit

1) Not for 5SY6 ...-KV.

* You can order this quantity or a multiple thereof.

Residual Current Operated Circuit-Breakers RC Units for Miniature Circuit-Breakers

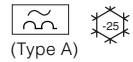

5SM2, 80 ... 100 A, for 5SP4

Benefits



- High application flexibility
- Customers can combine the device characteristics of RC units and miniature circuit-breakers
- Used together with miniature circuit-breakers achieves a combined personnel and line protection
- External remote tripping over Y1/Y2 terminals

Application

- Personnel and fire protection
 - $I_{\Delta n} \leq 30$ mA: additional protection in case of direct contact
 - $I_{\Delta n} \leq 300$ mA: preventative fire protection in case of ground fault currents

- Product standards: IEC/EN 61009-1 (VDE 0664, Part 20); IEC/EN 61009-2-1 (VDE 0664, Part 21); IEC/EN 61543 (VDE 0664, Part 30)
- Rated voltage
 - 2-pole: 125 to 230 V AC; 50 to 60 Hz; can be used in systems up to 125/240 V AC
 - 4-pole: 230 to 400 V AC; 50 to 60 Hz; can be used in systems up to 230/400 V AC
- Can be combined with miniature circuit-breakers, characteristic B and C
- Definition of surge current withstand capability with current waveform 8/20 μ s according to DIN VDE 0432, Part 2
- **S** type: can be used as upstream group switch for selective tripping compared with downstream standard RCCBs. Very high surge current withstand capability: > 5 kA

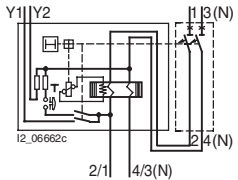
Selection and ordering data

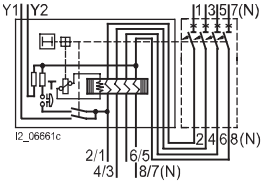
Circuit diagram	Rated residual current $I_{\Delta n}$ mA	Rated current I_n A	MW	Ver- sion	Order No.	Price 1 unit	PG	Weight 1 unit approx. kg	PS*/ P. unit Unit(s)	
Instantaneous tripping, surge current withstand capability > 1 kA										
	125 ... 230 V AC, 50 ... 60 Hz, 2-pole									
		30 300	80 ... 100	3.5		5SM2 327-6 5SM2 627-6		007 007	0.410 0.410	1 unit 1 unit
	230 ... 400 V AC, 50 ... 60 Hz, 4-pole									
		30 300	80 ... 100	5		5SM2 347-6 5SM2 647-6		007 007	0.630 0.630	1 unit 1 unit
S Selective, surge current withstand capability > 5 kA										
	125 ... 230 V AC, 50 ... 60 Hz, 2-pole									
		300	80 ... 100		S	5SM2 627-8		007	0.410	1 unit
	230 ... 400 V AC, 50 ... 60 Hz, 4-pole									
		300 1 000	80 ... 100		S S	5SM2 647-8 5SM2 847-8		007 007	0.630 0.630	1 unit 1 unit

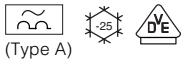

Residual Current Operated Circuit-Breakers RC Socket Outlets

5SM1 and 5SZ9 RCCB protective socket outlets

Overview

	Number of poles	Rated current I_n A	Rated residual current $I_{\Delta n}$ mA	(Type A)
RCCB protective socket outlets				
For mounting onto switch and socket box, equipped with RCCB and 2 socket outlets	2	16	10, 30	•
Molded-plastic enclosures, equipped with RCCB and socket outlet	2	16	10	•
RCCB protective socket outlets for a higher level of protection				
 DELTA profil socket outlets, titanium white	2	16	10, 30	•

= Type A for AC and pulsating DC residual currents

Application

Molded-plastic enclosures, equipped with RCCB and flush-mounting socket outlets or flush-mounting double socket outlets

- Rated voltage: 230 V AC, 50 to 60 Hz
- For electric devices where, in the event of damage, there is a risk of accidental contact with live parts
- For outdoor connection of gardening equipment and socket outlets in workshops or for agricultural purposes
- Degree of protection IP54 (5SZ9).

RCCB protective socket outlets according to VDE 0662, DELTA profil

- Rated voltage: 230 V AC, 50 to 60 Hz
- Childproof socket outlets with integrated RCCB
- For retrofitting in existing installations or for additional protection in children's rooms, bathroom, garage, workshop, kindergarten, schools, etc.
- With VDE mark of conformity according to the DIN VDE 0662 (Stationary Protective Socket Outlet for a Higher Level of Protection, SRCD) draft
- The mode of operation is not dependent on the system voltage
- The protective conductor is monitored but not switched
- Degree of protection IP21
- With screwless terminals 1.5 to 2.5 mm², for copper and aluminum conductors
- For installation in conventional switch and socket boxes, \varnothing 60 mm, for screw connection
- Operable in TN-S system, TN-C system and TT system
- Including frame, single frame, with cutout 48 mm × 48 mm.

Note:
The protective measures according to DIN VDE 0100 must also be observed when RCCB protective socket outlets are used.

Selection and ordering data

	Rated residual current $I_{\Delta n}$ mA	Rated current I_n A	Order No.	Price 1 unit	PG	Weight 1 unit approx. kg	PS*/P. unit Unit(s)
<p>RCCB protective socket outlets according to VDE 0664 for mounting on switch and socket boxes, equipped with residual current operated circuit-breakers and 2 childproof socket outlets</p>	10	16	5SM1 920-5 5SM1 920-8		008	0.500	1 unit
	30					0.500	1 unit
<p>RCCB protective socket outlets according to VDE 0664 in molded-plastic enclosure, equipped with residual-current operated circuit-breaker and flush-mounting socket outlet</p>	10	16	5SZ9 206 5SZ9 216		008	0.760	1 unit
	30					0.760	1 unit

* You can order this quantity or a multiple thereof.

Residual Current Operated Circuit-Breakers RC Socket Outlets

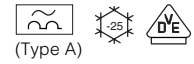

5SM1 and 5SZ9 RCCB protective socket outlets

Rated residual current $I_{\Delta n}$ mA	Rated current I_n A	Order No.	Price 1 unit	PG	Weight 1 unit approx. kg	PS*/ P. unit Unit(s)
--	-----------------------------	-----------	-----------------	----	-----------------------------------	----------------------------



RCCB protective socket outlets according to VDE 0662 for increased protection level (SCHUKO) childproof DELTA profil socket outlets, titanium white

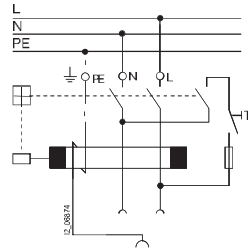

10	16	5SZ9 211 5SZ9 212	008	008	0.160	1 unit
30						

Suitable for mounting on 5TG1 825 surface-mounting enclosures.

For more cutout frames for multiple combinations, see Catalog ET D1, "DELTA Switches and Outlets".

Residual Current Operated Circuit-Breakers Accessories

For all product ranges

Accessories

	Order No.	Price 1 unit	PG	Weight 1 unit approx. kg	PS*/ P. unit Unit(s)
 <p>Terminal covers, gray For surface mounting, degree of protection IP40, sealable, with 35 mm standard mounting rail Up to 2.5 MW Up to 4.5 MW</p>	5SW3 004		008	0.084	1 unit
	5SW3 005		008	0.114	1 unit
 <p>Wall enclosures, gray For flush mounting, degree of protection IP40, with 35 mm standard mounting rail Up to 2.5 MW Up to 4.5 MW</p>	5SW3 006		008	0.126	1 unit
	5SW3 007		008	0.147	1 unit
 <p>Molded-plastic enclosures, gray Surface mounting, IP54, with 35 mm standard mounting rail, sealable, with transparent hinged lid, for 4.5 MW</p>	5SW1 200		008	0.450	1 unit
 <p>Covers Can be assembled as mini distribution board, suitable for all devices, cover parts prepared for side-by-side mounting of conventional label caps, comprising:</p> <ul style="list-style-type: none"> • End plates (for snapping onto standard mounting rail) • Angled profile (approx. 1 m long) • Alternatively flat profile (as a cover between the rows of devices, length approx. 1 m) 	5ST2 134		027	0.022	1 unit
	5ST2 135		027	0.330	1 unit
	5ST2 136		027	0.260	1 unit
 <p>Snap-on terminals For 35 mm standard mounting rail For conductors up to 16 mm² solid or conductors up to 10 mm² stranded Width 0.5 MW</p>	5ST2 112		027	0.008	1 unit
 <p>Fixing parts 4 MW (plastic)</p>	5ST2 201		027	0.012	1 unit
 <p>Inscription labels (white) 15 mm × 9 mm, 3 frames with 44 labels each Any attachment, inscription possible, self-adhesive</p>	5ST2 173		027	0.038	1 set
	<p>Labeling systems The labeling program can be downloaded free of charge from: http://www.siemens.com/beta Recommended labels ELAT-3-747 can be ordered at: Brady GmbH Otto-Hahn-Str. 5-7 63222 Langen Tel: +49 (0)6103/7598-660</p>				1 set

* You can order this quantity or a multiple thereof.

Siemens LV 1 · 2006

19/107

Lightning and Surge Arresters

Introduction

Overview

Lightning arresters – requirement category B, type 1, class I



- 1 and 3-pole
- Rated discharge voltage U_C 255 V AC
- Lightning impulse current 50 ... 100 kA
- Enclosed and unenclosed version

Combination arresters – requirement category B, type 1, class I



- Multipole
- Rated discharge voltage U_C 255 V AC
- Lightning impulse current 25 ... 100 kA
- TN-C, TN-S and TT version
- Optional remote signaling module

Surge arresters, 1-pole – requirement category C, type 2, class II



- Rated discharge voltage U_C 255 ... 385 V AC
- Rated discharge current 15 ... 20 kA
- Version with or without remote display

Surge arresters, multipole – requirement category C, type 2, class II



- Rated discharge voltage U_C 255 ... 335 V AC
- Rated discharge current 15 ... 20 kA
- Version with or without remote display

Surge arresters – requirement category D, type 3, class III



- Modular devices
- Socket outlets and socket outlet adapters
- Combined protection equipment, socket outlet adapters

Accessories



- Male connector for surge arresters
- Interaction limiting phase reactor
- Through-type terminal
- Busbars

Lightning and Surge Arresters



Lightning Arresters

Requirement category B, type 1, class I

Overview

- Supports inclusion of power lines in the lightning protection equipotential bonding
- For protection of low-voltage load systems against overvoltage, even in case of direct lightning strikes
- Max. permissible operational voltage 255 V AC, 50/60 Hz
- Lightning impulse current test, wave-shaped 10/350 μ s
- The enclosed version can prevent ion emissions, as opposed to self-extinguishing measuring spark gaps: this facilitates the mounting of wiring next to other devices in the system
- Supports energy coordination with surge arresters of requirement category C, type 2, class II
- Mounting depth: 58 mm

Selection and ordering data

		Discharge capacity	MW	Order No.	Price 1 unit	PG	Weight 1 unit approx. kg	PS*/ P. unit Unit(s)
Lightning arresters								
	Lightning arresters, 1-pole							
	Unenclosed	75 kA	2	5SD7 311-0		008	0.353	1 unit
	N-PE unenclosed	100 kA	2	5SD7 318-0		008	0.295	1 unit
	Enclosed	50 kA	2	5SD7 311-1		008	0.277	1 unit
	N-PE enclosed	100 kA	2	5SD7 318-1		008	0.261	1 unit
5SD7 318-1								
	Lightning arresters, 3-pole							
	Enclosed	100 kA	4	5SD7 313-1		008	0.579	1 unit
	Lightning arresters with increased follow current discharge capacity, 1-pole							
	Safe breaking of line-follow currents up to 50 kA _{eff} without series fuse							
	Unenclosed	50 kA	2	5SD7 315-0		008	0.353	1 unit
Accessories for 5SD7 311-0, 5SD7 318-0 and 5SD7 315-0 to ensure the required mounting dimensions:								
8HP molded-plastic distribution system in enclosure size 1 and 2, see SIVACON Switchgear, Distribution Systems and Cabinets.								

* You can order this quantity or a multiple thereof.

Siemens LV 1 · 2006

19/109



Lightning and Surge Arresters Combination Arresters

Requirement category B, type 1, class I

Overview

- Combination arresters are surge arresters that meet the basic requirement of requirement category I and II, i.e.:
 - Have a lightning stroke current discharge capacity of 75 kA/100 kA (10/350)
 - Can be energy-coordinated with surge arresters of requirement category B, type 2, class II and C, type 3, class III as well as directly with data terminal equipment of overvoltage category I ($U_n = 230 \text{ V AC}$)
- Protection level < 1.5 kV, corresponding to withstand impulse voltage of overvoltage category I
- Compact unit for all 3-phase systems which is ready for connection
- Connection system: double terminal design supports "V wiring" option
- Multifunction terminal in the outgoing circuit
- Visual operational voltage display
- Remote indication by means of a separate, overvoltage-protected display and remote signaling module
- Overvoltage and atmospheric lightning arrester in a single device
- Perfect "all in one" solution
- Cabled complete device for any distribution system (TT, TN-C and TN-S)
- Easy-to-use device selection thanks to simple description
- Up to 70 % more space saving than conventional solutions
- Simple installation on standard mounting rail
- Mounting depth: 58 mm

Selection and ordering data

	MW	Order No.	Price 1 unit	PG	Weight 1 unit approx. kg	PS*/P. unit Unit(s)
Combination arresters						
	TN-C	6	5SD7 343-0	008	1.070	1 unit
	TN-S	8	5SD7 344-0	008	1.388	1 unit
	TT	8	5SD7 343-1	008	1.402	1 unit
	2P TT	8	5SD7 341-1	008	0.853	1 unit
5SD7 343-1						
	Remote signaling modules					
	The remote signaling module is placed on left-hand side of combination arrester and linked to the existing connecting cables. Contact: 1 CO contact 250 V AC, 0.5 A 250 V DC, 0.1 A 125 V DC, 0.2 A 75 V DC, 0.5 A Contact 11/12: Operating status 11/14: Fault 					
	For 5SD7 343-0, 5SD7 343-1 and 5SD7 344-0 combination arresters With 4 connecting cables	1.5	5SD7 348-3	008	0.146	1 unit
For 5SD7 341-1 combination arresters With 2 connecting cables	1.5	5SD7 348-1	008	0.154	1 unit	

Lightning and Surge Arresters

Surge Arresters

1-pole
Requirement category C, type 2, class II

Overview

- For the protection of low-voltage load system against overvoltage
- High discharge capacity through powerful zinc oxide varistors/spark gaps (N-PE surge arresters)
- High monitoring reliability through isolating arrester disconnecter "Thermo Dynamic Control" with double monitoring
- Fault indication through red marking in inspection window
- Multifunction terminals for conductor and busbar connection
- Simple replacement of surge arrester connectors
- Simple mounting on standard mounting rail with busbars
- Design as for multipole version
- Same connector as for multipole version
- No interaction limiting phase reactor with surge arresters Class III (formerly D)

Selection and ordering data

	MW	Order No.	Price 1 unit	PG	Weight 1 unit approx. kg	PS*/ P. unit Unit(s)
Surge arresters, 1-pole						
Surge arresters						
<ul style="list-style-type: none"> • High monitoring reliability through isolating arrester disconnecter "Thermo Dynamic Control" with double monitoring function • Fault indication through red marking in the inspection window • Multifunction terminal for conductor and busbar connection • 1-pole 						
Rated surge arrester voltage $U_c = 275$ V	1	5SD7 300-2		008	0.130	1 unit
Rated surge arrester voltage $U_c = 385$ V	1	5SD7 300-5		008	0.127	1 unit
Surge arresters with remote display¹⁾						
<ul style="list-style-type: none"> • Same version as 5SD7 300-2, but with additional 3-pole terminal for connection of remote indication • When the monitoring device responds (disconnection of the defective arrester from the line supply as a result of overload), the remote signaling connections are switched through a floating changeover contact. 						
						
Rated surge arrester voltage $U_c = 275$ V	1	5SD7 301-2		008	0.135	1 unit

1) The devices can be coupled to *instabus* KNX EIB and AS-i bus or PROFIBUS through potential-free changeover contacts.

* You can order this quantity or a multiple thereof.





Siemens LV 1 · 2006

19/111

Lightning and Surge Arresters

Surge Arresters

1-pole
Requirement category C, type 2, class II

	MW	Order No.	Price 1 unit	PG	Weight 1 unit approx. kg	PS*/ P. unit Unit(s)
Surge arresters, 1-pole, plug-in						
 5SD7 302-2		Surge arresters, plug-in				
		<ul style="list-style-type: none"> Same version as 5SD7 300-2, but 2-piece, comprising basic element and plugged protective block 1-pole Rated surge arrester voltage $U_c = 275\text{ V}$ 1 5SD7 302-2 008 0.136 1 unit Rated surge arrester voltage $U_c = 335\text{ V}$ 1 5SD7 302-4 008 0.138 1 unit				
 5SD7 303-2		Surge arresters, plug-in with remote display¹⁾				
		<ul style="list-style-type: none"> Same version as 5SD7 302-2, but with additional 3-pole terminal for connection of remote indication When the monitoring device responds (disconnection of the defective arrester from the line supply as a result of overload), the remote signaling connections are switched through a floating changeover contact. 				
						
		Rated surge arrester voltage $U_c = 275\text{ V}$ 1 5SD7 303-2 008 0.150 1 unit Rated surge arrester voltage $U_c = 335\text{ V}$ 1 5SD7 303-4 008 0.285 1 unit Rated surge arrester voltage $U_c = 385\text{ V}$ 1 5SD7 303-5 008 0.140 1 unit				
 		N-PE surge arresters for 3+1 circuitry in the TT network				
		<ul style="list-style-type: none"> Specially for operation in TT system in "3+1 circuit" according to DIN V VDE V 0100-534: 1999-04 between neutral conductor N and PE conductor/equipotential bonding with lightning impulse current (10/350 μs) 12 kA Surge arrester on the basis of spark gaps Multifunction terminal for conductor and busbar connection Rated surge arrester voltage $U_c = 275\text{ V}$ 1 5SD7 308-0 008 0.117 1 unit				

For technical specifications, see Catalog ET B1 T.

1) The devices can be coupled to *instabus* KNX EIB and AS-i bus or PROFIBUS through potential-free changeover contacts.

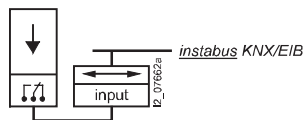

Lightning and Surge Arresters

Surge Arresters

Multipole
Requirement category C, type 2, class II

Overview

The multipole surge arresters are pre-wired complete devices. While 1-pole surge arresters can also generally be used to achieve the same function, the advantages of the multipole surge arresters are considerable cost-savings and a significantly smaller footprint in the distribution board.

The multipole lightning arresters are available for conventional system types, with or without remote indication. These devices are separable and are also available with plug-in protective blocks.

All device models are available for rated surge arrester voltages of 275 V, 335 V and 385 V. The 275 V version is used in the FRG and in Europe (exception: in Austria, the version with a rated surge arrester voltage of 335 V AC is used). The 385 V version is intended for the Asian market.

Designs:

- TN-C, plug-in
- TN-C, plug-in with remote indication
- TN-S, plug-in
- TN-S, plug-in with remote indication
- TT plug-in
- TT plug-in with remote indication

Accessories: Connectors

Versions suitable for multipole surge arresters TN-C/TN-S/TT and 1-pole surge arresters.

The pluggable protective block can be replaced with no need to disconnect the supply voltage or remove the cover plate of the distribution board.

Selection and ordering data

	Surge arrester rated voltage	MW	Order No.	Price 1 unit	PG	Weight 1 unit approx.	PS*/P. unit	
	U_c					kg	Unit(s)	
Surge arresters, multipole, plug-in								
	TN-C	275 V	3	5SD7 323-2		008	0.379	1 unit
		335 V	3	5SD7 323-4		008	0.361	1 unit
		385 V	3	5SD7 323-5		008	0.401	1 unit
	TN-C with remote indication	275 V	3	5SD7 324-2		008	0.369	1 unit
		335 V	3	5SD7 324-4		008	0.328	1 unit
		385 V	3	5SD7 324-5		008	0.404	1 unit
	TN-S	275 V	4	5SD7 325-2		008	0.484	1 unit
		335 V	4	5SD7 325-4		008	0.462	1 unit
		385 V	4	5SD7 325-5		008	0.502	1 unit
TN-S with remote indication	275 V	4	5SD7 326-2		008	0.385	1 unit	
	335 V	4	5SD7 326-4		008	0.472	1 unit	
	385 V	4	5SD7 326-5		008	0.509	1 unit	
TT	275 V	4	5SD7 327-2		008	0.438	1 unit	
	335 V	4	5SD7 327-4		008	0.438	1 unit	
	385 V	4	5SD7 327-5		008	0.472	1 unit	
TT with remote indication	275 V	4	5SD7 328-2		008	0.470	1 unit	
	335 V	4	5SD7 328-4		008	0.462	1 unit	
	385 V	4	5SD7 328-5		008	0.480	1 unit	

* You can order this quantity or a multiple thereof.

Siemens LV 1 · 2006

19/113

Lightning and Surge Arresters

Surge Arresters

Modular installation devices,
requirement category D, type 3, class III



Overview

Surge arresters of requirement category D, type 3, class III are used for protection of data terminal equipment. They represent the third level of the lightning and overvoltage protection concept and, typically, are used at the transition areas for lightning protection zones LPZ 2 to LPZ 3.

Surge arresters of requirement category D are available in the following versions:

- As modular devices for rail-mounting
- As SCHUKO socket outlets and socket outlet adapters
- As combination protective adapters for special applications with additional protection of data lines

Selection and ordering data







	MW	Order No.	Price 1 unit	PG	Weight 1 unit approx. kg	PS*/ P. unit Unit(s)
Surge arresters/modular devices, 2-pole						
 <p>Surge arresters</p> <ul style="list-style-type: none"> • Rated voltage 230 V AC/DC • Rated surge arrester voltage 255 V AC/DC • 2-pole overvoltage protection with monitoring equipment and isolating arrester disconnecter • Floating remote indication contact (NC contact) for fault indication • For protection of 1-phase terminal equipment 	1.5	5SD7 332-0		008	0.110	1 unit
Surge arresters/modular devices, 4-pole						
 <p>Surge arresters</p> <ul style="list-style-type: none"> • Rated voltage 230 V AC/DC • Rated surge arrester voltage 255 V AC/DC • 4-pole overvoltage protection with monitoring equipment and isolating arrester disconnecter • Floating remote indication contact (NC contact) for fault indication • For protection of 1-phase terminal equipment 	3	5SD7 334-0		008	0.208	1 unit

Lightning and Surge Arresters

Surge Arresters

Socket outlets and adapters, combination protection equipment, requirement cat. D, type 3, class III

Selection and ordering data

MW	Order No.	Price 1 unit	PG	Weight 1 unit approx. kg	PS*/P. unit Unit(s)
Surge arresters/socket outlets					
	Siemens (SCHUKO) socket outlets with overvoltage protection 5UB1.../5UH1...¹⁾				
	<ul style="list-style-type: none"> Rated voltage 230 V AC/DC Rated surge arrester voltage 255 V AC/DC 2-pole overvoltage protection with monitoring equipment and isolating arrester disconnecter For protection of 1-phase terminal equipment With labeling field For the DELTA switch-socket outlet range 				
Surge arresters/socket outlet adapters					
	Protective adapters, standard	5SD7 335-0	008	0.159	1 unit
	<ul style="list-style-type: none"> Can be plugged into (SCHUKO) socket outlets Visual function/fault indication Rated voltage 230 V AC/50 Hz Rated current: 16 A Rated discharge current: 2.5 kA 				
	Protective adapters with line filter	5SD7 335-1	008	0.260	1 unit
	<ul style="list-style-type: none"> Can be plugged into (SCHUKO) socket outlets Visual function/fault indication Rated voltage 230 V AC/50 Hz Rated current: 16 A Rated discharge current: 2.5 kA Same as the standard protective adapters with line filter against high-frequency noise voltages 				
Surge arresters/combination protection equipment					
	NTBA/DSL splitter protective adapters	5SD7 335-2	008	0.260	1 unit
	<ul style="list-style-type: none"> Can be plugged into (SCHUKO) socket outlets Visual function/fault indication Rated voltage 230 V AC/50 Hz Rated current: 16 A Rated discharge current: 2.5 kA Connection: <ul style="list-style-type: none"> - 3 m connecting cable with TAE/F connector - TAE/F socket 				
	ISDN protective adapters	5SD7 335-3	008	0.278	1 unit
	<ul style="list-style-type: none"> Can be plugged into (SCHUKO) socket outlets Visual function/fault indication Rated voltage 230 V AC/50 Hz Rated current: 16 A Rated discharge current: 2.5 kA Connection: <ul style="list-style-type: none"> - 3 m connecting cable with RJ45 connector - RJ45 socket 				
	LAN protective adapters	5SD7 335-4	008	0.175	1 unit
	<ul style="list-style-type: none"> Can be plugged into (SCHUKO) socket outlets Visual function/fault indication Rated voltage 230 V AC/50 Hz Rated current: 16 A Rated discharge current: 2.5 kA Connection: <ul style="list-style-type: none"> - RJ45 socket, shielded - RJ45 socket, shielded 				
	TV/RADIO protective adapters	5SD7 335-5	008	0.227	1 unit
	<ul style="list-style-type: none"> Can be plugged into (SCHUKO) socket outlets Visual function/fault indication Rated voltage 230 V AC/50 Hz Rated current: 16 A Rated discharge current: 2.5 kA Connection: <ul style="list-style-type: none"> - 75 Ω IEC socket - 75 Ω IEC socket 				









1) For prices and more information, see Catalog ET D1, "DELTA Switches and Outlets".

* You can order this quantity or a multiple thereof.

Lightning and Surge Arresters

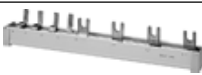
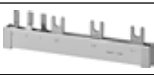
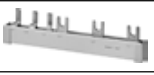
Accessories

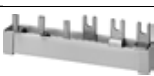
Selection and ordering data

	MW	Order No.	Price 1 unit	PG	Weight 1 unit approx. kg	PS*/ P. unit Unit(s)
Through-type terminals						
<ul style="list-style-type: none"> For simple wiring in the different circuit versions (see Catalog ET B1) 						
	1	5SD7 360-0		008	0.121	1 unit
Male connectors for surge arresters						
<ul style="list-style-type: none"> Male connectors can be used for both 1-pole and multipole surge arresters 						
 5SD7 392-2	1	5SD7 392-2		008	0.049	1 unit
	Male connector for L-N surge arrester Rated surge arrester voltage $U_C = 275$ V					
	1	5SD7 392-4		008	0.049	1 unit
	Male connectors for L-N surge arresters Rated surge arrester voltage $U_C = 335$ V					
1	5SD7 392-5		008	0.049	1 unit	
Male connectors for L-N surge arresters Rated surge arrester voltage $U_C = 385$ V						
1	5SD7 398-0		008	0.035	1 unit	
Male connector for N-PE surge arrester (TT system)						
Busbars						
Busbars for lightning arresters						
		8-pole, 1-phase	5SD7 361-1	008	0.038	1 unit
Busbars for surge arresters						
		4-pole, 1-phase	5SD7 361-0	008	0.020	1 unit
Busbars for combination arresters						
		TN-S/TT and 4-pole residual current protective devices (5SM1 and 5SM3)	5SD7 084	008	0.133	1 unit
		TN-S/TT and 4-pole miniature circuit-breakers (5SY)	5SD7 085	008	0.143	1 unit
		TN-C and 3-pole residual current protective devices (5SM1 and 5SM3)	5SD7 086	008	0.079	1 unit
		TN-C and 3-pole miniature circuit-breakers (5SY)	5SD7 087	008	0.084	1 unit
		TN-S/TT and 4-pole miniature circuit-breakers (5SY)	5SD7 088	008	0.104	1 unit
		TN-C and 3-pole miniature circuit-breakers (5SY)	5SD7 090	008	0.064	1 unit
Interaction limiting phase reactors						
 5SD7 390-0	<ul style="list-style-type: none"> For the energetic coordination of lightning and surge arresters in the event of a lightning impulse current of 10/350 μs The concentrated inductance replaces the otherwise necessary cable length for decoupling lightning and surge arrester Mounting depth: 58 mm Rated voltage: 500 V, 50 Hz ... 60 Hz Inductance: 15 μH \pm 20 % 					
	2	5SD7 390-0		008	0.355	1 unit
	4	5SD7 391-0		008	0.680	1 unit
	Rated current: 35 A Rated current: 63 A					

Power Supply Devices

5TE6 8 socket outlets

Overview

Socket outlets for mounting on standard mounting rails according to DIN 50022 have since become the standard in modern switch-gear/distribution boards. The 5TE6 8 socket outlets can be used without lids for 55 mm mounting depth, and with covers for 70 mm mounting depth. The lids can be retrofitted on all devices. The lid can be opened to an angle of 180 degrees.







By pulling on the hinges, the lids stay open, which facilitates plugging in.

To make mounting easier, the touch-protected terminals L, N and PE are located on the side of the socket outlet.

The 5TE6 8 socket outlets are available in the following country versions (in compliance with the pertinent standards):

- For Germany (VDE)
- For Belgium/France (CEE 7)
- For Italy (DEI) and
- For USA (UL)

Selection and ordering data

	U_e	I_e	Conductor cross-section	MW	Order No.	Price 1 unit	PG	Weight 1 unit approx.	PS*/P. unit
	V AC	A	mm ²					kg	Unit(s)
	VDE socket outlets according to DIN VDE 0620-1				5TE6 800		027	0.102	1 unit
	• Without lid	250	16	6					
	VDE socket outlets according to DIN VDE 0620-1				5TE6 801		027	0.109	1 unit
	• With hinged lid	250	16	6					
	Socket outlets according to CEI 23-50				5TE6 802		027	0.111	1 unit
	• With hinged lid	250	16	6					
	Socket outlets according to CEE 7 Standard sheet V				5TE6 803		027	0.104	1 unit
	• Without lid, with grounding pin	250	16	6					
	Socket outlets according to UL 498				5TE6 804		027	0.099	1 unit
	• Without lid, mounting depth 55 mm	125	15	6					
	Hinged lids for 5TE6 80. socket outlets				5TE9 120		027	0.018	1 unit

* You can order this quantity or a multiple thereof.







Siemens LV 1 · 2006







19/117

Measuring Devices

Introduction

Overview

Instruments	Application	Standards	Usage		
			Non-residential buildings	Residential buildings	Industry
 <p>Time and pulse counters</p> <ul style="list-style-type: none"> • 7KT5 80 and 7KT5 82 time counters • 7KT5 81 and 7KT5 83 pulse counters 	Monitoring of operating hours and starting operations of devices or plants	IEC 60255-6, EN 60255-6 (VDE 0435 T 301) UL 94	•	•	•
 <p>Time counters for front mounting</p> <p>7KT5 5 and 7KT5 6</p>	Monitoring of operating hours of devices or plants	IEC 60255-6, EN 60255-6 (VDE 0435 T 301)	•	•	•
 <p>Analog measuring devices</p> <p>7KT1 0</p>	For measuring voltages and currents, for monitoring input and output currents or device currents	IEC 60051-2, EN 60051-2	•		•
 <p>Digital measuring devices</p> <p>7KT1 1</p>	For measuring voltages and currents, for monitoring input and output currents or device currents	DIN 43751-1, DIN 43751-2	•		•
 <p>Multimeters</p> <p>7KT1 30</p>	For the display and assessment of 23 electrical measured values in switchgear, incoming supplies and outgoing feeders	IEC 60051-2, EN 60051-2 IEC 61010-1, EN 61010-1 (VDE 0411 T 1)	•		•
 <p>Multicounters</p> <p>7KT1 31, 7KT1 34, 7KT1 35</p>	For the display and assessment of 35 electrical measured values and consumption values in switchgear, incoming supplies and outgoing feeders	IEC 60051-2, EN 60051-2 IEC 61010-1, EN 61010-1 (VDE 0411 T 1) IEC 62053-21, EN 62053-21 (VDE 0418 T 3-21)	•		•

Instruments	Application	Standards	Usage		
			Non-residential buildings	Residential buildings	Industry
 <p>E-counters, 1-phase 7KT1 14</p>	For the measurement of kWh in 1-phase systems, e.g. in industrial plants, offices and apartments in apartment houses	IEC 62053-11, EN 62053-11 (VDE 0418 T 3-11) IEC 62053-21, EN 62053-21 (VDE 0418 T 3-21)	•	•	•
 <p>E-counters, 3-phase 7KT1 50, 7KT1 51, 7KT1 52</p>	For the measurement of kWh in 1- and 3-phase systems, e.g. in industrial plants, offices and apartments in apartment houses	IEC 61010-1, EN 61010-1 (VDE 0411 T 1) IEC 62053-11, EN 62053-11 (VDE 0418 T 3-11) IEC 62053-21, EN 62053-21 (VDE 0418 T 3-21)	•	•	•
 <p>E-counters, 3-phase, <i>instabus</i> KNX EIB 7KT1 16</p>	With <i>instabus</i> KNX EIB interface, for the measurement of kWh in 1- and 3-phase systems in industrial plants, offices and apartments in apartment houses	IEC 61036 EN 61036 (VDE 0418 T7)	•		•
 <p>LAN couplers 7KT1 390</p>	Worldwide data communication with measuring devices using LAN/Internet	IEEE 802	•		•
 <p>Measuring selector switches 7KT9 0</p>	For switching over the phases for voltmeters and ammeters		•		•
 <p>Current transformers 7KT1 2</p>	For non-contact measuring of primary currents of a 3-phase system	IEC 60044-1, EN 60044-1 (VDE 0414 T 44-1)	•		•

Definitions

- I_e = Rated operational current
- U_e = Rated operational voltage
- I_c = Rated control supply current
- U_c = Rated control supply voltage
- P_s = Rated operational power
- 1 MW = Modular width 18 mm



Measuring Devices

7KT5 8 time and pulse counters

Overview

The counters are designed for installation in switching, control and distribution boards and can be snapped onto 35 mm standard mounting rails according to EN 60715.

Selection and ordering data

U_c	Frequency	MW	Order No.	Price 1 unit	PG	Weight 1 unit approx.	PS*/ P. unit	
V	Hz					kg	Unit(s)	
 7KT5 801	Time counters							
	Mechanical register							
	Display 00000.00 h							
	Without resetting							
	12 ... 24 DC	--	2	7KT5 801		027	0.095	1 unit
	24 AC	50		7KT5 802		027	0.095	1 unit
	115 AC			7KT5 803		027	0.095	1 unit
	230 AC			7KT5 804		027	0.095	1 unit
	115 AC	60		7KT5 806		027	0.095	1 unit
	230 AC			7KT5 807		027	0.095	1 unit
 7KT5 823	Pulse counters							
	Mechanical register							
	Display 0000000 \square \square							
	Without resetting							
	10 ... 24 DC	--	2	7KT5 811		027	0.095	1 unit
	24 AC	50/60		7KT5 812		027	0.095	1 unit
	230 AC			7KT5 814		027	0.095	1 unit
	Electronic time counters							
	LCD 000000.0 h							
	Without resetting							
12 ... 150 DC, 24 ... 240 AC	50/60	2	7KT5 821		027	0.080	1 unit	
With electrical resetting								
12 ... 150 DC, 24 ... 240 AC	50/60		7KT5 822		027	0.080	1 unit	
With electrical and mechanical resetting								
12 ... 150 DC, 24 ... 240 AC	50/60		7KT5 823		027	0.080	1 unit	
Electronic pulse counters								
LCD display 0000000 \square \square								
With electrical and mechanical resetting								
10 ... 150 DC, 24 ... 240 AC	50/60	2	7KT5 833		027	0.080	1 unit	

7KT5 time counters for front mounting



Application

Areas of application are time and pulse recording for switchgear cabinets, control and mechanical engineering, e.g. boilers, machine tools or compressors.

Preventive maintenance

Time counters provide support when planning preventive maintenance. In-time and regular maintenance is the best protection against unexpected shutdowns and ensures high plant availability.

Selection and ordering data

U_c	Frequency	MW	Order No.	Price 1 unit	PG	Weight 1 unit approx.	PS*/P. unit
V	Hz					kg	Unit(s)
Time counters							
Mechanical register, display 00000.00 h For front mounting, front frame 48 mm x 48 mm							
	10 ... 80 DC	--	7KT5 500		027	0.045	1 unit
	24 AC	50	7KT5 505		027	0.045	1 unit
	115 AC		7KT5 501		027	0.045	1 unit
	230 AC		7KT5 502		027	0.045	1 unit
	115 AC	60	7KT5 503		027	0.045	1 unit
	230 AC		7KT5 504		027	0.045	1 unit
7KT5 500							
For front mounting, front frame 72 mm x 72 mm With narrow frame according to DIN 43700							
	10 ... 50 DC	--	7KT5 600		027	0.120	1 unit
	115 AC	50	7KT5 601		027	0.120	1 unit
	230 AC		7KT5 602		027	0.120	1 unit
	115 AC	60	7KT5 603		027	0.120	1 unit
	230 AC		7KT5 604		027	0.120	1 unit
7KT5 600							
Covers for 7KT5 5 time counters							
55 mm x 55 mm			7KT9 020		027	0.015	5 units
Sealing rings for 7KT9 020 covers							
IP 43-installation in switchboards with smooth surfaces (1 set = 5 units)			7KT9 000		027	0.020	1 set
Terminal covers for 7KT5 6 time counters							
Degree of protection IP20			7KT9 021		027	0.010	5 units

* You can order this quantity or a multiple thereof.

Measuring Devices

7KT1 0 analog measuring devices 7KT1 1 digital measuring devices



Overview

These devices for measuring voltages and currents can be used for monitoring input and output currents or device currents. They are suitable for direct connection in a 1-phase network or, together with a measuring selector switch, for 3-phase networks. Depending on the transformer, the ammeter for transformer connection can be fitted with interchangeable scales of 60, 100, 250, 400, 600 and 1000 A AC.

Main features of the devices are:

- Extensive scale
- Continuous overload up to 20 %

Selection and ordering data



	U_c	U_{meas}	I_{meas}	MW	Order No.	Price 1 unit	PG	Weight 1 unit approx. kg	PS*/ P. unit Unit(s)	
	V AC	V AC	A AC							
	Analog voltmeters									
		500		4	7KT1 000		027	0.105	1 unit	
	Analog ammeters for direct connection									
				25 40 60	4	7KT1 010 7KT1 011 7KT1 012		027 027 027	0.110 0.125 0.135	1 unit 1 unit 1 unit
	Analog ammeters for transformer connection with AC scale 0 up to 150 A									
			0 ... 150/5	4	7KT1 020		027	0.105	1 unit	
	Changeable scales for 7KT1 020 ammeters									
	Easy on-site replacement									
				60		7KT9 001		027	0.005	1 unit
				100		7KT9 002		027	0.005	1 unit
				250		7KT9 004		027	0.005	1 unit
				400		7KT9 005		027	0.005	1 unit
				600		7KT9 006		027	0.005	1 unit
			1000		7KT9 007		027	0.005	1 unit	

Overview

These devices for measuring voltages and currents can be used for monitoring input and output currents or device currents. They are suitable for direct connection in a 1-phase network or, together with a measuring selector switch, for 3-phase networks.

The measuring ranges of the ammeter are set at the device with a coding switch.

Selection and ordering data

	U_c	U_{meas}	I_{meas}	MW	Order No.	Price 1 unit	PG	Weight 1 unit approx. kg	PS*/ P. unit Unit(s)
	V AC	V AC	A AC						
	Digital voltmeters								
		230	600		2	7KT1 110		027	0.190
	Digital ammeters for direct and transformer connection								
		230		0 ... 20 Trans- former/5	2	7KT1 120		027	0.200

Overview



- All required measuring values of an installation clearly visible at a glance
- Innovative matrix selection of assignment and selection of measurement data of the display registers
- For direct connection of 63 A or for transformer /1A or /5A
- For transformer primary current of 10 A to 5000 A. Input is in 5 A increments
- Size, 11 mm high, attractive green 7-segment display for measured values
- Clearly recognizable orange text display of units assigned to the displays where the measured value appears
- Representation of measured values on 5 triple 7-segment displays and an auxiliary 7-segment display for input of primary current
- Detection of connection errors (phase transposition)
- With error detection in case of incorrect connection
- Measuring accuracy for voltage, current and output: $\pm 2\% \pm 1$ digit

Application

Extremely compact multifunction display for direct or transformer connection in a 3-phase network with wye-delta measurement for the display of up to 31 different electrical measured values in a switch-gear, incoming or outgoing feeders.

A special feature is the analysis of the different loads on the phases. Phase displacement, unsymmetrical or unbalanced loads can cause partial overloads. In this case, the multimeter offers a range of different options to combine measured values and assess them.

Selection and ordering data

	U_c	I_e	U_e	MW	Order No.	Price 1 unit	PG	Weight 1 unit approx. kg	PS*/P. unit Unit(s)
	V AC	A AC	V AC						
 <p>7KT1 300</p>	Multimeters For the display of 23 electrical values, of which 5 values can be continuously displayed. For 3 phases, 3/4-wire connection For direct connection								
	230	63	3 x 230/400	6	7KT1 300		027	0.400	1 unit
	For transformer connection of 10 ... 5000 A, adjustable in 5 A increments Secondary current, optionally 1 A or 5 A								
 <p>7KT1 302</p>	230	/1 or /5	3 x 230/400	6	7KT1 301		027	0.380	1 unit
	For front mounting 96 mm x 96 mm For transformer connection of 10 to 5000 A, adjustable in 5 A increments Secondary current, optionally 1 A or 5 A								
	230	/1 or /5	3 x 230/400		7KT1 302		027	0.378	1 unit

* You can order this quantity or a multiple thereof.

Measuring Devices

7KT1 3 multimeters

Overview

- All required measuring values of an installation clearly visible at a glance
- Innovative matrix selection of assignment and selection of measurement data of the display registers
- For direct connection of 63 A or for transformer /1A or /5A
- For transformer primary current of 10 A to 5000 A. Input is in 5 A increments
- Size, 11 mm high, attractive green 7-segment display for measured values
- Clearly recognizable orange text display of units assigned to the displays where the measured value appears
- Display of measured values on 4 three-fold 7-segment displays and a 7-fold 7-segment display
- Selection of display for active, reactive and apparent energy value, 3 or 7-digit
- Detection of connection errors (phase transposition)
- Accuracy class 2 according to IEC 62053-21, -23
- Versions with LAN and MS user interface
- Versions with PROFIBUS DP V1 interface



Application

Extremely compact multifunction display for direct or transformer connection in a 3-phase network with star-delta measurement for the display of up to 35 different electrical measured values in a switch-gear, incoming or outgoing feeders.

A special feature is the analysis of the different loads on the phases. Phase displacement, unsymmetrical or unbalanced loads can cause partial overloads. In this case, the multimeter offers a range of different options to combine measured values and assess them.

You will find information on LAN operation and the MS Excel user interface under LAN Couplers.

Selection and ordering data

	U_c	I_e	U_e	MW	Order No.	Price 1 unit	PG	Weight 1 unit approx. kg	PS*/ P. unit Unit(s)
	V AC	A AC	V AC						
Multimeters									
For the display of 38 electrical values, of which 5 or 6 values can be continuously displayed. For 3 phases, 3/4-wire connection									
With S0 interface									
For direct connection									
 7KT1 310	230	63	3 × 230/400	6	7KT1 310		027	0.420	1 unit
	230	/1 or /5	3 × 230/400	6	7KT1 311		027	0.410	1 unit
For transformer connection of 10 ... 5000 A, adjustable in 5 A increments, secondary current optionally 1 or 5 A, for front mounting 96 mm × 96 mm									
 7KT1 312	230	/1 or /5	3 × 230/400		7KT1 312		027	0.410	1 unit
	With LAN interface for connection to LAN couplers								
For direct connection									
	230	63	3 × 230/400	6	7KT1 340		027	0.420	1 unit
	230	/1 or /5	3 × 230/400	6	7KT1 341		027	0.420	1 unit
For transformer connection of 10 ... 5000 A, adjustable in 5 A increments, secondary current optionally 1 or 5 A, for front mounting 96 mm × 96 mm									
	230	/1 or /5	3 × 230/400		7KT1 342		027	0.430	1 unit
	With PROFIBUS DP								
For direct connection									
	230	63	3 × 230/400	6	7KT1 350		027	0.420	1 unit
	230	/1 or /5	3 × 230/400	6	7KT1 351		027	0.420	1 unit
For transformer connection of 10 ... 5000 A, adjustable in 5 A increments, secondary current optionally 1 or 5 A, for front mounting 96 mm × 96 mm									
	230	/1 or /5	3 × 230/400		7KT1 352		027	0.430	1 unit

7KT1 14 E-counters, 1-phase

Overview

Features

- Accuracy class 2 according to IEC 62053-11
- With drum-type register 4 × 1.2 mm
- Short-circuit resistant pulse output

Application

E-counters are used to measure kWh in 1-phase systems, e.g. in industrial plants, offices and apartments in apartment houses

Selection and ordering data

U_c	I_e	U_e	MW	Order No.	Price 1 unit	PG	Weight 1 unit approx.	PS*/P. unit
V AC	A AC	V AC					kg	Unit(s)
E-counters for active energy								
With drum-type register 4 × 12 mm, with S0 interface, for 1-phase operation								
Direct connection, single rate								
230	63	230	2	7KT1 140		027	0.400	1 unit
Direct connection, double rate								
230	63	230	2	7KT1 141		027	0.400	1 unit



7KT1 140

* You can order this quantity or a multiple thereof.

Measuring Devices

7KT1 5 E-counters, 3-phase

Overview

Features

- 1- or 3-phase measurement for 3- or 4-wire connection and center-tap calculation for 3-wire connection
- For direct connection 63 A or for transformer /5A
- For transformer primary current of 10 A to 5000 A. Input is in 5 A increments

- 7-fold 7-segment display for energy values and additional function indication
- Detection of connection errors (phase transposition)
- Versions with LAN interface and MS Excel user interface
- Accuracy class 2 according to IEC 61036

Application

E-counters are used to measure kWh in 1- and 3-phase systems, e.g. in industrial plants, offices and apartments in apartment houses.

Selection and ordering data

U_c	I_e	U_e	MW	Order No.	Price 1 unit	PG	Weight 1 unit approx. kg	PS*/P. unit Unit(s)
V AC	A AC	V AC						
E-counters for active energy								
With S0 interface, for 3 phases, 3/4-wire connection								
For direct connection, single rate								
230	63	3 × 230/400	6	7KT1 500		027	0.400	1 unit
For transformer connection, single rate								
230	Transformer /5	3 × 230/400	6	7KT1 501		027	0.390	1 unit
For direct connection, double rate								
230	63	3 × 230/400	6	7KT1 510		027	0.400	1 unit
For transformer connection, double rate								
230	Transformer /5	3 × 230/400	6	7KT1 511		027	0.396	1 unit
E-counters for active and reactive energy								
With S0 interface, for 3 phases, 3/4-wire connection								
For direct connection, single rate								
230	63	3 × 230/400	6	7KT1 502		027	0.400	1 unit
For transformer connection, single rate								
230	Transformer /5	3 × 230/400	6	7KT1 503		027	0.396	1 unit
For direct connection, double rate								
230	63	3 × 230/400	6	7KT1 512		027	0.396	1 unit
For transformer connection, double rate								
230	Transformer /5	3 × 230/400	6	7KT1 513		027	0.396	1 unit
E-counters for active and reactive energy								
With LAN for connection to LAN coupler, for 3 phases, 3/4-wire connection								
For direct connection, double rate								
230	63	3 × 230/400	6	7KT1 520		027	0.410	1 unit
For transformer connection, double rate								
230	Transformer /5	3 × 230/400	6	7KT1 521		027	0.400	1 unit

Measuring Devices

7KT1 16 E-counters, 3-phase, instabus KNX EIB

Overview

E-counter with LCD display

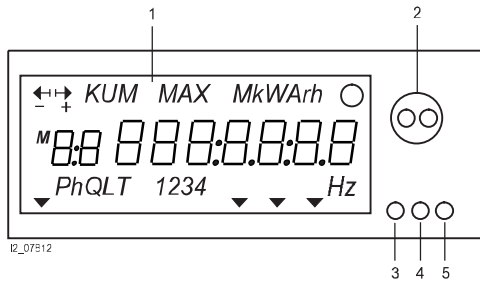

12_07512

- 1 Large-size 7-digit LCD 8 × 4 mm
- 2 IR readout interface for mounting the readout measuring head
- 3 Display pushbutton
- 4 IR test output LED (10 IMP/W)
- 5 Sealable Set/Reset pushbutton

Benefits

- PTB-approved
- Accuracy class 2
- LCD
- Short-circuit resistant pulse output
- With network analysis functions and direct cost display

Application

For the measurement of kWh in 1- and 3-phase systems, e.g. in industrial plants, offices and apartments in apartment houses. The versions with LCD display are used as network analysis devices for consumption analysis and minimization of operating costs in industrial plants and office buildings.

Selection and ordering data

Display	I_e	U_e	MW	Order No.	Price 1 unit	PG	Weight 1 unit approx.	PS*/P. unit
	A AC	V AC					kg	Unit(s)
E-counters for 3/4-wire connection, with LCD, with IR interface for double rate Direct connection, with 2 S0 pulse outputs and <i>instabus</i> KNX EIB interface								
 7KT1 162	Active and reactive energy	10(63)	3 × 230/400	6	7KT1 162	027	0.450	1 unit
	Transformer connection, with 2 S0 pulse outputs and <i>instabus</i> KNX EIB interface							
	Active and reactive energy	Transformers/5(6)	3 × 230/400	6	7KT1 165	027	0.390	1 unit

Accessories

	Order No.	Price 1 unit	PG	Weight 1 unit approx.	PS*/P. unit
				kg	Unit(s)
 IR measuring heads for 7KT1 16... For reading out the data according to IEC 61107 With 9-pole COM connector and readout software	7KT9 030		027	0.170	1 unit

* You can order this quantity or a multiple thereof.

Siemens LV 1 · 2006

19/127

Measuring Devices

7KT1 390 LAN couplers 7KT9 0 measuring selector switches

Overview

- Worldwide communication with measuring devices
- TCP/IP data protocol
- One LAN coupler for 10 devices
- Plug-and-play technology
- Microsoft Excel user interface (MS Excel)
- Limit value signals can be set for all measured values
- Limit violations are signaled with time information
- Analysis of 35 measured values with the 7KT1 340 or 7KT1 341 multiconverters

Application

LAN servers are the data communication link between a PC and a group of up to 10 measuring devices (multiconverters or E-counters) with one LAN interface. The LAN coupler can be linked either directly to a PC or in a company-specific LAN.

All devices are switched in parallel with a shielded 2-wire LAN interface line. The hardware interface between the devices and the LAN coupler supports plug-and-play technology.

Selection and ordering data

	U_c	MW	Order No.	Price 1 unit	PG	Weight 1 unit approx. kg	PS*/P. unit Unit(s)
	V AC						
							
LAN couplers							
For connection of 10 devices with LAN interface, with software for installation and startup routines and Microsoft Excel and tables for operating, setting limit values and monitoring							
	230	4	7KT1 390		027	0.300	1 unit



Overview

- According to EN 60947-3
- Rated insulation voltage 660 V.

Application

For switching over the phases for voltmeters and ammeters.

Selection and ordering data

	U_e	I_e	Conductor cross-sections	MW	Order No.	Price 1 unit	PG	Weight 1 unit approx. kg	PS*/P. unit Unit(s)
	V AC	A	Up to mm ²						
									
Voltmeter selector switches									
	400	12	6	3	7KT9 010		027	0.110	1 unit
									
Ammeter selector switches for transformer operation									
	400	12	6	3	7KT9 011		027	0.110	1 unit

Measuring Devices

7KT1 2 current transformers

Overview

- 3-phase current transformer set
- Accuracy class 1 according to EN 60044-1
- Straight-through transformer for conductors with a diameter of up to 13 mm, e.g. H07V-R with 50 mm² conductor cross-section
- Primary rated current 60 A, 100 A and 150 A
- Transformer ratio 60/5 A, 100/5 A and 150/5 A

Application

Straight-through transformer set in modular distribution board design according to DIN 43880 for installation in distribution boards. It is possible to route the measuring leads straight through the transformer and vertically to the standard mounting rail according to EN 60715.

With this type of construction, the current transformer is suitable for supply systems or outgoing conductors in connection with the installation of a 5TE8 switch or a 5TE1 disconnecter as the primary connecting leads do not have to be interrupted.

Note:

Current transformers must not be operated with open terminals as this may cause dangerous high voltages, which may result in personal injuries and property damage. It also exposes the transformer to thermal overload.

Selection and ordering data

	U_e	I_{sec}	Measuring range	MW	Order No.	Price 1 unit	PG	Weight 1 unit approx.	PS*/P. unit
	V AC	A	A AC					kg	Unit(s)
 <p>7KT1 200</p>	720	5	3 × 60	6	7KT1 200		027	0.460	1 unit
			3 × 100		7KT1 201				1 unit
			3 × 150		7KT1 202				1 unit

* You can order this quantity or a multiple thereof.

Measuring Devices

Notes



20/2	Glossary
20/6	Training
20/7	Ordering notes
20/11	Further documentation
20/12	Standards and approvals
20/27	Quality management
20/28	Siemens contacts
20/29	Online services
20/30	Customer support
20/31	Software licenses
20/32	Subject index
20/38	Order number index
20/44	Fax order
20/45	Terms and conditions of sale and delivery Export regulations
20/51	PDF-CD ROM Catalog LV 1 · 2006 Technical information LV 1 T · 2006

Appendix

Glossary

Requirements for circuit-breakers for motor protection

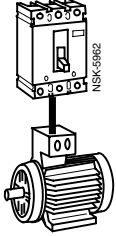

- Inrush immunity:
 - Response threshold of the short-circuit release up to $11 \times I_n$ or
 - Inrush current buffering due to tripping delay (approx. 10 ms to 20 ms)
- Temperature compensation
- Phase-failure sensitivity
- Adjustable trip class for matching the start-up response of the motor
- Thermal memory (repeated attempts at starting heat the motor)
- Overload release according to IEC 60947-4-1:
 - **Must not trip at 1.05 times load within two hours**
 - **Must trip at 1.2 times load within two hours** (at 1.15 times load with 2-phase loads).

Circuit-breakers for motor protection

Switching

- Motor operating currents
- Short-circuit currents that flow in this load feeder.

When circuit-breakers are used with an adjustable time lag class, they can be matched to almost any motor starting current.

Circuit-breakers for starter combinations

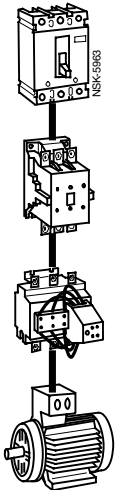

These circuit-breakers are only designed for short-circuit-protection of series-connected equipment and loads, they do not feature overload releases. The short-circuit release is adjustable.

In this case, overload protection must be implemented elsewhere. This can be a simple bi-metal relay or a convenient electronic motor control unit (SIMOCODE) between the load contactor and the load. In the event of a fault, it is then extremely easy to distinguish between an overload (checkback signal of the bi-metal relay) or short-circuit (acknowledgement signal from the circuit-breaker).

If a circuit-breaker with overload protection is chosen instead, the acknowledgement signals from the devices cannot always be clearly distinguished.

For information on the correct assignment of contactors, overload relays and circuit-breakers, please refer to the manual "Fuseless assembly of load feeders", Order No. E20002-A580-P302-V2 or the relevant tables in the Technical Information LV 1 T.

Non-automatic circuit-breakers

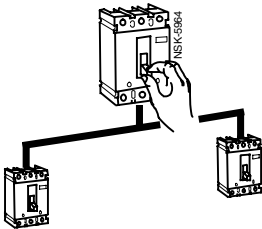

This type of circuit-breaker is used in applications in which different load circuits must be decoupled or connected together. They do not feature overload releases. The short-circuit release is not adjustable.

Current-limiting circuit-breakers



This symbol shows the form of the short-circuit current after the circuit-breaker. Because the let-through current of the circuit-breaker is lower than the maximum value of the short-circuit current (dotted line) they are known as current-limiting circuit-breakers.

The load on the series-connected devices, cables and wires is therefore significantly reduced (see the current limiting characteristic).

Requirements for circuit-breakers for system protection



- Compliance with IEC 60947-1 and IEC 60947-2 standards:
 - **Must not trip at 1.05 time** load **within two** hours
 - **Must trip at 1.3 time** load **within two** hours.
- Usual adjustment range:
 - It is usually not necessary to adjust the overload release;
 - Response threshold of the short-circuit release 1.25 to $10 \times I_n$ or
- A selectivity analysis is necessary.

Circuit-breaker for system protection with permanently set values

They have a permanently set overload release and a permanently set short-circuit release.

Current-limiting.

Example:

Circuit-breaker in outgoing feeder to subdistribution boards or switchboards.

Circuit-breakers for system protection with some permanently set values



They have a permanently set overload release and an adjustable short-circuit release.

Current-limiting.

Example:

Circuit-breaker in outgoing feeder to subdistribution boards or switchboards with special requirements for short-circuit releases.

Circuit-breakers for system protection with adjustable values



They have an adjustable overload release and an adjustable short-circuit release.

Current-limiting.

Example:

For direct protection of non-motor loads.

Appendix

Glossary

Circuit-breakers for system protection with adjustable values and short-time delayed release

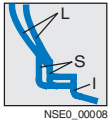

The meaning of the symbols are as follows:

- L: Inverse-time delayed overload release or thermal overload release.
 - If the actual current rises above the value of set operational current (I_r), the circuit-breaker will trip within a certain time.
 - The time of the tripping operation is dependent on the current level.
 - The higher the current, the shorter the tripping delay.
- S: Short-time delayed short-circuit release.
 - The level of short-circuit current (I_{sd}) can be adjusted flexibly.
 - The short-circuit current that flows through the circuit-breaker excites the tripping mechanism (electromagnetic or solid-state).
 - The tripping operation is delayed for the set time (t_{sd}).
 - This means that time-selective grading can be implemented for the circuit-breakers.
- I: Instantaneous short-circuit release.
 - The short-circuit current that flows through the circuit-breaker excites the tripping mechanism (electromagnetic or solid-state).
 - The tripping operation is not delayed.

The value for the I-release (I_i) should be larger than the value for the S-release. In the case of the S-release, if the time (t_{sd}) is set to zero, the S-release responds in the same manner as the I-release, i.e. the tripping operation can be instantaneous, if required.

Example: Circuit-breaker in power distribution with total selectivity.

Circuit-breakers for motor protection with permanently set time lag class



They have an adjustable overload release, a permanently set short-circuit release and a permanently set time lag class.

Current-limiting.

Example:

For protecting motors in this starting class.

Circuit-breakers for motor protection with adjustable time lag class



They have an adjustable overload release, a permanently set short-circuit release and an adjustable time lag class.

Current-limiting.

With phase-failure sensitivity.

Example:

For the protection of motors of differing starting classes (one standard circuit-breaker for all motors), or for AC loads in hazardous areas (phase-failure sensitivity).

Circuit-breakers for starter combinations



They have an adjustable short-circuit release but no overload release.

Current-limiting.

Example:

In applications where a bi-metal relay is connected in series and a separate indication is required for short-circuits (from starter switch) and overloads (from bi-metal relay).

Non-automatic circuit-breakers, current-limiting



MCCB:

They have a permanently set short-circuit release but no overload release (VL160X to VL1600).

The let-through current is limited.

Example:

For disconnecting different load circuits.

Non-automatic circuit-breakers



ACB:

They have neither electronic trip units nor short-circuit releases (3W.).

Non current-limiting.

Example:

For disconnecting different load circuits.

Appendix

Training

Training is decisive for your success

SITRAIN® - the Siemens Training for Automation and Industrial Solutions - provides you with comprehensive support when solving your tasks.

Training by the market leader in automation, plant installation and support permits you to make your decisions with certainty and full command. Especially where the optimum and efficient use of products and plants are concerned. You can eliminate deficiencies in existing plants, and exclude expensive faulty planning right from the beginning.

All in all, this represent an enormous gain for your company: shortened startup times, optimized plant components, faster troubleshooting, reduced down times. In other words, increased profits and lower costs.



Top trainers

Our trainers know their topics in practice, and possess comprehensive didactic experience. Course developers have a direct wire to product development, and directly pass on their knowledge to the trainers.

Practical experience

The practical experience of our trainers makes it possible for them to pass on theoretical matter in a plausible manner. But since it is known that all theory is drab, we attach great importance to practical exercises which can comprise up to half of the course time. You can therefore immediately implement your new knowledge in practice. We train you on state-of-the-art methodically/didactically designed training equipment. You feel absolutely certain when trained in this manner.

Wide variety

With a total of approx. 300 local attendance courses, we train the complete range of A&D products and a large portion of the system solutions from I&S. Telecourses, teach-yourself software and seminars presented on the Web supplement our classical range of courses.

Close to our customers

The distance is short. You can find us approx. 60 times in Germany, and worldwide in 62 countries. You wish to have individual training instead of one of our 300 courses? No problem: we will provide a program tailored exactly to your personal requirements. Training can be carried out in our Training Centers or at your company.

The right mixture: Blended Learning

Blended learning is understood to be the combination of various training media and sequences. For example, a local attendance course in a Training Center can be optimally supplemented by a teach-yourself program as preparation or follow-up. Furthermore, SITRAIN utilizes supported online training for live instruction on the Internet at agreed times.

The right mixture is the solution. Therefore blended learning can convey complex topics well, and train networked thinking. Additional effect: reduced travelling costs and periods of absence through training sequences independent of location and time.

The international training portal

<http://www.siemens.com/sitrain>

All training facilities at a glance: search in the worldwide range of courses at leisure, call up all course dates online, utilize the daily updated display of vacant course spaces - and register directly.

Customer comments on Sitrain

"... the good course documents, competence and flexibility convinced me."

[Manfred Riek from Festo Systemtechnik, responsible for planning the basic and further training of project engineers]

"... represents effective training, constructive dialogs, and solutions which provide great help."

[Günter Niedermaier, electrical design manager at AMT, Aalen]

Contact

Visit us on the Internet at:

<http://www.siemens.com/sitrain>

or let us advise you personally. You can request our latest training catalog from:

Course office, Infoline Germany:
Tel.: +49 (0)1805 / 23 56 11 (0.12 €/Min)
Fax: +49 (0)1805 / 23 56 12

Logistics**General**

With regard to delivery service, communications and environmental protection, our logistics service ensures "quality from the moment of ordering right through to delivery". By designing our infrastructure according to customer requirements and implementing electronic order processing, we have successfully optimized our logistics processes.

We are proud of our personal consulting service, on-time deliveries and 1-day transport within Germany.

To achieve this, we supply the preferred types marked with ► ex warehouse.

We regard the DIN-ISO-9001 certification and consistent quality checks as an integral part of our services.

Electronic order processing is fast, cost-efficient and error-free. Please contact us if you want to benefit from these advantages.

Packing, packing units

The packaging in which our equipment is dispatched provides protection against dust and mechanical damage during transport, thus ensuring that you receive our products in a perfect state.

We select our packaging for maximum environmental compatibility and reusability (e.g. crumpled paper instead of polystyrene chips for protection during transport in packages up to 32 kg) and, in particular, with a view to reducing waste.

With our multi-unit packaging, we offer you specific types of packaging that are both kind to the environment and tailored to your requirements:

Your advantages at a glance:

- Lower order costs.
- Cost savings through uniform-type packaging: low/no disposal costs.
- Reduced time and cost thanks to short unpacking times.
- "Just-in-time" delivery directly to the production line helps reduce stock: cost savings through reduction of storage area.
- Fast assembly thanks to supply in sets.
- Standard Euro boxes - corresponding to the Euro pallet modular system - suitable for most conveyor systems.
- Active contribution to environmental protection.

Unless stated otherwise in the "Selection and ordering data" of this catalog, our products are supplied individually packed.

For small parts/accessories, we offer you economical packing units as standard packs containing more than one item, e.g. 5, 10, 50 or 100 units. It is essential that whole number multiples of these quantities be ordered to ensure satisfactory quality of the products and problem-free order processing.

The products are delivered in a neutral, white carton. The label includes warning notices, the CE mark, the open arrow recycling symbol, and product description information in English and German. In addition to the Order No. (MLFB) and the number of items in the packing, the Instr. Order No. is also specified for the operating instructions. It can be obtained from your local Siemens representative (you will find a list of your local Siemens representatives at <http://www.siemens.com/automation/partner>).

The device order nos. of most devices can also be acquired through the EAN barcode to simplify ordering and storage logistics. The order numbers are assigned electronically to the EAN code in the master data of low-voltage controls.

Appendix

Ordering notes

Multi-unit and reusable packs

The devices listed in the table on page 20/9 can be ordered in multi-unit or reusable packs (further models on request).

If ordering multi-unit or reusable packs for the first time, please first consult your local Siemens representative with regard to pack type, quantity, delivery time and the precise order designation.

For both pack types, the quantity of devices ordered (per Order No.) must be divisible by the pack quantity. If this is not the case, the electronic order processing system rounds up to the next integer multiple of packs.

Multi-unit packaging



Products in a quantity sufficient to fill a multi-unit pack: 1/2 (W96) and 1/4 (W97) ENK

As standard, multi-unit packs contain uniform-type, unpacked individual products (1 device type) in an appropriately sized carton made of recyclable cardboard. The products of the SIRIUS range can be ordered in units of 1/1, 1/2, 1/4 and 1/8 standard Euro boxes (ENK).

When ordering products in multi-unit packs, the Order No. of the product concerned must be supplemented with "**-Z**" and, in addition, the order code **X90**, or for products from the SIRIUS range, the order code **W9**.

Example:
3RT 10 24-1AB00-Z W96
+ quantity: 48

Reusable packaging (uniform type)



Standard reusable packs contain uniform-type, non-packed individual products (1 device type) in a reusable standard Euro box (ENK) made of durable molded plastic with foam inserts for protection during transport.

The standard Euro box (ENK) also serves as transport packaging. Reusable transport containers (MTB) on request.

For products packed in reusable packaging, the Order No. must be supplemented with "**-Z**" and the order code **X95**.

Example:
3RT 10 24-1AB00-Z X95
+ quantity: 96

Ordering notes

Set deliveries (reusable, different devices)

On request, we also deliver order-related packs of larger quantities of different unpacked devices in standard Euro boxes.

Please contact your Siemens representative (you will find Siemens representatives at <http://www.siemens.com/automation/partner>) to clarify the delivery details or conditions for set supply and other delivery types such as container delivery/return, either in standard Euro boxes or reusable transport containers. They will work out what best suits your individual requirements.

Packaging dimensions

Packaging	Length mm	Height mm	Width mm
ENK	598	220	396
W95	576	192	380
W96	380	187	290
W97	290	187	190
W98	290	98	190

Multi-unit and reusable packaging, quantity in units, supplied in indivisible pack quantities

Instruments	Reusable	Multi-unit			
	X95 (1/1 ENK)	W95 (1/1 ENK)	W96 (1/2 ENK)	W97 (1/4 ENK)	W98 (1/8 ENK)
Contactors, sizes S00-S2					
3RT10 1...A/B..1/2	144	144	90	42	20
3RT10 2...A..0	96	96	48	24	12
3RT10 2...A..4	52	52	24	12	6
3RT10 2...B..0	66	66	35	17	10
3RT10 3...A..0/4	30	30	15	-	-
3RT10 3...B..0	27	27	15	-	-
3RT10 3...B..4	24	24	15	-	-
Snap-on auxiliary contact blocks, size S00:					
3RH19 11-1F./GA/HA..	600	600	280	140	70
Auxiliary contactors, size S00					
3RH11 ..-A/B..0	144	144	90	42	20
Motor starter protectors, sizes S00-S2:					
3RV10 11-....0	96	96	48	24	12
3RV10 21-....0	61	61	29	14	-
3RV10 31-....0	24	24	12	-	-
Thermally delayed overload relays, sizes S00-S2:					
3RU11 16-..B0	128	128	64	32	16
3RU11 26-..B0	88	88	45	22	14
3RU11 36-..B0	36	36	18	-	-
Fuseless load feeders up to 12 A, size S00:					
3RA11 10-..A..-1A0	52	52	26	12	6
3RA11 10-..A..-1BB4	52	52	26	12	6
Solid-state timing relays:					
3RP15 05-...30, 3RP15 60-..S.30	137	137	67	27	16
3RP15 1/2/4/5-..A.30	192	192	96	48	24
3RP15 2/4-..B.30	137	137	67	27	16
3RP15 3-..A.30	137	137	67	27	16
3RP15 74-..N.30	192	192	96	48	24

Instruments	Reusable	Multi-unit
	X95	X90
3SB pushbuttons and indicator lights		
Complete units and actuators (except EMERGENCY-STOP and key-operated switches)	-	50
Complete units and actuators (except EMERGENCY-STOP and key-operated switches)	-	20
Contact blocks	-	150
Holder	-	100
Support, blanking plug	-	50
3SE position switches		
3SE2 1..-1E..	81	-
3SE2 200-.C, -.XC, -.XN	540	-
3SE2 200-.D	440	-
3SE2 200-.E	420	-
3SE2 200-.G, -.U, -.XG	144	-
3SE2 200-.L, -.M	360	-
3SE2 210-.C	300	-
3SE2 210-.D	270	-
Safety combinations		
3TK28, 3TK29	23	-

Instruments	Reusable
	X95
Inductive proximity switches BERO	
3RG40/3RG41 1.-0...,-1...	80
3RG40/3RG41 1.-2...,-3...,-4...,-7...	200
3RG40/3RG41 2.-0...,-1...	80
3RG40/3RG41 2.-2...,-3...,-4...,-7...	200

Appendix

Ordering notes

Ag and Cu surcharges

Surcharges for copper (Cu) and silver (Ag) will be added to the prices of certain products. The amount of the surcharge depends on the percentage taken from the current list price.

Calculation of the surcharges is governed by the official Ag quotation for refined silver and the applicable Cu-DEL quotation on the date of receipt of order or of call-off.

You will find a current table with the percentages according to products on the Internet at (in German only):
<http://www.siemens.com/lowvoltage/zuschlagsfaktoren>.

The prices for products in chapters 10 and 11 of the catalog include the price of copper calculated on the basis of a list price of € 150/100 kg.

If the copper rate exceeds this price, a surcharge will be made on the basis of the current copper price in the month preceding the date of invoice.

Orders for special designs

For ordering products that differ from the versions listed in the catalog, the order number specified in the catalog must be supplemented with "-Z"; the required features must be specified by means of the alphanumeric order codes or in plain text.

Small orders

When small orders are placed, the costs associated with order processing are greater than the order value. We recommend therefore that you combine several small orders. Where this is not possible, we unfortunately find it necessary to charge a processing supplement of € 20.-- to cover our costs for order processing and invoicing for all orders with a net goods value of less than € 250.--.

Further documentation

Overview

You will find all the latest information material, such as brochures, catalogs, manuals and operating instructions on low-voltage, controls and distribution on the Internet at:

<http://www.siemens.com/lowvoltage/info>

Here you can order your copy of the available documentation or download it in common file formats (PDF, ZIP).



We also provide further support for SIRIUS - SENTRON - SIVACON



Brochures, catalogs and CDs offer fast and more in-depth information

We regard product support as just as important as the products and systems themselves. Visit our Support site on the Internet for a comprehensive range of material on SIRIUS, SENTRON and SIVACON, such as

- Catalogs available to order free of charge
- Operating instructions and manuals for direct download
- Online registration for seminars and events
- Up-to-date answers to your queries and problems
- Software upgrades and updates for fast download
- Telephone assistance in more than 190 countries
- Photos and graphics for external use

and much, much more - all conveniently and easily accessible

Appendix

Standards and approvals

Overview

Verification certificates and characteristic curves

To find the latest overview of the certificates available for our low-voltage controls and distribution products, as well as other technical documentation, please visit our Internet site at:

<http://www.siemens.com/lowvoltage/support>

Document Title	Product	Document ID
USA/Canada UL-ULSTED / Report, E31519 Vol.10 Sec.1 [208 x 3], english	for products: 3PH432, 3PH436, 3PH418 3-2A, 3PH418 4-40A-21	80730208
USA/Canada UL-ULSTED / Report, E14312 Vol.1 Sec.3 [358 x 3], english	for products: 3PF20, 3PF21, 3PF23, 3PF29	85702006
USA/Canada UL-ULSTED / Report, E44883 Vol.2 Sec.17 [83 x 3], english	for products: 3PH11, 3PH13, 3PH14, 3PH12, 3PH16	17818772
USA/Canada UL-ULSTED / Report, E44883 Vol.12 Sec.1 [29 x 3], english	for products: 3PH11-1, 3PH11-2, 3PH11-2	11762000
USA/Canada UL-ULSTED / Report, E44883 Vol.12 Sec.3 [35 x 3], english	for products: 3PH121-1, 3PH121-2	8247372
USA/Canada UL-ULSTED / Report, E31519 Vol.11 Sec.2 [261 x 3], english	for products: 3RT115, 3RT121, 3RT181, 3RT171	82702004

Product support: Approvals / Certificates

Document Title	Product	Document ID
Tapping Characteristics, 4NE060005 37 [30 x 3], german	for products: 3PH1216 / 8 - 25 A, 3PH1046 / 13 - 60 A	86742002
Tapping Characteristics, 4NE060005 05 [31 x 3], german	for products: 3PH1216 / 8 - 25 A, 3PH1046 / 13 - 60 A	11824618
Tapping Characteristics, 4NE060005 09 [32 x 3], german	for products: 3PH1216 / 8 - 25 A, 3PH1046 / 13 - 60 A	86742002
Tapping Characteristics, 4NE060005 04 [35 x 3], german	for products: 3PH1216 / 8 - 25 A, 3PH1046 / 13 - 60 A	11824618
Tapping Characteristics, 4NE060005 02 [38 x 3], german	for products: 3PH1216 / 8 - 25 A, 3PH1046 / 13 - 60 A	86742002
Tapping Characteristics, 4NE060005 01 [39 x 3], german	for products: 3PH1216 / 8 - 25 A, 3PH1046 / 13 - 60 A	11824618

Product support: Characteristic curves

IEC	EN	DIN VDE	
IEC 60947-1	EN 60947-1	–	Low-voltage controlgear and switchgear: General requirements
IEC 60947-2	EN 60947-2	–	• Circuit-breakers
IEC 60947-3	EN 60947-3	–	• Load-break switches, disconnectors, switch disconnectors and fuse-combination units
IEC 60947-4-1	EN 60947-4-1	–	• Contactors and motor starters: Electromechanical contactors and motor starters:
IEC 60947-4-2	EN 60947-4-2	–	• Contactors and motor starters: Semiconductor motor controllers and starters
IEC 60947-4-3	EN 60947-4-3	–	• AC semiconductor controllers and contactors for loads other than motors
IEC 60947-5-1	EN 60947-5-1	–	• Control circuit devices and switching elements: Electromechanical control circuit devices
IEC 60947-5-2	EN 60947-5-2	–	• Control circuit devices and switching elements: Proximity switches
IEC 60947-5-3	EN 60947-5-3	–	• Proximity switches (specific behavior under fault conditions)
IEC 60947-5-5	EN 60947-5-5	–	• EMERGENCY-STOP devices with mechanical latching
IEC 60947-5-6	EN 60947-5-6	–	• DC interface for proximity switches and switching amplifier (NAMUR)
IEC 60947-5-7	EN 60947-5-7	–	• Proximity switch with analog output
IEC 60947-6-1	EN 60947-6-1	–	• Multifunctional controlgear and switchgear: Automatic transfer switches
IEC 60947-6-2	EN 60947-6-2	–	• Multifunctional controlgear and switchgear: Control and protection switchgear (CPS)
IEC 60947-7-1	EN 60947-7-1	–	• Ancillary equipment: Terminal blocks for copper conductors
IEC 60947-7-2	EN 60947-7-2	–	• Ancillary equipment: PE conductor terminal blocks for copper conductors
IEC 60947-7-3	EN 60947-7-3	–	• Ancillary equipment: Safety requirements for terminal blocks
IEC 60947-8	EN 60947-8	0660 - 302	• Tripping units for the integrated thermal protection (PTC) of rotating electric machines
IEC 62026-2	EN 50295	–	• Actuator-Sensor Interface (AS-i)
IEC 60269-1	EN 60269-1	–	Low-voltage fuses: General requirements
IEC 60269-4	EN 60269-4	–	Low-voltage fuses: Supplementary requirements for fuse links for protecting semiconductor components
IEC 60050-441	–	–	International dictionary / switchgear and / or switching devices and fuses
IEC 60439-1	EN 60439-1	–	Low-voltage switchgear and controlgear assemblies: Type-tested and partially type-tested assemblies
–	EN 60747-5-1	–	Optocouplers for safe electrical isolation: Requirements, tests
–	EN 50247	0660 - 514	Protection against electric shock: Location of actuators near live parts
–	EN 61140	0140 - 1	Protection against dangerous shock currents: Basic requirements for safe isolation in electrical equipment
IEC 60664-1	EN 60664-1	0110-1	Insulation coordination for electrical equipment in low-voltage systems; Principles, requirements and tests
IEC 60204-1	EN 60204-1	–	Electrical equipment of machines: General requirements
–	EN 50178	–	Equipment of electrical power installations with electronic equipment
–	EN 60079-14	–	Electrical apparatus in potentially explosive atmospheres
–	EN 60079-2	–	Electrical apparatus for potentially explosive atmospheres
–	EN 61810-1	–	Electrical relays without a fixed time response
IEC 61812-1	EN 61812-1	–	Electrical relays, specified-time relays
IEC 60999-1	EN 60999-1	–	Connecting materials: Safety requirements for screw terminals and screwless terminals for copper electrical conductors
IEC 61558-1	EN 61558-1	–	Safety of transformers, power supply units and similar:
IEC 61558-2-1	EN 61558-2-1	–	Particular requirements for line transformers for general use
IEC 61558-2-2	EN 61558-2-2	–	Particular requirements for control-power transformers
IEC 61558-2-4	EN 6158-2-4	–	Particular requirements for isolating transformers for general use
IEC 61558-2-6	EN 61558-2-6	–	Particular requirements for safety isolating transformers for general use
IEC 60726	EN 60076-11	0532-76-11	Power transformers
–	–	0552	Specifications for variable transformers with moving contacts perpendicular to the coiling direction
IEC 61000-4-1	EN 61000-4-1	–	Electromagnetic compatibility (EMC); Part 4: Testing and measuring techniques; Main Section 1: Overview of measuring techniques for interference immunity; Basic EMC standard
IEC 61000-6-3	EN 61000-6-3	–	Electromagnetic compatibility (EMC); Basic technical standard for emitted interference in residential and commercial environments as well as in light industry
IEC 61000-6-4	EN 61000-6-4	–	Electromagnetic compatibility (EMC); Basic technical standard for emitted interference in industrial environments
IEC 60044-1	EN 60044-1	0414 44-1	Instrument transformers: Current transformers
Other specifications			
UL 506			Special transformers
UL 508			Industrial controlling equipment, motor starters
UL 489			Molded case circuit-breakers, molded case switches, and circuit-breaker enclosures
UL 1561			General-purpose and power dry-type transformers
UL 1604			Devices for operation in hazardous areas
UL 1059			Terminal blocks
UL 486E			Internal wiring points for aluminum and / or copper
CSA C22.2 No. 66			Specialty transformers
CSA C22.2 No. 14			Industrial control equipment
CSA C22.2 No. 5			Molded case circuit breakers
ASME A17.5 / B 44.1			Elevator and escalator electrical equipment
JIS C 8201-4-1			Low-voltage switchgear and controlgear; Contactors and motor-starters

Appendix

Standards and approvals

Approval requirements valid in different countries

Siemens low-voltage switchgear and controlgear are designed, manufactured and tested according to the relevant German standards (DIN and VDE), ICE publications and European standards (EN) as well as CSA and UL standards. The standards assigned to the individual switchgear and controlgear components are stated in the relevant parts of this catalog.

As far as is economically viable, the requirements of the various regulations valid in other countries are also taken into account in the design of the equipment.

In some European countries and in North America (see table below), an approval is required for certain low-voltage switchgear and controlgear components. Depending on the market requirements, these components have been submitted for approval to the authorized testing institutes.



In some cases, CSA for Canada and UL for the USA only approve special switchgear designs. Such special types are listed separately from the standard types in the individual parts of this catalog.

For this equipment, partial limitations of the maximum permissible voltages, currents and ratings can be imposed, or special approval and, in some cases, special identification is required.

For use on board ship, the specifications of the marine classification societies must be observed (see table below). In some cases, they require type tests of the components to be approved.

The present state of approval is shown in the "Overview of approved equipment" tables on pages page 20/18 to page 20/26

Testing bodies, approval identification and approval requirements

Country	Canada ¹⁾	USA ¹⁾	China
Government-appointed or private, officially recognized testing bodies	CSA UL (USA)	UL	CQC
Approval symbol			
Approval requirements	+	+	+
Remarks	UL and CSA are authorized to grant approvals according to Canadian or US regulations. Please Note: these approvals are frequently not recognized and additional approval often has to be obtained from the national testing authority.		

For further details on UL and CSA see page 20/17.

1) For guide numbers and file numbers for approvals, please visit <http://www.siemens.com/automation/support> and select "Product Support".

Marine classification societies

Country	Germany	United Kingdom	France	Norway	CIS	Italy	Poland	USA
Name	Germanischer Lloyd	Lloyds Register of Shipping	Bureau Veritas	Det Norske Veritas	Russian Maritime Register of Shipping	Registro Italiano Navale	Polski Rejestr Statków	American Bureau of Shipping
Codes	GL	LRS	BV	DNV	RMRS	RINA	PRS	ABS

CE mark of conformity

Manufacturers of products which fall within the subject area to which EU directives apply must identify their products, instruction manuals or packaging with a CE mark of conformity.

The CE mark of conformity confirms that a product fulfills the appropriate basic requirements of all pertinent directives. The mark of conformity is a mandatory requirement for putting products into circulation throughout the EU.

All the products in this catalog are in conformance with the EU directives and bear the CE mark of conformity.

- Low-voltage directive (NS 73/23/EU)
- EMC directive (EMC 89/336/EU)

ALPHA/LOVAG

The Low Voltage Controls and Distribution Division of Siemens AG is a member of the "Gesellschaft zur Prüfung und Zertifizierung von Niederspannungsgeräten e.V. ALPHA" (Society for Testing and Certification of Low-Voltage Equipment), Frankfurt am Main.

The responsibility of manufacturers and the high quality of products are promoted by ALPHA by means of supportive procedural guidelines for testing equipment according to the currently valid standards.

Providing specific conditions are fulfilled, ALPHA can also issue officially recognized product certificates if required. As a member of LOVAG, ALPHA is also working towards obtaining international recognition for declarations of conformity and certificates.

LOVAG (Low-Voltage Agreement Group) is a body comprising international specialists from certification bodies and industry who are working together to create a standardized European certificate.

List of LOVAG members

ALPHA	Germany
ASEFA	France
ACAIE	Italy
CEBEC	Belgium
Intertek Semko AB	Sweden
APPLUS	Spain



Accident prevention

Test certificates and approvals from the BIA (German statutory industrial accident insurance institution in Bonn) and from SUVA (Swiss institute for accident prevention) are available for some devices in safety control systems. For details, see the respective product descriptions.

Appendix

Standards and approvals

Ex protection certificates for SIRIUS controls

Motor protection devices that protect a motor installed in a potentially explosive atmosphere against overloading must comply with certain special requirements. These requirements are laid down in the following standards:

- EN 60947-1
- EN 60079-14
- EN 60947-4-1
- EN 60079-0
- EN 60079-7

Certification

July 1, 2003 saw the dawning of a new era in the field of explosion protection. Since this date, only those devices and protection systems that have been certified for operation in potentially explosive atmospheres according to directive 94/9/EU can be brought into circulation within the European Union.

Only those motor protection devices that have been constructed according to the above-mentioned standards and which have a conformity declaration from the manufacturer based on a prototype test certificate may be brought into circulation within the member states of the EU.

The quality management system of the manufacturer is also subjected to certain requirements and a "QM certificate" must be obtained for the manufacturer from a recognized authority.

Certification of the QM system

A certificate of approval for quality assurance production has been issued by EXAM¹⁾ with the EXAM¹⁾ number 02 ATEX ZQS/EM, according to Directive 94/9/EU.

This certificate is valid for equipment groups I and II and categories M2 and 2: Safety and control devices for electrical equipment.

Certificates

For the 3RV, 3RU, 3RB, 3UF5 and 3RN motor protection devices, the corresponding conformity declarations and prototype test certificates for Category 2G, and to some extent 2D, are available and can be supplied on request.

Identifying markings

All equipment must be marked in accordance with the ATEX guideline. The ATEX identification code contains the equipment group, the approved environment, the number of the certification authority and other technical data that was determined from the type test.

1) EXAM

The certification authority of the "EXAM BGG EXAM BGG Prüf und Zertifizierungsstelle" numbered as authority number 0158 in accordance with Article 9 of Directive 94/9/EU of the European Parliament dated March 23, 1994, certifies that Siemens Amberg and Cham maintains a quality system for production that satisfies Appendix IV of this Directive.

Certificate of the AS-International Association for AS-Interface products

AS-Interface products are tested and certified by the AS-International Association. The products have been tested in an approved test laboratory according to testing guidelines.

Special specifications for the USA and Canada

In the USA and Canada, for machine tools and processing machines in particular, supply lines are laid using rubber insulated conductors enclosed in heavy-duty steel piping similar to that used for gas or water pipe systems.

The tubing system must be completely watertight and electrically conductive (especially sleeving and elbows). Since the tubing system can also be grounded, the cable entries of enclosed units equipped with heavy-gauge or metric threads must be fitted with metal adapters between these threads and the tube thread. The necessary adapters are specified for the switchgear as accessories; they should be ordered separately unless otherwise specified.











Low-voltage switchgear and controlgear for auxiliary circuits (e.g. contactor relays, command and signaling devices and control switches/auxiliary contacts in general) are generally only

approved by CSA and UL for "**Heavy Duty**" or "**Standard Duty**" and are identified either with these specifications in addition to the maximum permissible voltage or by using an abbreviation.

The abbreviations are harmonized with IEC 60947-5-1 Appendix 1 Table A1 and correspond to the stated utilization categories.

For various switching devices detailed in the catalog, a note has been included to the effect that, above a certain voltage, the control switches/auxiliary contacts can only be used if they have the same polarity. This means that the input terminals can only be connected to the same pole of the control voltage, e.g. "600 V AC above 300 V AC same polarity".

Different features of UL approvals (for USA and Canada)

Recognized component	Listed product
UL issues yellow "Guide cards" with a Guide No. and a File No.	UL issues white "Guide cards" with a Guide No. and a File No.
Devices are identified on the rating plate using the "UL recognition mark": USA:   US Canada:   US	Devices are identified using the "UL listing mark" on the rating plate e.g. USA:  LISTED 165 C Canada:  LISTED 165 C IND. CONT. EQ. IND. CONT. EQ. (165 C stands for: Siemens, A & D CD Division, Amberg plant)
Devices are approved as modules for "factory wiring", i.e.: as devices for installation in control systems, which are selected, installed, wired and tested entirely by trained personnel in factories, workshops or elsewhere, according to the conditions of use .	Devices are approved for "field wiring", i.e.: <ul style="list-style-type: none"> As devices for installation in control systems, which are completely wired by trained personnel in factories, workshops or elsewhere. As single devices for sale in retail outlets in the USA/Canada.
If devices are  or  approved as "listed products", they are also approved as "recognized components" and allowed to be marked  or  .	

For further details on UL and CSA see Pagepage 20/14.

Special specifications for Russia, Australia and China

GOST approval for Russia



AR46

A GOST approval is required for all products that are to be sold in Russia. The GOST mark has been obligatory on the packaging of all devices since mid-1998.

All devices delivered to any part of the Russian Federation must have this customs certification.

C-Tick licensing for Australia



The C-Tick license is required for marketing Siemens components in Australia. Electronic devices must provide proof of EMC clearance in Australia, similar to the CE mark of conformity laid down by the EMC directive applicable in the EU and bear the "C-Tick" mark. These requirements have been in force since October 1, 1999.

CCC approval



A003617

Since August 1, 2003, CCC approval is required for all products that are marketed in China.

Appendix

Standards and approvals

Overview

Equipment	Type	Approvals				Marine classifications								
		Canada (2)	USA (1)	1)	China	Germany	United Kingdom	France	Norway	CIS	Italy	Poland	USA	
		Ⓢ	Ⓢ	Ⓢ	CCC	GL	LRS	BV	DNV	RMRS	RINA	PRS	ABS	
Motor starters	3RK1 322	+	+	x	+	+/ Δ	+/ Δ	+/ Δ	+/ Δ	O	+/ Δ	+/ Δ	+/ Δ	
ECOFAST motor starters (available soon)	3RK1 323	+	+	x	+	-	-	-	-	-	-	-	-	
	6EP16 32-1AL01	+	+	-	-	-	-	-	-	-	-	-	-	
PROFIBUS DP, ET 200X Motor Starters	3RK1 300	+	+	x	+	+	+	+	+	-	+	+	+	
ET 200S	3RK1 301	+	+	x	+	-	-	-	-	-	-	-	-	
ECOFAST	3RK1 303	+	+	x	+	-	-	-	-	-	-	-	-	
ECOFAST accessories ET 200X accessories	3RK1 9	+	+	x	+	+/ Δ	+/ Δ	+/ Δ	+/ Δ	-	+/ Δ	+/ Δ	+/ Δ	
SIMOCODE-DP	3UF5	+	+	x	+	+	+	-	+	-	-	-	-	
	3UF7	+	O	x	O	-	-	-	-	-	-	-	-	
Current transformers	3UF18	+	+	x	-	-	-	-	-	-	-	-	-	
LOGO! Basic variant	6ED1 052	+	+	x	+	+	+	+	+	-	-	+	+	
AS-1 variant	6ED1 055	+	+	x	+	+	+	+	+	-	-	+	+	
Expansion module														
SIRIUS motor starter protectors up to 100 A ⁴⁾	3RV10 11	+ ³⁾	+ ³⁾	+	+	+	+	+	+	+	+	+	-	
	3RV10 21	+ ³⁾	+ ³⁾	x	+	+	+	+	+	+	+	+	-	
	3RV10 31	+ ³⁾	+ ³⁾	x	+	+	+	+	+	+	+	+	-	
	3RV10 4.	+ ³⁾	+ ³⁾	x	+	+	+	+	+	+	+	+	-	
	3RV11 21	+	+	x	+	-	-	-	-	+	-	+	-	
	3RV11 31	+	+	x	+	-	-	-	-	+	-	+	-	
	3RV11 4.	+	+	x	+	-	-	-	-	+	-	+	-	
	3RV13 21	+	+	x	+	+	+	-	+	+	+	+	-	
	3RV13 31	+	+	x	+	+	+	-	+	+	+	+	-	
	3RV13 4.	+	+	x	+	+	+	-	+	+	+	+	-	
	3RV16 11.1	+	+	x	+	-	-	-	-	+	-	+	-	
	3RV14 21	+ ⁴⁾	+ ⁴⁾	x	+	+	+	-	+	+	+	+	-	
	3RV14 31	+ ⁴⁾	+ ⁴⁾	x	+	+	+	-	+	+	+	+	-	
	3RV17 42	+	+	x	O	-	-	-	-	-	-	-	-	
	Accessories for 3RV motor starter protectors ⁵⁾	3RV19 01	+	+	x	+	+	+	+	+	+	+	+	-
		3RV19 .2	+	+	x	+	+	+	+	+	+	+	+	-
3RV19 36/46		-	-	-	+	-	-	-	-	-	+	-	-	
3RV19 .7		+	+	-	+	-	-	-	-	-	-	-	-	
3RV19 .8-1A		-	-	-	+	-	-	-	-	-	-	-	-	
3RV19 08		-	-	-	+	-	-	-	-	-	-	-	-	
3RV19 13		-	-	-	+	-	-	O	-	O	+	-	-	
3RV19 18		-	-	-	+	-	-	O	+	-	-	-	-	
3RV19 23		-	-	-	+	-	-	O	-	O	+	-	-	
3RV19 28-1H		+	+	-	+	-	-	-	-	-	-	-	-	
3RV19 15		+	+	x	+	-	-	+	-	+	+	+	-	
3RV19 35	+	+	x	+	-	-	+	-	+	+	+	-		
3RV19 21-1M	+	+	x	+	+	-	+	+	+	+	+	-		

- + Standard version approved.
- Not yet submitted for approval.
- O Equipment submitted for approval, please inquire.
- x \mathcal{S} approval not required because \mathcal{S} approved.
- Δ Note remarks on marine products (AS-Interface) at <http://www.siemens.com/automation/support>.

- 1) For guide numbers and file numbers for the approvals, visit our website at <http://www.siemens.com/automation/support>.
- 2) \mathcal{S} and \mathcal{S} approvals are available in accordance with US approval.
- 3) Approval as "Type E" combination motor controller and as tap conductor protection device.
- 4) Approval for motorized loads only (not for transformers)
- 5) For approved rated data, please see chapter 5, "Protection equipment: Motor starter protectors".

Standards and approvals

Equipment	Type	Approvals				Marine classifications							
		Canada 1)2)	USA 1)		China	Germany	United Kingdom	France	Norway	CIS	Italy	Poland	USA
		☉	☉	☉	CCC	GL	LRS	BV	DNV	RMRS	RINA	PRS	ABS
SIRIUS 3RT10 contactors	3RT10 1.	+	+	x	+	+	+	+	+	+	+	+	-
	3RT10 2.	+	+	x	+	+	+	+	+	+	+	+	-
	3RT10 3.	+	+	x	+	+	+	+	+	+	+	+	-
	3RT10 4.	+	+	x	+	+	+	+	+	+	+	+	-
	3RT10 5.-A	+	+	x	+	+	+	-	+	-	-	-	-
	3RT10 5.-N	+	+	x	+	+	+	-	+	-	-	-	-
	3RT10 5.-P	+	+	x	+	+	+	-	+	-	-	-	-
	3RT10 5.-Q	+	+	x	+	+	+	-	+	-	-	-	-
	3RT10 6.-A	+	+	x	+	+	+	-	+	-	-	-	-
	3RT10 6.-N	+	+	x	+	+	+	-	+	-	-	-	-
	3RT10 6.-P	+	+	x	+	+	+	-	+	-	-	-	-
	3RT10 6.-Q	+	+	x	+	+	+	-	+	-	-	-	-
	3RT10 7.-A	+	+	x	+	+	+	-	+	-	-	-	-
	3RT10 7.-N	+	+	x	+	+	+	-	+	-	-	-	-
3RT10 7.-P	+	+	x	+	+	+	-	+	-	-	-	-	
3RT10 7.-Q	+	+	x	+	+	+	-	+	-	-	-	-	
SIRIUS 3RT12 vacuum contactors	3RT12 6.-A	+	+	x	+	+	-	+	-	-	-	-	
	3RT12 6.-N	+	+	x	+	+	-	+	-	-	-	-	
	3RT12 7.-A	+	+	x	+	+	-	+	-	-	-	-	
	3RT12 7.-N	+	+	x	+	+	-	+	-	-	-	-	
SIRIUS 3RT14 contactors for switching resistive loads	3RT14 4.	+	+	x	+	+	-	+	-	-	-	-	
	3RT14 56-A	+	+	x	+	+	-	+	-	-	-	-	
	3RT14 56-N	+	+	x	+	+	-	+	-	-	-	-	
	3RT14 56-P	+	+	x	+	+	-	+	-	-	-	-	
	3RT14 56-Q	+	+	x	+	+	-	+	-	-	-	-	
	3RT14 66-A	+	+	x	+	+	-	+	-	-	-	-	
	3RT14 66-N	+	+	x	+	+	-	+	-	-	-	-	
	3RT14 66-P	+	+	x	+	+	-	+	-	-	-	-	
	3RT14 66-Q	+	+	x	+	+	-	+	-	-	-	-	
	3RT14 76-A	+	+	x	+	+	-	+	-	-	-	-	
3RT14 76-N	+	+	x	+	+	-	+	-	-	-	-		
3RT14 76-P	+	+	x	+	+	-	+	-	-	-	-		
3RT14 76-Q	+	+	x	+	+	-	+	-	-	-	-		
SIRIUS 3RT 4-pole contactors	3RT13	+	+	x	+	-	-	-	-	-	-	-	
	3RT15	+	+	x	+	-	-	-	-	-	-	-	
SIRIUS 3RT16 capacitor contactors	3RT16	○	+	x	+	-	-	-	-	-	-	-	
SIRIUS 3RH contactor relays (extended operating range)	3RH11 22-2K	+	+	x	+	+	+	+	+	+	+	-	
SIRIUS coupling relays	3RT10	+	+	x	+	+	+	+	+	+	+	-	
	3RH11	+	+	x	+	+	+	+	+	+	+	-	
Accessories for 3RT and 3RH	3RH19 11	+	+	x	+	+	+	+	+	+	+	-	
	3RH19 21	+	+	x	+	+	+	+	+	+	+	-	
	3RT19 .6-1....	+	+	x	+	+	+	+	+	+	+	-	
	3RT19 .6-2....	+	+	x	+	+	+	+	+	+	+	-	
	3RT19 46-4GH07	+	+	x	+	-	-	-	-	-	-	-	

- + Standard version approved.
- Not yet submitted for approval.
- Equipment submitted for approval, please inquire.
- x ☉ approval not required because ☉ approved.
- △ Note remarks on marine products (AS-Interface) at <http://www.siemens.com/automation/support>.

- 1) For guide numbers and file numbers for the approvals, visit our website at <http://www.siemens.com/automation/support>.
- 2) ☉ and ☉ approvals are available in accordance with US approval.

Appendix

Standards and approvals

Equipment	Type	Approvals				Marine classifications							
		Canada 1)2)	USA 1)		China	Germany	United Kingdom	France	Norway	CIS	Italy	Poland	USA
		Ⓢ	Ⓢ	Ⓢ	CCC	GL	LRS	BV	DNV	RMRS	RINA	PRS	ABS
SIRIUS 3RA13 reversing contactors	3RA13 1.	+	+	x	+	+	+	+	+	+	+	+	-
SIRIUS 3RA14 wye-delta combinations	3RA14 1	+	+	x	+	+	+	+	+	+	+	-	-
Accessories for 3RA1	3RA19 13-2B	+	+	x	+	+	+	+	+	+	+	+	-
	3RA19 13-3K	+	+	x	+	+	+	+	+	+	+	+	-
	3RA19 23-2B	+	+	x	+	+	+	+	+	+	+	+	-
	3RA19 23-3B	+	+	x	+	+	+	+	+	+	+	+	-
	3RA19 24-...	+	+	x	+	+	+	+	+	+	+	+	-
	3RA19 33-2B	+	+	x	+	+	+	+	+	+	+	+	-
	3RA19 43-2B	+	+	x	+	+	+	+	+	+	+	+	-
	3RA19 .6-4B	+	+	x	+	+	+	+	+	+	+	+	-
3-phase EMC interference suppression module	3RT19 16	+	+	-	+	+	+	+	+	+	+	+	-
3TF68/3TF69 contactors	3TF68 ..-0C	+	+	x	+	+	+	+	+	+	-	-	-
	3TF68 ..-1D	+	+	x	+	+	+	+	+	+	-	-	-
	3TF68 ..-1Q	+	+	x	+	+	+	+	+	+	-	-	-
	3TF68 ..-8C	-	-	-	+	+	+	+	+	+	-	-	-
	3TF68 ..-8D	-	-	-	+	+	+	+	+	+	-	-	-
	3TF68 ..-8Q	-	-	-	+	+	+	+	+	+	-	-	-
	3TF69 ..-0C	+	+	x	+	+	+	+	+	+	-	-	-
	3TF69 ..-1D	+	+	x	+	+	+	+	+	+	-	-	-
	3TF69 ..-1Q	+	+	x	+	+	+	+	+	+	-	-	-
	3TF69 ..-8C	-	-	-	+	+	+	+	+	+	-	-	-
	3TF69 ..-8D	-	-	-	+	+	+	+	+	+	-	-	-
	3TF69 ..-8Q	-	-	-	+	+	+	+	+	+	-	-	-
3TG10 contactors	3TG10 ...-0	+	+	x	+	-	-	-	-	-	-	-	-
3TD reversing contactor assemblies	3TD68	+	+	x	○	-	-	-	-	-	-	-	-
Surge suppressors	3TX7 4, 3TX7 522	+	+	x	-	-	-	-	-	-	-	-	-
3TK1 contactors with 4 NO main-contactors	3TK1	+	+	x	+	-	-	-	-	-	-	-	-
3T contactors with extended operating range	3T... ..-0L	+	+	x	-	-	-	-	-	-	-	-	-
SIRIUS SC semiconductor switching devices	3RF2	+	+	x	m	-	-	-	-	-	-	-	-
Contactor relays	3RH11/12, 3RH14	+	+	x	+	+	+	+	+	+	+	+	-
	3TH42, 3TH43	+	+	x	+	+	+	+	+	+	+	+	-
3RU11 thermal overload relays	3RU11 1.	+	+	x	+	+	+	+	+	+	+	+	-
	3RU11 2.	+	+	x	+	+	+	+	+	+	+	+	-
	3RU11 3.	+	+	x	+	+	+	+	+	+	+	+	-
	3RU11 4.	+	+	x	+	+	+	+	+	+	+	+	-
3RB1 solid-state overload relays	3RB10	+	+	x	+	+	-	+	-	-	-	+	-
	3RB12	+	+	x	+	+	-	+	-	-	-	-	-
Accessories for 3RU11 + 3RB10	3RU19 .6-3A	+	+	x	+	+	+	+	+	+	+	+	-
	3RU19 00-1	+	+	x	+	+	+	+	+	+	+	+	-
	3RU19 00-2	+	+	x	+	+	+	+	+	+	+	+	-
3RA11/3RA12/3RA5 SIRIUS load feeders	3RA11, 3RA12	+ ³⁾ ○ ³⁾	+ ³⁾ ○ ³⁾	x	+	+	+	+	-	-	+	-	-
	3RA5	+ ³⁾ ○ ³⁾	+ ³⁾ ○ ³⁾	x	+	○	+	+	-	-	+	-	-
3RE encapsulated starters	3RE	-	-	-	-	-	-	-	-	-	-	-	-

- + Standard version approved.
- Not yet submitted for approval.
- Equipment submitted for approval, please inquire.
- x  approval not required because Ⓢ approved.
- m For exporting products to the People's Republic of China, CCC marking is not necessary.

- 1) For guide numbers and file numbers for the approvals, visit our website at <http://www.siemens.com/automation/support>.
- 2) Ⓢ and  approvals are available in accordance with US approval.
- 3) Single devices approved for assemblies.

Standards and approvals

Equipment	Type	Approvals				Marine classifications							
		Canada 1)2)	USA 1)	1)	China	Germany	United Kingdom	France	Norway	CIS	Italy	Poland	
		☉	☉	☉	CCC	GL	LRS	BV	DNV	RMRS	RINA	PRS	
SIKOSTART	3RW22 21 to 3RW22 31, 3RW34	+	+	x	+	-	-	-	-	-	-	+	
SIRIUS solid-state soft starters	3RW30, 3RW31	+	+	x	+	+	+	-	+	-	-	+	
	3RW30 03	+	+	x	+	+	+	-	+	-	-	+	
	3RW40	x	+	x	+	-	-	-	-	-	-	-	
	3RW44	x	+	x	+	+	+	+	+	-	-	-	
SIRIUS timing relays	3RP15	+	+	x	+	+	+	+	+	+	+	+	
	3RP20	+ ²⁾	+	-	-	+	+	+	+	+	+	+	
	7PV3	+ ²⁾	-	+	-	-	-	-	-	-	-	-	
7PV4	+ ²⁾	-	+	-	-	-	-	-	-	-	-		
SIRIUS temperature monitoring relays	3RS10	+	+	-	+	-	-	-	-	-	-	-	
	3RS11	+	+	-	+	-	-	-	-	-	-	-	
SIRIUS thermistor motor protection	3RN1	+	+	x	+	+	+	+	+	-	-	+	
SIRIUS monitoring relays	3UG3	+ ²⁾	+	+	+	-	-	-	-	-	-	-	
SIRIUS interfaces, slim design	3RS18	+	+	x	+	-	-	-	-	-	-	-	
	3TX7 01¹⁾	+	+	x	+	-	-	-	-	-	-	-	
	3TX7 002, 3TX7 003	+	+	x	+	-	-	-	-	-	-	-	
	3TX7 004, 3TX7 005	+	+	x	+	-	-	-	-	-	-	-	
SIRIUS plug-in relays, relay couplers	LZX : MT	+ ²⁾	-	+	+	-	-	-	-	-	-	-	
	LZX : PT	+ ²⁾	-	+	+	-	-	-	-	-	-	-	
	LZX : RT	+ ²⁾	-	+	+	-	-	-	-	-	-	-	
	LZX : RY	+ ²⁾	-	+	+	-	-	-	-	-	-	-	
SIRIUS power relays	3TG10 ...0	+	+	x	+	-	-	-	-	-	-	-	
Interface converters/ isolation amplifiers	3RS17	+ ²⁾	+	-	m	-	-	-	-	-	-	-	
Position switches	3SE2 100/120	+	+	x	+	•	•	•	•	-	•	•	
	3SE3 0	+	+	+	+	•	•	•	•	-	•	•	
Safety position switches	3SE2 120-1X.	+	+	x	+	•	•	•	•	-	•	•	
	3SE2 120-6XX	+	+	x	+	•	•	•	•	-	•	•	
	3SE2 240	+	+	x	+	•	•	•	•	-	•	•	
	3SE2 243/253	+	+	x	+	•	•	•	•	-	•	•	
	3SE3 160/180	-	+	x	-	-	-	-	-	-	-	-	
	3SE3 7./8.	+	+	x	-	-	-	-	-	-	-	-	
	3SE2 83., 3SE2 84.	+	+	x	+	-	-	-	-	-	-	-	
3SE2 9	+	+	x	+	-	-	-	-	-	-	-		
Signaling columns	8WD4/8WD5	+	+	x	-	•	•	•	•	-	•	•	
Magnetically operated switches	3SE6	+	+	x	-	-	-	-	-	-	-	-	
Cable-operated switches	3SE7	+	+	x	-	-	-	-	-	-	-	-	
Safety combinations	3TK28 21 to 24/30	+	+	x	m	-	-	-	-	-	-	-	
	3TK28 25, 3TK28 27/28	+	+	x	m	-	-	-	-	-	-	-	
	3TK28 34, 3TK28 35	+	+	x	m	-	-	-	-	-	-	-	
	3TK28 40 to 3TK28 45	+	+	x	m	-	-	-	-	-	-	-	
	3TK28 50 to 3TK28 57	+	+	x	m	-	-	-	-	-	-	-	
	3RA71	+	+	x	m	-	-	-	-	-	-	-	

- + Standard version approved.
- Not yet submitted for approval.
- Equipment submitted for approval, please inquire.
- x ☉ approval not required because ☉ approved.
- Approved for operation in connection with AS-Interface, also approved by ABS (American Bureau of Shipping).
- m For exporting products to the People's Republic of China, CCC marking is not necessary.

- 1) For guide numbers and file numbers for the approvals, visit our website at <http://www.siemens.com/automation/support>.
- 2) ☉ or ☉ approval.

Appendix

Standards and approvals

Equipment	Type	Approvals				Marine classifications						
		Canada 1)2)	USA 1)	1)	China	Germany	United Kingdom	France	Norway	CIS	Italy	Poland
		☉	☉	☉	CCC	GL	LRS	BV	DNV	RMRS	RINA	PRS
Pushbuttons and indicator lights, mounting diameter 16 mm	Actuators with holders, complete units, lampholders, contact blocks and voltage reducers											
	3SB20	+	+	x	+	-	-	-	-	-	-	-
	3SB22	+	+	x	+	-	-	-	-	-	-	-
	3SB23	+	+	x	+	-	-	-	-	-	-	-
	3SB24	+	+	x	+	-	-	-	-	-	-	-
Pushbuttons and indicator lights³⁾, mounting diameter 22 mm, round type	Actuators with holders, complete units, switching elements, lampholders and transformers (screw-type and solder pin terminals)											
	3SB30	+	+	x	+	•	•	•	•	-	•	•
	3SB32	+	+	x	+	•	•	•	•	-	•	•
	3SB33	+	+	x	+	-	-	-	-	-	-	-
	3SB34 (screw-type)	+	+	x	+	•	•	•	•	-	•	•
	3SB34 (solder pin)	+	-	+	+	•	•	•	•	-	•	•
	3SB35/3SB36	+	+	x	+	-	-	-	-	-	-	-
	3SB38	+	+	x	+	•	•	•	•	-	•	•
Pushbuttons and indicator lights³⁾, mounting cutout 26 x 26 mm	Actuators with holders, complete units, switching elements, lampholders and transformers (screw-type and solder pin terminals)											
	3SB31	+	+	x	+	•	•	•	•	-	•	•
	3SB33	+	+	x	+	•	•	•	•	-	•	•

Footnotes to page 20/22.

- + Standard version approved.
 - Not yet submitted for approval.
 - Equipment submitted for approval, please inquire.
 - x ☉ approval not required because ☉ approved.
 - Approved for operation in connection with AS-Interface, also approved by ABS (American Bureau of Shipping).
- 1) For guide numbers and file numbers for the approvals, visit our website at <http://www.siemens.com/automation/support>.
 - 2) ☉ and ☉ approvals are available in accordance with US approval.
 - 3) A test certificate has been issued for EMERGENCY-STOP command devices and switching elements with screw-type or solder pin terminals by the BIA (German statutory industrial accident insurance institution).

Footnotes to page 20/23.

- + Standard version approved.
 - Not yet submitted for approval.
 - Equipment submitted for approval, please inquire.
 - x ☉ approval not required because ☉ approved.
- 1) For guide numbers and file numbers for the approvals, visit our website at <http://www.siemens.com/automation/support>.
 - 2) ☉ and ☉ approvals are available in accordance with US approval.
 - 3) Not for circuit-breakers for motor protection. Not for 3VF3 used with the standard switching capacity 25 kA.
 - 4) Also approved by the American Bureau of Shipping (ABS).
 - 5) Also approved by the China Classification Society (CCS).
 - 6) Also approved by Nippon Kaiji Kyokai (NK)
 - 7) Listed as an "Industrial control switch" (on request). According to UL508, can only be used as a "General use switch" in conjunction with UL/CSA back-up fuses, see chapter 16 "Compact circuit-breakers (MCCB)". Circuit-breakers according to UL489 on request.
 - 8) For 3VF6 rated current reduced to 600 A.
 - 9) Approved rated data, see chapter 17 "Switch Disconnectors and SENTRIC fuse switch disconnectors"
 - 10) Approved as fuse base.

Standards and approvals

Equipment	Type	Approvals				Marine classifications									
		Canada (1)(2)	USA (1)	UK (1)	China CCC	Germany GL	United Kingdom LRS	France BV	Norway DNV	CIS RMRS	Italy RINA	Poland PRS	USA ABS		
SENTRON WL circuit-breakers up to 6300 A (ACB)	3WL1	-	-	-	+	+	+	+	-	-	+	+			
	3WL5	0	+	-	-	-	-	-	-	-	-	-			
	3WN6 ⁽³⁾⁽⁴⁾⁽⁵⁾⁽⁶⁾	-	-	-	+	+	+	+	-	+	+				
SENTRON VL circuit-breakers up to 1600 A (MCCB)	3VL4/6/7/8	-	-	-	+	+	+	+	+	+	+ +			
	3VL1/2/3/5/9	-	-	-	+	+	+	+	+	+	+ +			
	3VF2	-	-	-	+	-	-	-	-	-	-	-			
	3VF3 ⁽³⁾⁽⁴⁾ , 3VF4 ⁽⁴⁾	- ⁽⁷⁾	- ⁽⁷⁾	-	+	+	+	+	+	+	+	+			
	3VF5 ⁽³⁾⁽⁴⁾ , 3VF6 ⁽³⁾⁽⁴⁾ 3VF7 ⁽⁴⁾ , 3VF8 ⁽⁴⁾	- ⁽⁷⁾	- ⁽⁷⁾	-	+	+	+	+	+	+	+	+			
Fuse switch disconnectors	3NP35/3NP40 1	-	-	+ ⁽¹⁰⁾	0	+	-	-	-	-	-	+			
	3NP35/3NP40 7	-	-	+ ⁽¹⁰⁾	0	-	-	-	-	-	-	-			
	3NP35/3NP4	-	-	-	0	-	-	-	-	-	-	+			
	3NP50 to 3NP54	-	-	-	0	-	-	-	-	-	-	+			
	3NP5. 6.-.H	-	-	-	0	-	-	-	-	-	-	+			
SENTRON WL circuit-breakers up to 6300 A (ACB)	3WL1	-	-	-	+	+	+	+	-	-	+	+			
	3WL5	0	+	-	-	-	-	-	-	-	-	-			
	3WN6 ⁽³⁾⁽⁴⁾⁽⁵⁾⁽⁶⁾	-	-	-	+	+	+	+	-	+	+				
	3VL4/6/7/8	-	-	-	0	0	+	-	0	-	-	-			
	3VL1/2/3/5/9	-	-	-	0	+	+	-	0	-	-	-			
SENTRON VL circuit-breakers up to 1600 A (MCCB)	3VF2	-	-	-	+	-	-	-	-	-	-	-			
	3VF3 ⁽³⁾⁽⁴⁾ , 3VF4 ⁽⁴⁾	- ⁽⁷⁾	- ⁽⁷⁾	-	+	+	+	+	+	+	+	+			
	3VF5 ⁽³⁾⁽⁴⁾ , 3VF6 ⁽³⁾⁽⁴⁾	- ⁽⁷⁾	- ⁽⁷⁾	-	+	+	+	+	+	+	+	+			
	3VF7 ⁽⁴⁾ , 3VF8 ⁽⁴⁾	-	-	-	+	+	+	+	+	+	+	+			
	3VF7 ⁽⁴⁾ , 3VF8 ⁽⁴⁾	-	-	-	+	+	+	+	+	+	+	+			
Switchable fuse switch disconnectors	3NJ4	-	-	-	0	-	-	-	-	-	-	-			
Switch disconnectors with fuses	3KL50, 3KM50	-	-	-	0	+	+	+	-	+	-	+			
	3KL52, 3KM52	+ ⁽⁹⁾	-	+ ⁽⁹⁾	0	+	+	-	-	-	-	+			
	3KL53, 3KM53	-	-	+ ⁽⁹⁾	0	-	-	-	-	-	-	+			
	3KL55, 3KM55	+ ⁽⁹⁾	-	+ ⁽⁹⁾	0	+	+	-	-	-	-	+			
	3KL57, 3KM57	+ ⁽⁹⁾	-	+ ⁽⁹⁾	0	+	+	-	-	-	-	+			
SITOR fuses	3NE	-	-	+	0	-	-	-	-	-	-	-			
	3NC	-	-	+	0	-	-	-	-	-	-	-			
	3NC1 09, 3NC1 49 3NC2 29	+	-	+	0	-	-	-	-	-	-	-			
LV HRC fuse links 500 V AC/440 V DC	3NA3 00., 3NA3 010 3NA3 012	-	-	-	-	-	-	-	-	-	+	-			
	3NA3 014, 3NA3 017 3NA3 02., 3NA3 03.	+	-	-	-	-	-	-	-	-	+	-			
	3NA3 10., 3NA3 110 3NA3 114, 3NA3 117	-	-	-	-	+	+	-	-	-	+	-			
	3NA3 12., 3NA3 13. 3NA3 14.	+	-	-	-	+	+	-	-	-	+	-			
	3NA3 214 3NA3 220, 3NA3 222 3NA3 224, 3NA3 23.	-	-	-	-	+	-	-	-	-	-	-			
	3NA3 240 3NA3 242, 3NA3 244	+	-	-	-	+	+	-	-	-	+	-			
	3NA3 250 3NA3 252, 3NA3 260 3NA3 254	+	-	-	-	+	-	-	-	-	+	-			
	3NA3 340, 3NA3 340 3NA3 35., 3NA3 360	-	-	-	-	+	-	-	-	-	+	-			
	3NA3 362, 3NA3 365 3NA3 372	-	-	-	-	+	-	-	-	-	+	-			
	3NA3 47., 3NA3 480 3NA3 6..	-	-	-	-	-	-	-	-	-	-	-			
	3NA3 801, 3NA3 803 3NA3 802, 3NA3 804 3NA3 805, 3NA3 807	-	-	-	-	+	+	-	-	-	+	-			
	3NA3 810 3NA3 812, 3NA3 814 3NA3 817, 3NA3 82.	-	-	-	-	+	+	-	-	-	+	-			
	3NA3 830 3NA3 832 3NA3 836	+	-	-	-	+	+	-	-	-	+	-			
	LV HRC fuse links 690 V AC	3NA3 1.. 3NA3 2.. 3NA3 3..	-	-	-	-	-	-	-	-	-	-	-		
		3NA3 80., 3NA3 810 3NA3 812, 3NA3 817	-	-	-	-	-	-	-	-	-	-	-		
		3NA3 814 3NA3 82., 3NA3 830	-	-	-	-	-	-	-	-	-	-	-		

Appendix

Standards and approvals

Equipment	Type	Approvals					Marine classifications								
		Canada 1)2)	USA 1)	1)	China	Germany	United Kingdom	France	Norway	CIS	Italy	Poland	USA		
		CE	cULUS	UL	CCC	GL	LRS	BV	DNV	RMRS	RINA	PRS	ABS		
Switch disconnectors	3KA50	-	-	-	O	+	+	+	-	+	-	+	-		
	3KA51, 3KA55, 3KA58	-	-	-	O	-	-	-	-	-	-	+	-		
	3KA53	+ ³⁾	x	+ ³⁾	x	O	+	-	-	-	-	+	-		
	3KA57	+ ³⁾	x	+ ³⁾	x	O	+	-	-	-	-	+	-		
	3KE4	-	-	-	-	-	-	-	-	+	-	+	-		
Busbar adapter systems	8US1	+	+	-	+	-	-	-	-	-	-	-	-		
Transformers	4AM, 4AP, 4AT, 4AU ⁴⁾	-	+	-	+	m	-	-	-	-	-	+	-		
	4BT, 4BU	-	+	-	+	m	-	-	-	-	-	-	-		
	4AX, 4FK	-	-	-	-	m	-	-	-	-	-	+	-		
DC power supplies	4AV21, 4AV23	-	+ ⁶⁾	-	+	m	-	-	-	-	-	+	-		
	4AV20, 4AV22, 4AV24, 4AV26	-	+	-	+	m	-	-	-	-	-	+	-		
	4AV30 to 4AV35 6EP1	- ⁵⁾	+	-	+	m	+ ⁵⁾	+ ⁵⁾	-	+ ⁵⁾	-	+	+ ⁵⁾		
Load/system power supplies	4FD51	-	-	-	+	x	•	•	•	•	•	•	-		
Control switches and main control switches Basic units and flush-mounting switches	3LD2	+	x	+	x	O	+	+	-	+	-	+	-		
	3LD2. 64/65/66	+	x	+		O									
Molded-plastic distribution systems	8HP	-	-	O	-	-	-	-	-	-	-	-	-		

- + Standard version approved.
 - Not yet submitted for approval.
 - O Equipment submitted for approval, please inquire.
 - x **UL** approval not required because **UL** approved.
 - Approved for operation in connection with AS-Interface, also approved by ABS (American Bureau of Shipping).
- m For exporting products to the Peoples Republic of China, CCC marking is not necessary.

- 1) For guide numbers and file numbers for the approvals, visit our website at <http://www.siemens.com/automation/support>.
- 2) **cUL** and **cULUS** approvals are available in accordance with US approval, unless otherwise specified.
- 3) **UL**, **cUL** and **CE** approved rated data, see chapter 16, "Molded case circuit-breakers (MCCB)".
- 4) Transformers acc. to VDE 107 are not **UL**, **cUL** and **cULUS** approved.
- 5) Partly, see Catalog KT 10.1, power supply SITOP Power.
- 6) **UL/CE** approvals will be superseded by the **cULUS** approvals.

Standards and approvals

Equipment	Type	Approvals										Marine classifications							
		Canada 1)2)	USA 1)	1)	China	Czech Re- public	Slova- kia	Po- land	Hun- gary	Ger- many	United King- dom	France	Nor- way	CIS	Italy	Po- land	USA		
		©	c [®] US	®	c [®] US	®	CCC	EZU	SKTC	SEP	MEEI	GL	LRS	BV	DNV	RMRS	RINA	PRS	ABS
Terminal blocks For © and approved ratings of terminal blocks, see technical specifications	8WA1 010-1PH01	+	-	-	-	-	+	-	-	+	-	-	-	-	-	-	+	-	
	8WA1 010-1PQ00	+	-	-	-	-	-	-	-	-	-	-	-	-	-	-	-	-	
	8WA1 011-0D	+	-	+	+	+	-	+	+	+	+	+	+	-	-	-	+	+	
	8WA1 011-1BF21	+	-	+	+	+	-	+	+	+	+	+	+	-	-	-	+	+	
	8WA1 011-1BF22	+	-	+	+	+	-	+	+	+	+	+	+	-	-	-	+	+	
	8WA1 011-1BF23	+	-	+	+	+	-	+	+	+	+	+	+	-	-	-	+	+	
	8WA1 011-1BF24	+	-	+	-	-	-	-	-	+	+	+	+	-	-	-	-	-	
	8WA1 011-1BF25	+	-	+	-	-	-	-	-	-	-	-	-	-	-	-	-	-	
	8WA1 011-1BG11	+	-	+	+	+	-	+	+	+	+	+	+	-	-	-	+	+	
	8WA1 011-1BG21	+	-	+	+	+	-	+	+	+	+	+	+	-	-	-	+	+	
	8WA1 011-1BG22	+	-	+	+	+	-	+	+	+	+	+	+	-	-	-	+	+	
	8WA1 011-1BG24	+	-	+	-	-	-	-	-	+	+	+	+	-	-	-	-	+	
	8WA1 011-1BH23	+	-	+	+	+	-	+	+	+	+	+	+	-	-	-	-	+	
	8WA1 011-1BH24	+	-	+	-	-	-	-	-	+	+	+	+	-	-	-	-	+	
	8WA1 011-1BK11	+	-	+	+	+	-	+	+	+	+	+	+	-	-	-	+	+	
	8WA1 011-1BM11	+	-	+	+	+	-	+	+	+	+	+	+	-	-	-	+	+	
	8WA1 011-1BP11	-	-	-	+	+	-	+	+	+	+	+	+	-	-	-	+	+	
	8WA1 011-1DF11	+	-	+	+	+	-	+	+	+	+	+	+	-	-	-	+	+	
	8WA1 011-1DG11	+	-	+	+	+	-	+	+	+	+	+	+	-	-	-	+	+	
	8WA1 011-1DH11	+	-	+	+	+	-	+	+	+	+	+	+	-	-	-	+	+	
	8WA1 011-1DQ10	-	+	+	+	+	-	-	-	-	-	-	-	-	-	-	-	-	
	8WA1 011-1DS10	-	+	+	+	+	-	-	-	-	-	-	-	-	-	-	-	-	
	8WA1 011-1DU10	-	+	+	+	+	-	-	-	-	-	-	-	-	-	-	-	-	
	8WA1 011-1EF20	-	-	-	+	-	-	+	-	-	-	-	-	-	-	-	-	+	
	8WA1 011-1MH1.	+ ³⁾	-	+	+	+	-	+	+	+	+	+	+	+	+	-	-	+	
	8WA1 011-1EF28	-	-	-	-	-	-	-	+	-	-	-	-	-	-	-	-	-	
	8WA1 011-1NF01	+	-	+	+	+	-	+	+	+	+	+	+	-	-	-	+	+	
	8WA1 011-1NF02	+	-	+	-	-	-	-	-	+	+	+	+	-	-	-	+	+	
	8WA1 011-1NG31	+	-	+	-	-	-	-	+	+	+	+	+	-	-	-	+	+	
	8WA1 011-1NG32	+	-	+	-	-	-	-	-	+	+	+	+	-	-	-	+	+	

- + Standard version approved.
- Not yet submitted for approval.

- 1) For guide numbers and file numbers for the approvals, visit our website at <http://www.siemens.com/automation/support>.
- 2) c[®] and c[®]US approvals are available in accordance with US approval, unless otherwise specified.
- 3) 600 A, 5 A, Type D or 300 V Type C.

Appendix

Standards and approvals

Equipment	Type	Approvals								Marine classifications							
		Canada 1)2)	USA 1)	1)	Czech Re- public	Slova- kia	Pol- and	Hun- gary	Ger- many	United King- dom	France	Nor- way	CIS	Italy	Poland	USA	
		©	®	UL	EZU	SKTC	SEP	MEEI	GL	LRS	BV	DNV	RMRS	RINA	PRS	ABS	
Terminal blocks For © and UL approved ratings of terminal blocks, see technical specifications	8WA1 011-1NH01	+	-	+	+	+	-	+	+	+	+	-	-	+	+		
	-1NH02	+	-	+	-	-	-	+	+	+	+	-	-	+	+		
	-1NK02	-	-	+	-	+	-	-	+	+	+	-	-	+	+		
8WA1 011-1PF00	-1PF01	+	-	+	+	+	-	+	+	+	+	-	-	+	+		
	-1PF11	+	-	+	+	+	-	+	+	+	+	-	-	+	+		
	8WA1 011-1PG00	+	-	+	+	+	-	+	+	+	+	-	-	+	+		
-1PG01	-1PG11	+	-	+	+	+	-	+	+	+	+	-	-	+	+		
	8WA1 011-1PH00	+	-	+	+	+	-	+	+	+	+	-	-	+	+		
	-1PH11	+	-	+	+	+	-	+	+	+	+	-	-	+	+		
-1PK00	-1PM00	+	-	+	-	-	-	+	+	+	+	-	-	+	+		
	8WA1 011-1SF12	+	-	+	+	+	-	+	+	+	+	-	-	+	+		
	-1SF2.	+	-	+	-	+	-	-	-	-	-	-	-	+	-		
8WA1 011-2BG11	-2DG11	+	-	+	+	-	-	+	+	+	+	-	-	+	+		
	-2SF2.	+	-	+	-	+	-	-	-	-	-	-	-	+	-		
	8WA1 011-3D.21	+	-	+	+	+	-	+	+	+	+	-	-	+	+		
8WA1 011-3JF16 to 8WA1 011-3JF20	+	-	+	+	+	-	+	-	-	-	-	-	-	-			
8WA1 011-4SF2.	-6SF2.	+	-	+	-	+	-	-	-	-	-	-	-	+	-		
	-8SF2.	-	-	-	+	-	-	-	-	-	-	-	-	+	-		
	8WA1 011-6BG11	+	-	+	+	-	-	+	+	+	+	-	-	+	+		
-6DG11	-6EG..	+	-	+	+	+	-	+	+	+	+	-	-	+	+		
	8WA1 012-1DK10	-	-	+	-	-	-	-	-	-	-	-	-	-	-		
	-1D.14	+	-	+	-	-	-	-	-	-	-	-	-	-	-		
8WA1 204 to 206	+	-	+	+	+	-	+	+	+	+	-	-	+	+			
8WA1 211, 8WA1 221	-	-	-	-	+	-	-	-	-	-	-	-	+	-			
8WA1 232	-	-	+	-	+	-	-	-	-	-	-	-	+	-			
8WA1 304, 8WA1 305	+	-	+	+	+	-	+	+	+	+	+	-	-	+	+		
8WA1 501	+	-	+	-	-	-	+	+	+	+	+	-	-	-	-		
8WA1 604	-	-	+	+	+	-	+	+	+	+	+	-	-	+	+		
8WA2 011-1.F2.	-1.G2.	+	-	+	-	-	-	+	+	+	+	-	-	-	+		
	-1.H2.	+	-	+	-	-	-	+	+	+	+	-	-	-	+		
	-1.J2.	+	-	+	-	-	-	+	+	+	+	-	-	-	+		
	-1.K2.	+	-	+	-	-	-	+	+	+	+	-	-	-	+		
	8WA2 011-1.F3.	+	-	+	-	-	-	+	+	+	+	-	-	-	+		
-1.G3.	-2.G4.	+	-	+	-	-	-	+	+	+	+	-	-	-	+		
	8WA2 011-3JG1	+	-	+	-	-	-	+	+	+	+	-	-	-	+		
-3JG30	+	-	+	-	-	-	-	-	-	-	-	-	-	-			
8WA2 011-1NK23	-3JG11	+	-	+	-	-	-	-	-	-	-	-	-	-	-		
	-1EF20	+	-	+	-	-	-	-	-	-	-	-	-	-	-		
	-6EG2.	+	-	+	-	-	-	-	-	-	-	-	-	-	-		
	8WA2 011-3KE..	+	-	+	-	-	-	-	-	-	-	-	-	-	-		
8WA2 511-....	+	+	-	-	-	-	-	-	-	-	-	-	-	-			
8WA3 011-....	+	+	-	-	-	-	-	-	-	-	-	-	-	-			
8WA2 511, 8WA3 011	+	+	-	-	-	-	-	-	-	-	-	-	-	-			
8WA9 200, 8WA9 203	+	-	+	-	-	-	-	-	-	-	-	-	-	+			

- + Standard version approved.
- Not yet submitted for approval.

- 1) For guide numbers and file numbers for the approvals, visit our website at <http://www.siemens.com/automation/support>.
- 2) © and cUL approvals are available in accordance with US approval.

More information

For further information on standards and approvals, please visit our website at <http://www.siemens.com/automation/support> and select "Product Support".

In the event of queries regarding UL/CSA approvals, please contact: Technical Assistance +49 (0)911-895 59 00.

Quality management

The quality management system of our A&D division complies with the international standard EN ISO 9001.

The products and systems described in this catalog are sold under application of a quality management system certified by DQS and TÜV Management Service GmbH in accordance with ISO 9001. The certificates are recognized in all IQ Net countries.

DQS Registered Certificate Nos.:

Siemens AG
Automation and Drives

- Industrial Automation Systems
Reg. No.: 001323 QM
- Industrial Communication SIMATIC NET
Reg. No.: 002613 QM.

TÜV (German Technical Inspectorate) Registered Certificate No.:

Siemens AG
Automation and Drives

- Low-Voltage Controls
Reg. No.: 12 100 16950 TMS.

BVQI Registered Certificate No.:

Siemens AG
Automation and Drives

- Electrical Installation Technology
Reg. No.: 117779

Certificates

An overview of the certificates available for SIMATIC NET products (CE, UL, CSA, FM, shipping authorizations) can be found on the Internet at:

<http://www.siemens.com/simatic-net>

Other certificates for SIMATIC products can be found on the Internet at:

<http://www.siemens.com/simatic>

These lists are continuously revised and updated and data for products not yet included in the overview are continuously collected and prepared for subsequent editions.

You can find certificates, approvals, verification certificates and characteristic curves at:

Support\Infomaterial\Certificates



or by going directly to the Link Box:



Appendix

Siemens contacts

Siemens contacts worldwide



At:

<http://www.siemens.com/automation/partner>

you can find details of Siemens contact partners worldwide responsible for particular technologies.

You can obtain in most cases a contact partner for

- Technical Support,
- Spare parts/repairs,
- Service,
- Training,
- Sales or
- Consultation/engineering.

You start by selecting a

- Country,
- Product or
- Sector.

By further specifying the remaining criteria you will find exactly the right contact partner with his/her respective expertise.

Online services

A&D in the WWW



A detailed knowledge of the range of products and services available is essential when planning and configuring automation systems. It goes without saying that this information must always be fully up-to-date.

The Siemens Automation and Drives Group (A&D) has therefore built up a comprehensive range of information in the World Wide Web, which offers quick and easy access to all data required.

Under the address

<http://www.siemens.com/automation>

you will find everything you need to know about products, systems and services.

Product selection using the interactive catalog

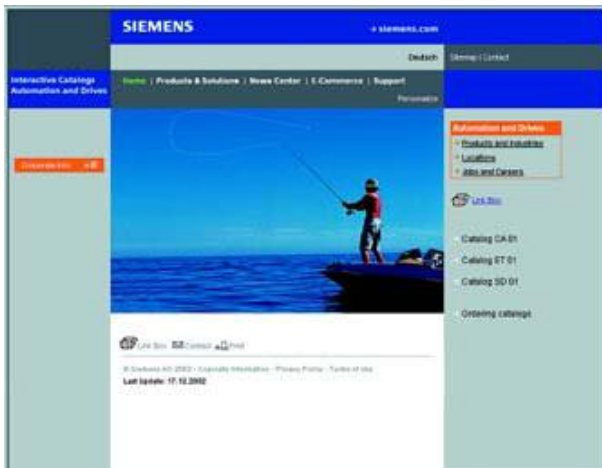

Detailed information together with convenient interactive functions:

The interactive catalog CA 01 covers more than 80,000 products and thus provides a full summary of the Siemens Automation and Drives product base.

Here you will find everything that you need to solve tasks in the fields of automation, switchgear, installation and drives. All information is linked into a user interface which is easy to work with and intuitive.

After selecting the product of your choice you can order at the press of a button, by fax or by online link.

Information on the interactive catalog CA 01 can be found on the Internet under

<http://www.siemens.com/automation/ca01>

or on CD-ROM or DVD.

Easy shopping with the A&D Mall



The A&D Mall is the virtual department store of Siemens AG in the Internet. Here you have access to a huge range of products presented in electronic catalogs in an informative and attractive way.

Data transfer via EDIFACT allows the whole procedure from selection through ordering to tracking of the order to be carried out online via the Internet.

Numerous functions are available to support you.

For example, powerful search functions make it easy to find the required products, which can be immediately checked for availability. Customer-specific discounts and preparation of quotes can be carried out online as well as order tracking and tracing.

Please visit the A&D Mall on the Internet under:

<http://www.siemens.com/automation/mall>

Appendix

Customer support



In the face of harsh competition you need optimum conditions to keep ahead all the time: A strong starting position. A sophisticated strategy and team for the necessary support - in every phase. Service & Support from Siemens provides this support with a complete range of different services for automation and drives.

In every phase: from planning and startup to maintenance and upgrading.

Our specialists know when and where to act to keep the productivity and cost-effectiveness of your system running in top form.

Configuration and software engineering



Support in configuring and developing with customer-oriented services from actual configuration to implementation of the automation project.²⁾

Technical support



Competent consulting in technical questions covering a wide range of customer-oriented services for all our products and systems.

Tel.: +49 (180) 50 50 222
Fax: +49 (180) 50 50 223

E-Mail: ad.support@siemens.com

Online support



The comprehensive information system available round the clock via Internet ranging from Product Support and Service & Support services to Support Tools in the Shop.

<http://www.siemens.com/automation/service&support>

Service on site



With Service On Site we offer services for startup and maintenance, essential for ensuring system availability.

Tel.: +49 (180) 50 50 442²⁾

Technical consulting



Support in the planning and designing of your project from detailed actual-state analysis, target definition and consulting on product and system questions right to the creation of the automation solution.²⁾

Repairs and spare parts



In the operating phase of a machine or automation system we provide a comprehensive repair and spare parts service ensuring the highest degree of operating safety and reliability.

Tel.: +49 (180) 50 50 446²⁾

Technical assistance



Expert technical assistance¹⁾ for Low-voltage controls and electrical installation.

Tel.: +49 (9 11) 8 95-59 00
Fax: +49 (9 11) 8 95-59 07

E-Mail: technical-assistance@siemens.com

Optimization and upgrading



To enhance productivity and save costs in your project we offer high-quality services in optimization and upgrading.²⁾

1) Contact:

Technical assistance for product selection · Old/new coding · Competitor coding · Special versions · Special requirements · Sales promotion (Infoline).
Your regional contacts for sales support (prices, discounts, delivery times).
Technical Support for commissioning support and after-sales services.

2) For country-specific telephone numbers go to our Internet site at: <http://www.siemens.com/automation/service&support>

Overview**Software types**

Software requiring a license is categorized into types. The following software types have been defined:

- Engineering software
- Runtime software

Engineering software

This includes all software products for creating (engineering) user software, e.g. for configuring, programming, parameterizing, testing, commissioning or servicing. Data generated with engineering software and executable programs can be duplicated for your own use or for use by third-parties free-of-charge.

Runtime software

This includes all software products required for plant/machine operation, e.g. operating system, basic system, system expansions, drivers, etc. The duplication of the runtime software and executable programs created with the runtime software for your own use or for use by third-parties is subject to a charge. You can find information about license fees according to use in the ordering data (e.g. in the catalog). Examples of categories of use include per CPU, per installation, per channel, per instance, per axis, per control loop, per variable, etc. Information about extended rights of use for parameterization/configuration tools supplied as integral components of the scope of delivery can be found in the readme file supplied with the relevant product(s).

License types

Siemens Automation & Drives offers various types of software license:

- Floating license
- Single license
- Rental license
- Trial license

Floating license

The software may be installed for internal use on any number of devices by the licensee. Only the concurrent user is licensed. The concurrent user is the person using the program. Use begins when the software is started. A license is required for each concurrent user.

Single license

Unlike the floating license, a single license permits only one installation of the software. The type of use licensed is specified in the ordering data and in the Certificate of License (CoL). Types of use include for example per device, per axis, per channel, etc. One single license is required for each type of use defined.

Rental license

A rental license supports the "sporadic use" of engineering software. Once the license key has been installed, the software can be used for a specific number of hours (the operating hours do not have to be consecutive). One license is required for each installation of the software.

Trial license

A trial license supports "short-term use" of the software in a non-productive context, e.g. for testing and evaluation purposes. It can be transferred to another license.

Certificate of License

The Certificate of License (CoL) is the licensee's proof that the use of the software has been licensed by Siemens. A CoL is required for every type of use and must be kept in a safe place.

Downgrading

The licensee is permitted to use the software or an earlier version/release of the software, provided that the licensee owns such a version/release and its use is technically feasible.

Delivery versions

Software is constantly being updated. The following delivery versions

- PowerPack
- Upgrade

can be used to access updates.

Existing bug fixes are supplied with the ServicePack version.

PowerPack

PowerPacks can be used to upgrade to more powerful software.

The licensee receives a new license agreement and CoL (Certificate of License) with the PowerPack. This CoL, together with the CoL for the original product, proves that the new software is licensed.

A separate PowerPack must be purchased for each original license of the software to be replaced.

Upgrade

An upgrade permits the use of a new version of the software on the condition that a license for a previous version of the product is already held.

The licensee receives a new license agreement and CoL with the upgrade. This CoL, together with the CoL for the previous product, proves that the new version is licensed.

A separate upgrade must be purchased for each original license of the software to be upgraded.

ServicePack

ServicePacks are used to debug existing products. ServicePacks may be duplicated for use as prescribed according to the number of existing original licenses.

License key

Siemens Automation & Drives supplies software products with and without license keys.

The license key serves as an electronic license stamp and is also the "switch" for activating the software (floating license, rental license, etc.).

The complete installation of software products requiring license keys includes the program to be licensed (the software) and the license key (which represents the license).



Detailed explanations concerning license conditions can be found in the "Terms and Conditions of Siemens AG" or under <http://www.siemens.com/automation/mail> (A&D Mail Online-Help System)

Appendix

Subject index

	Page		Page		Page
Numerics					
19" withdrawable fan unit	14/34	40 mm busbar system		Adapters	5/27
3KA, 3KE switch disconnectors up to 1000 A	17/4 ... 17/13	for extended technical requirements	17/59	Busbars	6/44
3LD main and EMERGENCY-STOP switches up to 125 A	17/14 ... 17/31	for extended technical requirements with fuse monitoring by circuit-breaker	17/61	Standard mounting rail	6/43, 6/44
Distribution board mounting	17/24, 17/25	for extended technical requirements with fuse monitoring by electronic circuit-breaker	17/63	Additional components	19/54
Floor mounting	17/20 ... 17/23	for power distribution	17/48	Air conditioners/cooling equipment	14/31
Front mounting	17/15 ... 17/19	for power distribution with fuse monitoring by circuit-breaker	17/51	Alarm switches	5/2, 5/17
Molded-plastic enclosure	17/26, 17/27	60 mm busbar system		ALPHA 630-DIN	
3NJ6 in-line switch disconnectors with fuses up to 630 A	17/43 ... 17/45	for extended technical requirements	17/59	Floor-mounted distribution boards	14/36
3RN1 thermistor motor protection for PTC sensors	7/65 ... 7/68	for extended technical requirements with fuse monitoring by circuit-breaker	17/61	- Accessories	14/50 ... 14/57
3RP, 7PV timing relays	7/30 ... 7/42	for extended technical requirements with fuse monitoring by electronic circuit-breaker	17/63	- Assembly kits	14/40 ... 14/49
3RP15 timing relays in industrial enclosure	7/30 ... 7/35	for power distribution	17/49	- Marshalling boxes	14/39
3RP20 timing relays, 45 mm	7/36?? ... 7/39	for power distribution with fuse monitoring by circuit-breaker	17/52	- Unequipped cubicles	14/37, 14/38
3RS17 interface converters	7/82 ... 7/84	7PV timing relay for panel mounting	7/40	Analog measuring devices	19/122
3RT19 timing relay for mounting to contactors	7/41, 7/42	8HP molded-plastic distribution systems	14/58 ... 14/80	Arc chutes	3/133, 3/142
3RV1 motor starter protectors	5/2 ... 5/30	Accessories		AS-Interface	2/9 ... 2/52
Alarm switches	5/2	- Enclosures	14/71 ... 14/73	A/B technology	2/11
Auxiliary switches	5/2	- Installation	14/74 ... 14/77	ASIsafe	2/12 ... 2/16
Busbar adapters for motor starter protectors	5/2	- Support rack and cable space cover	14/78 ... 14/80	Communication overview	2/10
Cage Clamp infeed systems	5/2	Complete enclosures	14/61, 14/62	Masters	2/17, 2/18
Distance protection	5/13	Infeed enclosures	14/64, 14/65	Power supply units	2/42 ... 2/44
Distance protection, voltage transformer circuit-breakers	5/2	Meter enclosures	14/63	Routers	2/19, 2/20
Door-coupling rotary mechanisms	5/2	Single enclosures	14/60	Slaves	2/21 ... 2/41
Enclosures for flush mounting	5/2	8US busbar systems	14/81 ... 14/103	System components and accessories	
Enclosures for surface mounting	5/2	40 mm	14/83 ... 14/90	- Accessories	2/51 ... 2/52
Front plates	5/2	- Connections	14/85	- Addressing unit	2/47
Fuse monitoring	5/2, 5/11	- Device adapters	14/86 ... 14/90	- Analyzer	2/48 ... 2/50
Insulated three-phase busbar systems	5/2	- Infeed	14/85	- Extension plug	2/46
Isolator modules	5/2	- Switching device holders	14/86 ... 14/90	Transmission media	
Link modules	5/2	60 mm	14/91 ... 14/103	- Shaped cable	2/45
Motor protection	5/2, 5/5 ... 5/7	- Bar-mounting fuse base	14/102	Transmission technology	2/9
Motor protection with overload relay function	5/2, 5/8	- Base assemblies	14/92 ... 14/94	AS-Interface connection for LOGO!	7/25
Plant protection	5/2	- Connections	14/95, 14/96	ASIsafe	
Plant protection according to UL	5/12	- Device adapters	14/97 ... 14/101	Safe modules	2/15, 2/16
Remote motorized operating mechanisms	5/2	- Infeed	14/95, 14/96	Safety monitors	2/14
Shunt releases	5/2	- Switching device holders	14/97 ... 14/101	Assembly frames	14/57
Starter combinations	5/2, 5/9	A		Assembly kits	
Transformer protection	5/2, 5/10	Accessories and spare parts		Accessories	14/52, 14/53, 14/55, 14/56
Undervoltage releases	5/2	for contactors and contactor relays	3/107 ... 3/146	for bus-mounting fuse bases	14/49
3SE2, 3SE3 foot switches	9/111	- Arc chutes	3/133, 3/142	for circuit-breakers	14/47
3SE7, 3SF2 cable-operated switches	9/107	- Auxiliary switch blocks	3/110 ... 3/113, 3/142, 3/144	for fuse switch disconnectors	14/45, 14/46
3TK28 safety relays	7/69 ... 7/79	- Box terminal	3/124	for in-line fuse switch disconnectors	14/48
with contactor relay enabling circuits	7/73 ... 7/76, 7/77 ... 7/79	- Covers	3/124	for installation equipment	14/40
with electronic enabling circuits	7/71, 7/72	- Laterally mountable auxiliary switch blocks	3/114	for modular terminals	14/41, 14/42
3UF18 current transformers for overload protection	7/15	- LED module for indicating contactor operation	3/122	for unequipped sections	14/44
3UL22 summation current transformer	7/16	- Magnetic coils	3/126 ... 3/129, 3/142, 3/144	with mounting plates	14/43
		- OFF-delay devices	3/136, 3/140	Assembly kits for distribution boards	17/55 ... 17/57
		- Solid-state compatible auxiliary switch blocks	3/115, 3/116	Autotransformers	10/47, 10/48, 10/50, 10/61, 10/84, 10/85
		- Solid-state time-delay auxiliary switch blocks	3/117	for matching purposes	10/86, 10/87
		- Solid-state time-delay blocks	3/118	Auxiliary switch blocks	3/110 ... 3/113, 3/142, 3/144
		- Surge suppressors	3/134, 3/137, 3/139, 3/141	Laterally mountable	3/114
		- Surge suppressors without LED	3/119, 3/120	Solid-state compatible	3/115, 3/116
		- Withdrawable coils	3/130 ... 3/132	Solid-state time-delay	3/117
				Auxiliary switches	5/2, 5/16
				Auxiliary terminals	5/25

	Page		Page		Page
B		E		E	
Backup module	11/11	Control devices	7/1 ... 7/84	ECOFAST	2/53 ... 2/55
Barrier	12/23, 12/38, 12/40	Control transformers 10/5 ... 10/48, 10/57 ... 10/62		E-counters	19/125 ... 19/127
Barriers	12/25	Converter transformers	10/50, 10/84, 10/85	Encapsulated starters	
Bases, LV HRC	19/28 ... 19/31	Converters	4/22	Direct-on-line starters	6/121 ... 6/124
Battery modules	11/14	Copper rails	12/49	Reversing starters	6/121 ... 6/124
Blank labeling plates	12/36	Counter modules	2/38	Enclosed transformers	10/51, 10/52
Bolt-type terminals	12/37	Coupling relays		Enclosures, accessories	5/28 ... 5/30
Box terminal	3/124	for switching auxiliary circuits	3/88, 3/89	Enclosures for flush mounting	5/2
Box terminal blocks	5/50	for switching motors	3/90 ... 3/94	Enclosures for surface mounting	5/2
Branch terminals	12/33	Narrow design	3/95 ... 3/100	End labels	12/58
Bridge	12/38	- Plug-in design	3/97, 3/98	End plate	12/38
Busbar adapters	6/44	with industrial housing		End retainers	12/25, 12/36, 12/59
Busbar adapters for motor starter protectors	5/2	- Relay couplers	3/101	Engineering software	18/1 ... 18/6
Busway systems		with warning arrow	12/7, 12/10, 12/11	ET 200S Solutions safety motor starters	
8PS	14/11 ... 14/20	Cover plates	12/7, 12/8, 12/10, 12/11	Local	6/88 ... 6/97
- BD01 system	14/18	Covers 3/124, 12/17, 12/25, 12/27, 12/36, 12/38		PROFIsafe	6/88 ... 6/97
- BD2 system	14/19, 14/20	for neutral busbar	12/33	Evaluation modules	5/47
- CD-K system	14/16, 14/17	Current measuring modules	5/48		
Components for	14/70	Current monitoring	7/49, 7/50		
		Current transformers	14/116 ... 14/120, 19/129		
		Customized versions	12/48		
C		Cylindrical fuses		F	
Cable releases with holder for RESET	5/49, 5/55	Bases	19/33, 19/34	Feed-in terminal	12/47
Cage Clamp infeed systems	5/2	Fuse links	19/32	for neutral busbar	12/36
Capacitor contactors	3/66	- for motor circuits	19/45	Feed-in terminals	12/17, 12/23, 12/25
Circuit-breaker terminals for auxiliary circuits	12/46	Fuse system	19/32 ... 19/34	for neutral busbar	12/33
Coding elements	12/27	SITOR	19/40, 19/41	Female multipoint connectors	12/27
Communications modules	2/36, 2/37			Filter fans	14/30
Compact starters	6/56 ... 6/58	D		Fixing parts	12/60
Connecting combs	12/7, 12/10, 12/40	DC UPS modules	11/13	Flat connector	12/38
Connecting leads	5/48	Device identification labels	12/36, 12/50	Flat-type terminals	12/37
Connection for LOGO!	2/41	DIAZED		Floor mounting	
Contactors assemblies		Fuse bases	19/17 ... 19/21	3LD main and EMERGENCY-STOP	
Reversing contactor assemblies	3/38 ... 3/45, 3/54	Fuse links	19/15, 19/16	switches up to 125 A	17/20 ... 17/23
- Complete units	3/38 ... 3/42	- SILIZED	19/43	Switch disconnectors	17/5 ... 17/9
- Components		Fuse system	19/15 ... 19/21	Front covers, accessories	14/54
for customer assembly	3/43 ... 3/45	Digital measuring devices	19/122	Front mounting	
Wye-delta assemblies	3/55	Diode terminals	12/21, 12/40	3LD main and EMERGENCY-STOP	
- Complete units	3/46 ... 3/52	Direct-on-line starters 6/24 ... 6/31, 6/121 ... 6/122		switches up to 125 A	17/15 ... 17/19
- Components for customer assembly	3/53	Encapsulated	6/122	Switch disconnectors with fuses	17/35
Contactors relays	3/78 ... 3/89	for busbar systems	6/28 ... 6/31, 6/63 ... 6/64	Front plates	5/2
with auxiliary switch block	3/79, 3/80	for snapping onto a standard mounting rail	6/24 ... 6/27	Accessories	5/28 ... 5/30
Coupling relays		or for screw mounting		Function expansion modules	5/47
- for switching auxiliary circuits	3/88, 3/89	Disconnecting link	12/38	Function modules	4/17 ... 4/24
Contactors		Distance protection	5/13	Fuse bases	
for special applications		Distance protection, voltage transformer circuit-breakers	5/2	Cylindrical	19/33, 19/34
- Capacitor contactors	3/66	Distance sleeves	12/38, 12/49	DIAZED	19/17 ... 19/21
- for switching DC voltage	3/75 ... 3/77	Door-coupling rotary mechanisms	5/2	NEOZED	19/6 ... 19/10
- for switching resistive loads	3/56 ... 3/61	Door-coupling rotary operating mechanisms	5/22 ... 5/23, 14/104 ... 14/115	Fuse disconnectors NEOZED	19/11
- with extended operating range, for railway applications	3/67 ... 3/74	for circuit-breakers	14/110 ... 14/113		
for switching motors	3/4 ... 3/37	for switch disconnectors	14/106 ... 14/109		
- Vacuum contactors	3/30 ... 3/33	Individual parts	14/114		
- with auxiliary switch block	3/12 ... 3/24, 3/36	Operating mechanisms			
- with DC solenoid system	3/34	for fixed mounting	14/115		

Appendix

Subject index

	Page		Page		Page
Fuse links		I		Link rails	12/36, 12/38, 12/47
American/Canadian	19/46	I/O modules		Linking accessories	12/24
Cylindrical		for use in the control cabinet	2/32 ... 2/41	Load feeders	4/5
- for motor circuits	19/45	- F90 module	2/35	Fuseless	6/23 ... 6/49
- SITOR	19/40, 19/41	- Flat module	2/35	Module	6/10
Cylindrical fuses	19/32	- SlimLine	2/33, 2/34	- AS-Interface	6/61 ... 6/62
DIAZED	19/15, 19/16	for use in the field		with safety integrated	6/50 ... 6/55
LV HRC		- analog	2/30, 2/31	Load monitoring	4/23
- for motor circuits	19/44	- digital	2/22 ... 2/29	Lockouts	12/17, 12/23, 12/25
NEOZED	19/5	Infeed system	6/46 ... 6/49	LOGO!	
SILIZED	19/43	Initiator/actuator terminals	12/26	AS-Interface connection	2/41
SITOR	19/35 ... 19/41	Insta terminals	12/22, 12/35	CM EIB/KNX communications module	7/24
for special applications		Insulated three-phase busbar systems	5/2	Contact	7/26
- SITOR	19/42	Insulation carriers	12/36, 12/60	Modular basic variants	7/18, 7/19
Fuse monitoring	5/2, 5/11	Insulation monitoring		Modular extension modules	7/22, 7/23
Fuse switch disconnectors		for ungrounded AC networks	7/52	Modular pure variants	7/20, 7/21
3NJ4, 3NJ5 in-line version, up to 1250 A	17/66 ... 17/69	for ungrounded DC voltage networks	7/53	Software	7/27
3NP up to 630 A	17/46 ... 17/65	Insulation plates	12/25, 12/38	LOGO! Logic Modules	7/17 ... 7/27
Assembly kits for distribution boards	17/55 ... 17/57	Insulation stop	12/27	LOGO!Power	11/9
for extended technical requirements	17/58 ... 17/65	for conductors	12/25	LV HRC	
for extended technical requirements with fuse monitoring	17/60 ... 17/63	Interface modules	6/77 ... 6/87	Bases	19/28 ... 19/31
for power distribution	17/47 ... 17/49	Interface, DP/AS	2/19, 2/20	Fuse links	19/22 ... 19/27
for power distribution with fuse monitoring	17/50 ... 17/52	Isolating terminals	12/40	- for motor circuits	19/44
Fuse terminals	12/19, 12/42	Isolating transformers 10/5 ... 10/48, 10/57 ... 10/62		- SITOR	19/35
Fuseless load feeders	6/23 ... 6/49	Isolator modules	5/2, 5/17	Fuse system	19/22
Direct-on-line starters				Signal detectors	19/31
- for busbar systems	6/28 ... 6/31				
- for snapping onto standard mounting rail or for screw mounting	6/24 ... 6/27	J		M	
Infeed system	6/46 ... 6/49	Jumper plugs	12/40	Magnetic coils	3/126 ... 3/129, 3/142, 3/144
Reversing starters				Mains transformers	10/5 ... 10/48, 10/57 ... 10/62
- for busbar systems	6/36 ... 6/39			Marshalling boxes,	
- for snapping onto standard mounting rail or for screw mounting	6/32 ... 6/35			Surface-mounting design	14/39
Fuse links				Masters	
LV HRC	19/22 ... 19/27	L		CP 243-2	2/17
Fuses		Label holders	12/25, 12/33, 12/58	CP 243-2 P	2/18
Class CC	19/46	for identification of wires	12/58	Matching transformers	10/50, 10/64, 10/73, 10/84, 10/85
Cylindrical	19/32 ... 19/34	Labeling accessories	12/50	with cURus Approval	10/74 ... 10/83
DIAZED	19/15 ... 19/21	Labeling plates	12/50	with selectable voltages	10/84, 10/85
LV HRC	19/22 ... 19/31	Customized inscriptions	12/57	Measuring instruments	19/118 ... 19/130
NEOZED	19/4 ... 19/14	for individual wires	12/50	Analog	19/122
Semiconductor	19/35 ... 19/41	Type 1	12/51	Current transformers	19/129
		Type 2	12/52	Digital	19/122
		Type 3a	12/53	E-counters	19/125 ... 19/127
		Type 3b	12/54	LAN couplers	19/128
		Type 3c	12/55	Measuring selector switches	19/128
		Type 3d	12/56	Multicounters	19/124
		without inscription	12/57	Multimeters	19/123
G		Labeling plates for wires	12/58	Pulse counters	19/120
Ground fault detection modules	2/39	Labeling plates, without inscription	6/9	Time counters	19/120
Group labels	12/25, 12/58	Labels	4/5, 12/60	- for front mounting	19/121
		LAN couplers	19/128	Measuring selector switches	19/128
H		LED module		Measuring transformer terminals	12/44
Heat exchangers	14/32	for indicating contactor operation	3/122	Mechanical RESET	5/49, 5/55
Heaters	14/33	Level monitoring	7/54, 7/55	Miniature circuit-breakers	19/52 ... 19/82
Heating current monitoring	4/23	Lightning arresters	19/109, 19/110	Accessories	19/77 ... 19/80
Heating fans	14/33	Combination arresters	19/110	AC/DC product range	19/70
Holding blocks	12/49	Line monitoring	7/43 ... 7/46		
		Link modules	5/2, 5/26, 6/9, 6/42, 6/44		

	Page		Page		Page
Additional components	19/54, 19/72 ... 19/76	N		R	
High-capacity product range	19/60 ... 19/69	NEOZED		RC socket outlets	19/105, 19/106
High-current product range	19/71	Fuse bases	19/6 ... 19/10	RC units for miniature circuit-breakers	19/72, 19/73, 19/102 ... 19/104
Power supply company product range	19/81 ... 19/82	Fuse disconnectors	19/11	Reduction plugs	12/40, 12/59
RC units	19/72, 19/73	Fuse links	19/5	Reduction sleeve	12/7, 12/8
RCCB modules	19/102 ... 19/104	- SILIZED	19/43	Redundancy module	11/11
Standard product range	19/53 ... 19/59	Fuse system	19/4 ... 19/14	Relay couplers	3/95, 3/96, 3/101 ... 3/105
MINIZED		Neutral busbar ends	12/17, 12/23, 12/25	Relays	
Switch disconnectors	19/12 ... 19/14	Neutral busbar supports	12/17, 12/23, 12/25	Analog adjustable	7/57 ... 7/59
Miscellaneous accessories	12/25	Neutral busbars	12/17, 12/25, 12/33, 12/36	Digital adjustable	
Modular power supplies	11/11	Neutral isolating terminals	12/17, 12/23, 12/33	- acc. to DIN 3440	7/60 ... 7/62
Molded-plastic enclosure		Non-stabilized power supplies		- for up to 3 sensors	7/63, 7/64
3LD main and EMERGENCY-STOP switches up to 125 A	17/26, 17/27	Filtered	11/3 ... 11/6	Remote motorized operating mechanisms	5/2, 5/22 ... 5/23
Switch disconnectors	17/10	Single-phase	11/3, 11/4, 11/7	Remote RESET	5/55
Monitoring devices	7/1 ... 7/84	Three-phase	11/5, 11/6, 11/8	Residual current operated circuit-breakers	
Monitoring relays for electrical and additional measurements		Unfiltered	11/7, 11/8	RC units for miniature circuit-breakers	19/72, 19/73
Current monitoring	7/49, 7/50	O		Residual current protective devices	19/83 ... 19/107
Insulation monitoring	7/52, 7/53	OFF-delay devices	3/136, 3/140	Leakage current measurement unit	19/94
Level monitoring	7/54, 7/55	Operating devices	12/27	RC socket outlets	19/105, 19/106
Line monitoring	7/43 ... 7/46	Overvoltage protection module	2/39, 2/40	RC units for miniature circuit-breakers	19/102 ... 19/104
Power factor monitoring	7/51	P		RCCBs	19/95 ... 19/97
Speed monitoring	7/56	PE terminals	12/8, 12/11, 12/18, 12/34	- Additional components/accessories	19/98 ... 19/101
Voltage monitoring	7/47, 7/48	PE/ground identification	12/27	- with integral overcurrent protection (RCCBs)	19/96
Motor contactors	3/69 ... 3/73	PEN terminals	12/34	Residual current operated circuit-breakers	19/84 ... 19/90
Motor management and control devices		Pillar-type variable-ratio transformers	10/2, 10/3	- (RCCBs)	19/84 ... 19/89
SIMOCODE pro 3UF7	7/5 ... 7/16	Planning, design and management with SIMARIS	18/1 ... 18/6	- (RCCBs) SIQUENCE	19/90
Motor protection	5/2, 5/5 ... 5/7	Plant protection	5/2	- Additional components/accessories	19/91 ... 19/94
Motor protection and control devices		Plant protection according to UL	5/12	Retaining plates	12/25
SIMOCODE-DP 3UF5	7/11 ... 7/14	Plug connectors	12/27	Reversing contactor assemblies	3/38 ... 3/42
Motor protection with overload relay function	5/2, 5/8	Plug-in relays, relay couplers	3/102 ... 3/105	Reversing starters	6/32 ... 6/39, 6/124
Motor starters	6/59 ... 6/60	Power controllers	4/24	Encapsulated	6/123
ET 200pro	6/98 ... 6/108	Power distribution boards	14/7 ... 14/10	for busbar systems	6/65 ... 6/66
- High Feature	6/98, 6/99	8P	14/9, 14/10	for snapping onto a standard mounting rail or for screw mounting	6/32 ... 6/35
- Isolator modules	6/100	8PV	14/8	Rotary operating mechanisms	5/22 ... 5/23
- Safety modules local	6/101	Power modules for ET 200S motor starters	6/73	Routers, DP/AS-Interface	2/19, 2/20
- Standard	6/98, 6/99	Power relays/minature contactors	3/106	S	
ET 200S	6/67 ... 6/87	Power supplies	11/1 ... 11/14	Safety modules Local	6/91 ... 6/94
- Power modules	6/73	Filtered	11/3 ... 11/6	Safety modules PROFIsafe	6/95 ... 6/97
- Terminal modules	6/74 ... 6/76	LOGO!Power	11/9	Safety transformers	10/5 ... 10/48, 10/57 ... 10/62
ET 200S failsafe	6/89 ... 6/90	Modular	11/11	Resin-enclosed	10/51, 10/52
ET 200X	6/109 ... 6/114	Non-stabilized	11/3 ... 11/8	Screwdrivers	12/25, 12/27
- Basic modules	6/113 ... 6/115	Single-phase	11/3, 11/4, 11/7	Sealable covers	5/50
- Expansion modules	6/113 ... 6/115	SITOP	11/11, 11/13, 11/14	Semiconductor couplers	3/99, 3/100
Motor starters and load feeders		SITOP power	11/10 ... 11/13	Semiconductor fuses	
IP20	6/61 ... 6/66	Stabilized	11/9, 11/11, 11/13, 11/14	SILIZED	19/43
IP65/67	6/56 ... 6/60	Three-phase	11/5, 11/6, 11/8	SITOR	19/35 ... 19/41
Motor starters and soft starters		Unfiltered	11/7, 11/8	Series of switchgear cubicles, SIKUS	14/35
AS-Interface	6/56 ... 6/66	Uninterruptible	11/13, 11/14	Shield terminals	12/49
ECOFAS	6/120	Power supply units AS-Interface	2/42 ... 2/44	Shunt releases	5/2, 5/18
Mounting accessories	12/59	Power transformers	10/49, 10/50, 10/63 ... 10/85		
Mounting brackets	12/60	with selectable voltages	10/49, 10/50, 10/61, 10/62, 10/84, 10/85		
Mounting rails	12/49	PROFIBUS	2/60 ... 2/69		
Multicounters	19/124	Push-in lugs	5/50		
Multimeters	19/123				

Appendix

Subject index

	Page		Page		Page
Signal detectors, LV HRC	19/31	Special integrated solutions		Switch disconnectors	
Signaling module	11/11	- Communications modules	2/36, 2/37	3KA	17/5
SIKUS, series of switchgear cubicles	14/35	User modules	2/29	3KE	17/10
SILIZED				Floor mounting	17/5 ... 17/9
Fuse links	19/43	Sliding-link terminals	12/22	Fuse switch, 3NP up to 630 A	17/46 ... 17/65
Semiconductor fuses	19/43			MINIZED	19/12 ... 19/14
SIMARIS		Snapping onto busbars		Molded-plastic enclosure	17/10
Design	18/1 ... 18/6	Switch disconnectors with fuses and isolating plug connector	17/40		
Management	18/1 ... 18/6	Socket outlets	19/115, 19/117	Switch disconnectors with fuses	
Planning	18/1 ... 18/6	Soft starters	6/2, 6/4 ... 6/21	3KL up to 800 A	17/32 ... 17/38
SIMARIS design	18/3	for High Feature applications	6/15 ... 6/21	3NJ6 up to 630 A, in-line	17/43 ... 17/45
SIMARIS manager	18/5, 18/6	- Box terminal block	6/19	Double-break	17/45
SIMOCODE		- Covers	6/19	Double-break with fuse monitoring	17/45
-DP 3UF5	7/11 ... 7/14	- Fans	6/19	Front mounting	17/35
pro 3UF7	7/5 ... 7/16	for standard applications	6/5 ... 6/14	Single-break	17/44
Single-phase power supplies		- Box terminal block	6/13	Single-break with fuse monitoring	17/44
Filtered	11/3, 11/4	- Covers	6/13	Surface mounting and installation	17/33, 17/34
Unfiltered	11/7	- Fans	6/13		
Single-phase transformers	10/5 ... 10/48	- Modules for RESET	6/13	Switch disconnectors with fuses and isolating plug connector	
Autotransformers	10/47, 10/48, 10/50	Soft starters for standard applications		3KM up to 400 A	17/39 ... 17/42
Control transformers	10/5 ... 10/48	Covers	6/8	for snapping onto busbars	17/40
Converter transformers	10/50	Fans	6/8	Switch ES Power	18/4
Isolating transformers	10/5 ... 10/48	Soldering tags	12/38		
Mains transformers	10/5 ... 10/48	Soldering terminal	5/24, 5/25	System components and accessories	
Matching transformers	10/50	Solid-state contactors	4/11 ... 4/16	Accessories	2/51 ... 2/52
Power transformers	10/49, 10/50	3RF23	4/12 ... 4/16	Addressing unit	2/47
Safety transformers	10/5 ... 10/48	Solid-state modules	6/77 ... 6/87	Analyzer	2/48, 2/50
Variable-ratio transformers	10/2	Solid-state overload relays	5/35 ... 5/50	Extension plug	2/46
Voltage regulators		3RB20	5/38 ... 5/41, 5/43		
- Solenoid-type	10/56	3RB21	5/42	System cubicles	
- Transformer-type	10/55	for High-Feature applications	5/44 ... 5/48	SICUBE	
		for standard applications	5/35 ... 5/43	- Cubicle air-conditioning	14/30 ... 14/34
SIQUENCE		Solid-state relays	4/6	- Non-ventilated	14/21 ... 14/29
RCBOs	19/95	3RF20	4/10		
Residual current operated circuit-breakers	19/90	3RF21	4/7 ... 4/9	T	
SIRIUS		Spacer brackets	12/60	Temperature monitoring relays	
Modular system	2/70 ... 2/72	Spacers	12/60	3RS10, 3RS11	7/57 ... 7/64
Safety integrated	2/56 ... 2/59	Speed monitoring	7/56	Terminal brackets	5/49, 5/55
SIRIUS SC solid-state switching devices	4/3	SR60 busbar system	19/47 ... 19/51	Terminal covers	5/50, 5/55
SITOP		Stabilized power supplies		Terminal modules for ET 200S motor starters	6/74 ... 6/76
LOGO!Power	11/9	LOGO!Power	11/9	Terminal strip	12/48
power	11/9 ... 11/14	SITOP	11/9, 11/11, 11/13, 11/14	Terminal strip labels	12/58
Uninterruptible	11/13, 11/14	Standard mounting rail	12/59	Terminals	
SITOP power	11/9 ... 11/14	Standard mounting rail adapters	6/10, 6/43, 6/44	Bolt-type	12/37
SITOP select	11/12	Starter combinations	5/2, 5/9	Branch	12/33
Diagnostics modules	11/12	Starters, encapsulated	6/121 ... 6/124	Circuit-breakers for auxiliary circuits	12/46
SITOR		Surface mounting and installation		Diode	12/21, 12/40
for special applications	19/42	for extended technical requirements with fuse monitoring by circuit-breaker	17/58, 17/60	Feed-in	12/17, 12/23, 12/25, 12/47
Semiconductor fuses	19/35 ... 19/41	for extended technical requirements with fuse monitoring by electronic circuit-breaker	17/62	Feed-in for neutral busbar	12/33, 12/36
SIVACON motor control centers	14/7 ... 14/10	for power distribution	17/47	Flat-type	12/37
8PT	14/9, 14/10	for power distribution with fuse monitoring by circuit-breaker	17/50	for components	12/20, 12/41
8PV	14/8	Switch disconnectors with fuses	17/33, 17/34	Fuse	12/19, 12/42
Slaves		Surface-mounting distribution boards	14/37 ... 14/39	Initiator/actuator	12/26
Connection for LOGO!	2/41	Surge arresters	19/111 ... 19/116	Insta	12/22, 12/35
I/O modules		Surge suppressors	3/134, 3/137, 3/139, 3/141, 6/10, 6/41	Isolating	12/40
- for use in the control cabinet	2/32 ... 2/35	without LED	3/119, 3/120	Measuring transformer	12/44
- for use in the field	2/21 ... 2/31			Neutral isolating	12/17, 12/23, 12/33
Modules with special functions				PE	12/8, 12/11, 12/18, 12/34
- Counter modules	2/38			PEN	12/34
- Ground fault detection modules	2/39			Shield	12/49
- Overvoltage protection module	2/39, 2/40			Sliding-link	12/22

	Page		Page		Page
Terminals for "Self-Protected Combination Motor Controller (Type E)" according to UL508	5/24, 5/25	Transmission media, shaped cable	2/45	V	
Test adapter	12/7, 12/8, 12/10	Two-tier terminals	12/16, 12/38, 12/39	Vacuum contactors	3/30 ... 3/33
Test plugs	12/40, 12/59			Variable-ratio transformers	
Test socket	12/38, 12/59	U		Pillar-type variable-ratio transformers	10/2, 10/3
Thermal overload relays	5/51 ... 5/55	Undervoltage releases	5/2, 5/18	Toroidal-core variable-ratio transformers	10/2, 10/3
3RU11	5/52 ... 5/54	Unequipped cubicles		Voltage converter circuit-breakers	5/13
for standard applications	5/51 ... 5/54	Accessories	14/50, 14/51	Voltage monitoring	7/47, 7/48
Thermostats	14/34	Assembly kits for	14/40 ... 14/49	Voltage regulators	
Three-phase busbar system	5/19 ... 5/21	Surface mounting design	14/37, 14/38	Solenoid-type	10/56
Three-phase power supplies		Uninterruptible power supplies	11/13, 11/14	Transformer-type	10/55, 10/88
Filtered	11/5, 11/6	Unit labeling plates	4/5	W	
Unfiltered	11/8	User modules	2/29	Withdrawable coils	3/130 ... 3/132
Three-phase transformers	10/57 ... 10/62			Wye-delta assemblies	3/46 ... 3/53
Autotransformers	10/61, 10/62				
- for matching purposes	10/86, 10/87				
Control transformers	10/57 ... 10/62				
Isolating transformers	10/57 ... 10/62				
Mains transformers	10/57 ... 10/62				
Matching transformers	10/64 ... 10/84				
- with cURus approval	10/74 ... 10/83				
- with selectable voltages	10/84				
Power transformers	10/63 ... 10/85				
Safety transformers	10/57 ... 10/62				
Transformers with selectable voltages	10/61, 10/62				
Variable-ratio transformers	10/3				
Voltage regulators	10/88				
Three-tier terminals	12/22, 12/35				
Through-type terminals	12/7, 12/9, 12/14, 12/30, 12/43				
Time counters	19/120				
for front mounting	19/121				
Time-delay blocks, solid-state	3/118				
Toroidal-core variable-ratio transformers	10/2, 10/3				
Transformer protection	5/2, 5/10				
Transformer terminals	12/48				
Transformers	10/1 ... 10/88				
Autotransformers	10/47, 10/48, 10/50, 10/61, 10/84, 10/85				
- for matching purposes	10/86, 10/87				
Control transformers	10/5 ... 10/48, 10/57 ... 10/62				
Converter transformers	10/50, 10/84, 10/85				
Enclosed transformers	10/51, 10/52				
Isolating transformers	10/48, 10/57 ... 10/62				
Mains transformers	10/5 ... 10/48, 10/57 ... 10/62				
Matching transformers	10/50, 10/64, 10/73				
- with cURus approval	10/74 ... 10/83				
- with selectable voltages	10/84, 10/85				
Power	10/50				
Power transformers	10/49, 10/63 ... 10/85				
Safety transformers	10/5 ... 10/48, 10/51, 10/52, 10/57 ... 62				
Three-phase transformers	10/57 ... 10/88				
Variable-ratio	10/2, 10/3				
Voltage regulators					
- Solenoid-type	10/56				
- Transformer-type	10/55, 10/88				
with selectable voltages	10/49, 10/50, 10/61, 10/62, 10/84, 10/85				
Transformers					
Isolating transformers	10/5 ... 10/48				

Appendix

Order number index

Order No.	Page	Order No.	Page	Order No.	Page
3		3LD2 72	17/19	3RA13	3/39 ... 42
3KA	17/5	3LD2 73	17/24 ... 25	3RA14	3/48 ... 52
3KE	14/65, 17/7 ... 9	3LD2 76	17/26 ... 27	3RA19 0	6/43
3KL	17/33 ... 34	3LD2 80	17/15 ... 16	3RA19 11	5/26 ... 27, 6/9, 6/42, 6/44
3KM	17/40	3LD2 81	17/20 ... 22	3RA19 12	3/45
3KX2	17/7, 17/12 ... 13	3LD2 83	17/24 ... 25	3RA19 13	3/44 ... 45, 3/53, 6/42, 6/45
3KX3 1	17/11, 17/37, 17/42	3LD2 86	17/26	3RA19 21	5/26, 6/9, 6/42
3KX3 50	17/36 ... 37, 17/41 ... 42	3LD9 200	17/16 ... 18, 17/21 ... 22, 17/24 ... 26, 17/28 ... 31	3RA19 22	3/45, 5/27, 6/10, 6/43 ... 44
3KX3 51	17/6, 17/11, 17/35 ... 36, 17/41	3LD9 201	17/28	3RA19 23	3/43 ... 45, 3/53, 6/42 ... 43, 6/45
3KX3 52	17/35 ... 36, 17/41	3LD9 220	17/17 ... 18, 17/20 ... 22, 17/24 ... 26, 17/29	3RA19 24	3/43, 6/42
3KX3 53	17/6, 17/11, 17/35 ... 36, 17/41	3LD9 221	17/29	3RA19 31	5/26, 6/9, 6/42
3KX3 552	17/11, 17/36 ... 37, 17/41 ... 42	3LD9 224	17/28 ... 29	3RA19 32	3/45, 3/53, 6/43
3KX3 553	17/11, 17/36, 17/41	3LD9 250	17/15 ... 16, 17/20 ... 22, 17/24 ... 26, 17/30	3RA19 33	3/44 ... 45, 3/53, 6/42 ... 43, 6/45
3KX3 556	17/6, 17/35	3LD9 251	17/30	3RA19 4	5/26, 6/9, 6/42 ... 43
3KX3 557	17/11 ... 12, 17/37, 17/42	3LD9 280	17/15 ... 16, 17/20 ... 22, 17/24 ... 26, 17/31	3RA19 5	3/43 ... 45, 3/53
3KX3 56	17/38	3LD9 281	17/31	3RA19 6	3/43 ... 45, 3/53
3KX3 6	17/38	3LD9 284	17/30 ... 31	3RA19 7	3/43 ... 44, 3/53
3KY	17/12 ... 13	3LD9 286	17/28 ... 31	3RA5	6/64 ... 65
3LD2 00	17/15 ... 16	3NA	19/23 ... 27	3RA7	6/51 ... 55
3LD2 01	17/20 ... 21, 17/23	3NC	19/35, 19/40 ... 42	3RB1	5/25, 6/44, 7/10, 7/14
3LD2 02	17/17	3ND	19/44	3RB20	5/38 ... 41
3LD2 03	17/24 ... 25	3NE	19/35 ... 39, 19/42	3RB21	5/42 ... 43
3LD2 04	17/20, 17/22	3NG1	19/31	3RB22	5/47
3LD2 05	17/15 ... 16, 17/18	3NH	19/28 ... 29, 19/50	3RB23	5/47
3LD2 06	17/26	3NJ	17/44 ... 45, 17/67 ... 69	3RB29	5/47 ... 50
3LD2 10	17/15 ... 16, 17/19	3NP40 1	14/88, 14/100, 17/47 ... 49, 19/50	3RE	6/122 ... 124
3LD2 11	17/20 ... 21, 17/23	3NP40 70	17/47, 17/50	3RF20	4/10
3LD2 12	17/17, 17/19	3NP40 75	14/88 ... 89, 17/48, 17/51	3RF21	4/7 ... 9
3LD2 13	17/24 ... 25	3NP40 76	14/100 ... 101, 17/49, 17/52, 19/50	3RF23	4/12 ... 16
3LD2 14	17/20, 17/22	3NP42 70	17/47, 17/50	3RF29	4/9, 4/16, 4/22 ... 24
3LD2 15	17/15 ... 16, 17/18	3NP42 75	14/88 ... 89, 17/48, 17/51	3RG	2/35, 2/37, 2/52
3LD2 16	17/26 ... 27	3NP42 76	14/100 ... 101, 17/49, 17/52, 19/50	3RH11	3/67, 3/79 ... 80, 3/88 ... 89
3LD2 20	17/15 ... 16, 17/19	3NP43	14/100 ... 101, 17/47, 17/49 ... 50, 17/52, 19/50	3RH12	3/79 ... 80
3LD2 21	17/20 ... 21, 17/23	3NP44	14/100 ... 101, 17/47, 17/49 ... 50, 17/52, 19/50	3RH14	3/82
3LD2 22	17/17, 17/19	3NP5	17/58 ... 63	3RH19 1	3/110 ... 111, 3/113, 3/115 ... 116, 6/40
3LD2 23	17/24 ... 25	3NW	19/32 ... 33, 19/45 ... 46, 19/50	3RH19 21	3/110 ... 112, 3/114 ... 116, 6/40
3LD2 24	17/20, 17/22	3NX	19/30 ... 31	3RH19 24	3/122
3LD2 25	17/15 ... 16, 17/18	3NY	17/53 ... 57, 17/64 ... 65	3RK1 1	2/14, 2/22, 2/27, 2/31, 2/34
3LD2 26	17/26 ... 27	3RA11 10	6/24 ... 31	3RK1 2	2/16, 2/22, 2/27, 2/31, 2/34, 2/37 ... 38
3LD2 50	17/15 ... 16, 17/19	3RA11 20	6/24 ... 31	3RK1 30	6/69 ... 70, 6/90, 6/99 ... 101, 6/120
3LD2 51	17/20 ... 21, 17/23	3RA11 3	6/24, 6/26	3RK1 32	6/57, 6/120
3LD2 52	17/19	3RA12 10	6/32 ... 39	3RK1 400	2/22, 2/26 ... 27, 2/34 ... 35, 2/37, 2/41, 6/10, 6/60, 6/62, 7/25
3LD2 53	17/24 ... 25	3RA12 20	6/32 ... 39	3RK1 402	2/34, 6/10, 6/62
3LD2 54	17/20, 17/22			3RK1 405	2/16
3LD2 55	17/15 ... 16			3RK1 408	2/39
3LD2 56	17/26 ... 27			3RK1 7	2/31, 6/10, 6/58, 6/66
3LD2 70	17/15 ... 16			3RK1 8	2/14
3LD2 71	17/20 ... 22				

Appendix

Order number index

Order No.	Page	Order No.	Page	Order No.	Page
3RK1 901	2/14, 2/16, 2/23, 2/26, 2/28, 2/31, 2/40, 2/46 ... 47, 2/51 ... 52, 6/10, 6/66, 6/110	3RT19 22	3/45	3RX9 0	2/45
3RK1 902	2/23, 2/28, 2/31, 6/58, 6/102, 6/111 ... 112, 6/115, 6/119	3RT19 24	3/126 ... 127	3RX9 3	2/42
3RK1 903	6/70 ... 71, 6/73, 6/75 ... 76, 6/90, 6/93 ... 94, 6/97	3RT19 26	3/53, 3/117 ... 120, 3/122 ... 124, 6/41, 7/39 ... 40	3RX9 5	2/43
3RK1 904	2/47, 2/50	3RT19 34	3/126 ... 129, 3/133	3RX9 801	2/46, 2/50 ... 51
3RK1 91	6/102	3RT19 35	3/126 ... 127, 3/133	3RX9 802	6/57, 6/102, 6/104, 6/106 ... 107, 6/114 ... 117
3RK1 92	6/102	3RT19 36	3/53, 3/120, 3/123 ... 124, 3/133, 5/24, 5/50, 5/55, 6/8, 6/41	3RX9 805	2/51
3RK110	2/14	3RT19 44	3/128 ... 129, 3/133	3RX9 806	2/51
3RK19	3/121	3RT19 45	3/128 ... 129, 3/133	3RX9 807	2/51
3RK2	2/22, 2/27, 2/34	3RT19 46	3/53, 3/122 ... 124, 3/133, 5/24 ... 25, 5/50, 5/55, 6/8	3RX9 808	2/51
3RN	7/64 ... 65	3RT19 54	3/133	3RX9 81	2/35, 2/51
3RP15	7/29 ... 32	3RT19 55	3/124, 3/130 ... 133, 5/50, 6/13, 6/19	3SB10	9/26
3RP19	2/14, 2/34, 6/8, 7/10	3RT19 56	3/53, 3/120, 3/123 ... 124, 3/133, 5/50, 6/13, 6/19	3SB14	9/29, 17/11, 17/36 ... 37, 17/41 ... 42
3RP19 01	7/33, 7/37	3RT19 64	3/133	3SB19 01	9/69, 9/73, 9/100
3RP19 02	7/33, 7/44, 7/46, 7/48, 7/74	3RT19 65	3/130 ... 133	3SB19 02	9/78 ... 81, 9/83, 9/101
3RP19 03	7/33, 7/44, 7/46, 7/48, 7/60, 7/62, 7/66, 7/74	3RT19 66	3/53, 3/121, 3/123 ... 124, 3/130, 3/132 ... 133, 5/50, 6/13, 6/19	3SB19 04	9/75
3RP2	7/35 ... 36	3RT19 7	3/130 ... 133	3SB19 06	9/29, 9/74
3RS10	7/56 ... 57, 7/59 ... 60, 7/62	3RU	5/49, 5/52 ... 55, 6/13	3SB19 1	9/79
3RS11	7/56 ... 57, 7/59 ... 60	3RV10	5/7	3SB20	9/7 ... 8
3RS17	7/81 ... 82	3RV11	5/8	3SB22	9/5 ... 6
3RS18	3/101	3RV13	5/9	3SB23	9/9
3RS19	7/60, 7/62	3RV14	5/10	3SB24	9/9 ... 10
3RS2	7/59 ... 60	3RV16	5/11, 5/13	3SB29 01	9/11 ... 15
3RT10 15	3/12 ... 13, 3/20 ... 21, 3/90 ... 93	3RV17	5/12	3SB29 02	9/15, 9/17
3RT10 16	3/12 ... 13, 3/20 ... 21, 3/90 ... 93	3RV19 0	5/11, 5/13, 5/16, 5/18, 5/24, 5/30, 6/40	3SB29 08	9/9 ... 10, 9/16 ... 17, 9/79
3RT10 17	3/12 ... 13, 3/20 ... 21, 3/70, 3/90 ... 93	3RV19 12	5/18	3SB29 1	9/16
3RT10 23	3/14 ... 15, 3/22 ... 23	3RV19 13	5/29 ... 30	3SB30 00	5/49, 5/55, 6/13, 9/26, 9/30 ... 37
3RT10 24	3/14 ... 15, 3/22 ... 23, 3/94	3RV19 15	3/53, 5/20 ... 21	3SB30 01	9/30 ... 32, 9/37
3RT10 25	3/14 ... 15, 3/22 ... 23, 3/70 ... 72, 3/94	3RV19 17	6/48 ... 49	3SB31	9/38, 9/41 ... 45
3RT10 26	3/14 ... 15, 3/22 ... 23, 3/70 ... 72, 3/94	3RV19 18	5/25	3SB32	9/20 ... 26
3RT10 3	3/16 ... 17, 3/24 ... 25, 3/70 ... 72	3RV19 21	5/17	3SB33	9/39 ... 40
3RT10 4	3/18 ... 19, 3/24 ... 25, 3/70 ... 72	3RV19 22	5/18	3SB34	9/61 ... 64, 9/97 ... 98, 16/41
3RT10 5	3/26 ... 28	3RV19 23	5/29 ... 30	3SB35 00	9/51 ... 59
3RT10 6	3/26 ... 28	3RV19 25	5/20 ... 21	3SB35 01	9/51 ... 55, 9/60
3RT10 7	3/26 ... 28	3RV19 26	5/20 ... 21, 5/23, 5/29	3SB36	9/46 ... 50
3RT12	3/30	3RV19 27	6/48 ... 49	3SB38	9/85 ... 88, 9/104
3RT13	3/58 ... 60	3RV19 28	5/17, 5/25	3SB39 01	9/16, 9/64, 9/68, 9/78 ... 79, 9/82 ... 83, 9/97 ... 98, 9/101, 9/104
3RT14	3/56 ... 57	3RV19 3	3/53, 5/17, 5/20 ... 21, 5/23, 5/29	3SB39 02	9/68, 9/72
3RT15	3/64 ... 65	3RV19 4	5/23	3SB39 03	9/68, 9/74
3RT16	3/66	3RW2	7/14	3SB39 05	9/68, 9/75
3RT19	6/107	3RW3	6/6 ... 8	3SB39 06	9/68, 9/99
3RT19 00	3/125, 4/5, 5/50, 5/56, 6/9, 7/33, 7/37, 7/44, 7/46, 7/48, 7/57, 7/60, 7/62, 7/66	3RW4	6/12 ... 13, 6/16 ... 19	3SB39 1	9/79
3RT19 16	3/53, 3/117 ... 125, 3/138, 6/41, 7/39 ... 40	3RX1 5	8/42	3SB39 21	9/38, 9/77, 9/80 ... 83, 9/101
		3RX1 6	6/57, 6/107, 6/110, 6/114 ... 117	3SB39 22	9/38, 9/73
		3RX8	2/47, 2/50	3SB39 23	9/74

Appendix

Order number index

Order No.	Page	Order No.	Page	Order No.	Page
3SE2 10	8/21 ... 26, 8/52	3TE	3/55	3VL47 40	16/6 ... 11, 16/17, 16/20 ... 21, 16/24 ... 27, 16/33
3SE2 120	8/21 ... 30, 8/47, 8/52	3TF	3/32, 3/35 ... 36	3VL57 31	16/6 ... 7, 16/10 ... 11, 16/20 ... 21, 16/24 ... 25
3SE2 200	8/5 ... 11, 8/45, 8/60	3TG	3/106	3VL57 4	16/6 ... 7, 16/20 ... 21, 16/24 ... 25
3SE2 21	8/5 ... 7, 8/10	3TH	3/68, 3/83 ... 84, 3/86 ... 87	3VL57 50	16/6 ... 11, 16/20 ... 21, 16/24 ... 25
3SE2 23	8/13 ... 18	3TK1	3/61, 3/145	3VL57 63	16/6 ... 11, 16/17, 16/20 ... 21, 16/24 ... 27, 16/33
3SE2 24	8/46	3TK2	3/62, 7/70, 7/72 ... 74, 7/76 ... 77	3VL67 80	16/8 ... 11, 16/17, 16/26 ... 27, 16/33
3SE2 25	8/46	3TX2	3/144	3VL77 10	16/8 ... 9, 16/26 ... 27
3SE2 28	8/60	3TX4 0	3/139	3VL77 12	16/8 ... 11, 16/17, 16/26 ... 27, 16/33
3SE2 3	8/31 ... 34	3TX4 1	3/139	3VL87 16	16/8 ... 11, 16/17, 16/26 ... 27, 16/33
3SE2 4	8/35 ... 37	3TX4 2	3/139, 9/83, 12/33, 12/36, 12/50, 12/58	3VL9 000	16/45 ... 50, 16/58 ... 63, 16/70
3SE2 8	8/51	3TX4 4	3/136 ... 137, 3/140 ... 141	3VL9 1	16/45, 16/51 ... 52
3SE2 9	9/110	3TX4 7	3/140, 16/38 ... 39	3VL9 2	16/18, 16/46, 16/51 ... 53, 16/65
3SE3	8/40 ... 41, 8/43, 8/45, 8/49 ... 50, 9/110	3TX6	3/135, 17/65	3VL9 300	16/42, 16/45 ... 47, 16/52 ... 53, 16/58 ... 59, 16/66 ... 67
3SE6	8/62	3TX7 0	3/95 ... 100, 3/135	3VL9 32	16/18, 16/51, 16/58 ... 59, 16/65
3SE7	9/105 ... 107	3TX7 4	3/134, 3/139, 6/10, 7/15	3VL9 40	16/38, 16/40, 16/43, 16/47, 16/54, 16/60, 16/66
3SF2	9/108	3TX7 5	3/124, 3/134 ... 135, 7/14 ... 15	3VL9 42	16/18
3SF3	8/54 ... 59	3TX7 6	3/135, 7/14 ... 15	3VL9 43	16/18
3SF5	9/65, 9/96	3TY	3/135 ... 136, 3/142 ... 145	3VL9 44	16/18, 16/51, 16/65
3SF6	6/83	3UF1	7/14 ... 15	3VL9 5	16/18, 16/48, 16/55, 16/60 ... 61, 16/65
3SF7	6/83	3UF5	7/12 ... 14	3VL9 60	16/43, 16/48 ... 49, 16/54 ... 55, 16/61, 16/67
3SR	9/78	3UF7	7/7 ... 9, 16/70	3VL9 68	16/65
3SX1	5/49, 5/55, 6/13, 9/78, 9/83	3UG3	7/49 ... 54	3VL9 70	16/56, 16/59 ... 63
3SX3 0	8/39	3UG4	7/42 ... 43, 7/46, 7/48	3VL9 71	16/58 ... 63, 16/65
3SX3 10	8/38	3UL	7/16	3VL9 800	16/39, 16/44, 16/49 ... 50, 16/56 ... 57, 16/62 ... 63, 16/68 ... 69
3SX3 11	8/39	3VF	14/76, 16/71 ... 72	3VL9 81	16/40, 16/65
3SX3 12	8/38 ... 39	3VL17 0	16/6 ... 7, 16/20 ... 23	3WL11 06	15/5 ... 6, 15/8 ... 9, 15/11 ... 12, 15/14 ... 15
3SX3 13	8/39	3VL17 10	16/6 ... 7, 16/10 ... 11, 16/20 ... 23, 16/26 ... 27	3WL11 08	15/5 ... 6, 15/8 ... 9, 15/11 ... 12, 15/14 ... 15
3SX3 16	8/19	3VL17 12	16/6 ... 7, 16/20 ... 23	3WL11 10	15/5 ... 6, 15/8 ... 9, 15/11 ... 12, 15/14 ... 15
3SX3 17	8/12	3VL17 16	16/6 ... 7, 16/10 ... 11, 16/20 ... 23, 16/26 ... 27	3WL11 12	15/5 ... 6, 15/8 ... 9, 15/11 ... 12, 15/14 ... 15
3SX3 18	8/12	3VL17 2	16/6 ... 7, 16/20 ... 23	3WL11 16	15/5 ... 6, 15/8 ... 9, 15/11 ... 12, 15/14 ... 15
3SX3 19	8/45, 8/47, 8/51, 8/56 ... 57, 8/59	3VL17 9	16/6 ... 7, 16/20 ... 23	3WL12 08	15/6 ... 7, 15/9 ... 10, 15/12 ... 13, 15/15 ... 16
3SX3 20	8/47, 8/51, 8/57, 8/59	3VL27 05	16/6 ... 7, 16/20 ... 21, 16/24 ... 25	3WL12 10	15/6 ... 7, 15/9 ... 10, 15/12 ... 13, 15/15 ... 16, 15/42 ... 43
3SX3 21	8/19 ... 20, 8/39, 8/46, 8/56	3VL27 06	16/6 ... 11, 16/20 ... 21, 16/24 ... 27	3WL12 12	15/6 ... 7, 15/9 ... 10, 15/12 ... 13, 15/15 ... 16
3SX3 22	8/45 ... 46, 8/56, 8/60	3VL27 08	16/6 ... 7, 16/20 ... 21, 16/24 ... 25	3WL12 16	15/6 ... 7, 15/9 ... 10, 15/12 ... 13, 15/15 ... 16
3SX3 23	8/39, 8/46, 8/56, 9/106	3VL27 10	16/6 ... 11, 16/20 ... 21, 16/24 ... 27	3WL12 20	15/5 ... 16, 15/42 ... 43
3SX3 25	8/45 ... 46, 8/49 ... 50, 8/56, 8/58 ... 59	3VL27 12	16/6 ... 7, 16/20 ... 21, 16/24 ... 25	3WL12 25	15/5 ... 16
3SX3 26	8/12, 8/19 ... 20, 8/38 ... 39, 8/62	3VL27 16	16/6 ... 11, 16/17, 16/20 ... 21, 16/24 ... 27, 16/33	3WL12 32	15/6 ... 7, 15/9 ... 10, 15/12 ... 13, 15/15 ... 16
3SX3 27	8/12, 8/20, 8/38 ... 39	3VL37 20	16/6 ... 9, 16/20 ... 21, 16/24 ... 27	3WL12 4	15/42 ... 43
3SX3 28	8/19 ... 20, 8/38 ... 39	3VL37 25	16/6 ... 11, 16/17, 16/20 ... 21, 16/24 ... 27, 16/33	3WL13	15/7, 15/10, 15/13, 15/16
3SX3 30	8/12, 8/20, 8/39, 8/47, 8/51, 8/57, 8/59	3VL47 20	16/6 ... 7, 16/10 ... 11, 16/20 ... 21, 16/24 ... 25		
3SX3 31	8/12, 8/19, 8/38	3VL47 25	16/6 ... 7, 16/10 ... 11, 16/20 ... 21, 16/24 ... 25		
3SX9	8/42	3VL47 31	16/6 ... 11, 16/20 ... 21, 16/24 ... 27		
3SY	8/39, 8/41 ... 42, 9/79				
3TB	3/34, 3/73				
3TC	3/74, 3/76 ... 77				
3TD	3/54				

Appendix

Order number index

Order No.	Page	Order No.	Page	Order No.	Page
3WL5	15/38 ... 39	4BU47 43	10/74 ... 83	5SJ	19/55, 19/59 ... 60
3WL9 111	15/26 ... 36, 15/41, 16/38 ... 39	4BU47 52	10/64 ... 73	5SM1	19/94, 19/105
3WL9 2	15/24 ... 25, 15/40, 15/44	4BU47 53	10/74 ... 83	5SM2	19/72 ... 73, 19/103 ... 104
3WL9 3	15/26, 15/41	4BU52 32	10/64 ... 73	5SM3	19/85 ... 90, 19/95
3ZS1	7/9, 13/2 ... 4, 16/70	4BU52 33	10/74 ... 83	5SP	19/71, 19/82
3ZS2	15/32, 18/4, 18/6	4BU53 32	10/64 ... 73	5ST1	12/59, 19/82
4		4BU53 33	10/74 ... 83	5ST2	19/9, 19/11, 19/80, 19/107
4AM23 42	10/20 ... 23, 10/42 ... 46	4BU53 42	10/64 ... 73	5ST3 0	19/13, 19/54, 19/74 ... 76, 19/91, 19/98 ... 100
4AM26 42	10/20 ... 23, 10/42 ... 46	4BU53 43	10/74 ... 83	5ST3 6	19/78 ... 79, 19/93, 19/101
4AM32 42	10/6 ... 19, 10/24 ... 41	4BU54 32	10/64 ... 73	5ST3 7	19/9, 19/11, 19/13, 19/34, 19/41, 19/77 ... 78, 19/93, 19/101
4AM34 42	10/6 ... 19, 10/24 ... 41	4BU54 33	10/74 ... 83	5ST3 8	19/80, 19/92, 19/100 ... 101
4AM38 42	10/6 ... 19, 10/24 ... 41	4BU54 42	10/64 ... 73	5SU1	19/95, 19/97
4AM40 42	10/6 ... 19, 10/24 ... 41	4BU54 43	10/74 ... 83	5SW	19/91 ... 92, 19/107
4AM43 42	10/6 ... 19, 10/24 ... 41	4BU55 32	10/64 ... 69	5SY4	19/61 ... 64
4AM46 42	10/6 ... 19, 10/24 ... 41	4BU55 33	10/74 ... 79	5SY5	19/70
4AM48 42	10/6 ... 19, 10/24 ... 41	4BU56 32	10/64 ... 69	5SY6	19/53, 19/55 ... 58
4AM52 42	10/6 ... 19, 10/24 ... 41	4BU56 33	10/74 ... 79	5SY7	19/65 ... 67
4AM55 42	10/6 ... 19, 10/24 ... 41	4BU56 42	10/64 ... 69	5SY8	19/68 ... 69
4AM57 42	10/6 ... 19, 10/24 ... 41	4BU56 43	10/74 ... 79	5SZ9	19/105 ... 106
4AM61 42	10/24 ... 41	4BU58 32	10/64 ... 69	5TE	19/117
4AM64 42	10/24 ... 41	4BU58 33	10/74 ... 79	5TG8	19/80
4AM65 42	10/24 ... 41	4BU58 42	10/64 ... 69	6	
4AP	10/58 ... 60, 10/86 ... 87	4BU58 43	10/74 ... 79	6BK	7/24
4AT30 1	10/54	4BU58 52	10/64 ... 69	6ED1 050	7/19, 7/21, 7/23 ... 24
4AT30 32	10/24 ... 36, 10/39 ... 41	4BU58 53	10/74 ... 79	6ED1 052	7/18, 7/20
4AT36 0	10/54	4BU59 32	10/64 ... 69	6ED1 055	7/22
4AT36 12	10/24 ... 36, 10/39 ... 41, 10/54	4BU59 33	10/74 ... 79	6ED1 056	7/19, 7/21, 7/23
4AT36 32	10/24 ... 36, 10/39 ... 41	4BU60 32	10/64 ... 69	6ED1 057	6/70, 7/19, 7/21, 7/23, 7/26
4AT39 0	10/54	4BU60 33	10/74 ... 79	6ED1 058	7/19, 7/21, 7/23, 7/27
4AT39 12	10/24 ... 36, 10/39 ... 41, 10/54	4FK	10/56	6EP	2/42, 11/9 ... 14
4AT39 32	10/24 ... 36, 10/39 ... 41	4FL	10/55, 10/88	6ES5	6/78 ... 80
4AT4	10/54	4NC	14/118 ... 119	6ES7 13	6/79 ... 85
4AU	10/58 ... 59, 10/86 ... 87	5		6ES7 141	6/107, 6/114 ... 116
4AV	11/3 ... 8	5SA	19/15	6ES7 142	6/107, 6/114, 6/116
4AX	10/52 ... 53	5SB	19/15	6ES7 143	6/115, 6/117
4BU43 32	10/64 ... 73	5SC	19/15	6ES7 144	6/107, 6/118
4BU43 33	10/74 ... 83	5SD	19/16, 19/43, 19/109 ... 116	6ES7 145	6/107, 6/118
4BU43 42	10/64 ... 73	5SE	19/5, 19/43	6ES7 147	6/113
4BU43 43	10/74 ... 83	5SF	14/102, 19/17 ... 18, 19/48	6ES7 148	6/117, 6/119
4BU43 52	10/64 ... 73	5SG	14/102, 19/6 ... 7, 19/11 ... 12, 19/48, 19/50	6ES7 15	6/77 ... 80, 6/103, 6/106
4BU43 53	10/74 ... 83	5SH	14/92 ... 93, 14/102, 19/8 ... 10, 19/13 ... 14, 19/19 ... 21, 19/34, 19/41, 19/47, 19/49 ... 51	6ES7 193	6/73, 6/77 ... 87
4BU45 32	10/64 ... 73			6ES7 194	2/51, 6/57, 6/102 ... 108, 6/110, 6/112 ... 117, 6/119
4BU45 33	10/74 ... 83			6ES7 195	6/77
4BU45 42	10/64 ... 73			6ES7 198	6/110, 6/113 ... 119
4BU45 43	10/74 ... 83				
4BU47 32	10/64 ... 73				
4BU47 33	10/74 ... 83				
4BU47 42	10/64 ... 73				

Appendix

Order number index

Order No.	Page	Order No.	Page	Order No.	Page
6ES7 3	2/18, 6/83	8HA	14/73	8UC61 21	14/76, 14/109, 17/5, 17/11, 17/34, 17/36, 17/40 ... 41
6ES7 7	6/79 ... 80	8HC	14/72, 14/75 ... 76	8UC61 22	14/113, 16/72
6ES7 8	6/80, 6/82 ... 83	8HP1 1	14/60, 14/65	8UC61 6	14/107
6ES7 90	6/72, 6/113	8HP1 2	14/60, 14/65	8UC62 1	14/76, 14/107, 14/111, 14/114, 17/11, 17/36, 17/41
6ES7 95	6/78 ... 80, 6/106	8HP1 3	14/61	8UC62 20	14/114
6ES7 97	16/70	8HP1 4	14/73	8UC62 22	14/76, 14/109, 14/113, 17/5, 17/11, 17/34, 17/36, 17/40 ... 41
6ES7 98	6/83	8HP1 5	14/71 ... 72	8UC62 6	14/107, 14/111
6ES7 991	6/105	8HP1 7	14/66 ... 69	8UC62 7	14/113
6ES7 998	6/77 ... 78, 6/82, 6/105 ... 106, 6/108, 6/114, 6/116 ... 119	8HP1 8	14/72 ... 73, 14/75	8UC63 10	14/114
6ES714	6/108	8HP2	14/60 ... 65, 17/10	8UC63 13	14/76, 14/107, 17/11, 17/37, 17/42
6ES715	6/77	8HP5	14/65	8UC63 14	14/76, 14/107, 14/111, 17/9, 17/12
6FX	6/84	8HP6 1	14/75	8UC63 20	14/114
6GK1 2	2/46	8HP6 2	14/75	8UC63 23	14/76, 14/109, 17/5, 17/11, 17/34, 17/37, 17/40, 17/42
6GK1 4	2/20	8HP6 3	14/60, 14/72 ... 73	8UC63 24	14/76, 14/109, 14/113, 17/7, 17/9, 17/12
6GK1 90	6/77 ... 78, 6/103 ... 104, 6/106, 6/108, 6/113	8HP6 4	14/64, 17/56	8UC64 1	14/76, 14/107, 14/114, 17/9, 17/13, 17/38
6GK1 97	2/18, 2/20, 6/118	8HP6 5	14/73 ... 74	8UC64 20	14/114
6GK7	2/17 ... 18, 6/118	8HP6 6	14/68, 14/73 ... 74	8UC64 24	14/76, 14/109, 17/7, 17/9, 17/13, 17/34, 17/38
6GT	6/118	8HP9	14/76 ... 77, 14/79 ... 80	8UC65	14/107, 14/109, 14/111, 14/113 ... 114, 17/12 ... 13
6SL	6/71 ... 72	8JH	14/66, 14/68 ... 70, 14/73 ... 74, 19/19, 19/47	8UC92	14/114, 17/34, 17/38
6XV	6/78, 6/103 ... 104, 6/106, 6/108, 6/113	8JK	14/66 ... 70, 14/73, 19/47	8UC93	14/115, 17/7 ... 9, 17/12 ... 13
7		8MC	14/22 ... 23	8UC95	17/8 ... 9
7KT	19/120 ... 129	8ME	14/32	8UC96	17/8 ... 9
7PV	7/38	8MF	14/24 ... 29	8US10	5/21, 5/27, 6/44, 14/86 ... 87, 16/64
7PX	7/38	8MR	14/30 ... 34	8US11	5/21, 14/87, 14/98
8		8UB	17/8 ... 9	8US12 0	14/95
8GD	14/51, 14/53	8UC60 1	14/114	8US12 1	5/21, 14/98 ... 99, 16/64, 17/65
8GE	14/47	8UC60 2	14/114, 17/11, 17/36 ... 38, 17/41 ... 42	8US12 5	5/21, 5/27, 6/44, 14/97, 14/99
8GF	12/33, 12/36, 14/68	8UC60 31	14/114, 17/11, 17/36, 17/41	8US12 6	5/21, 6/44, 14/97 ... 99
8GK1	14/37 ... 39	8UC60 32	14/114, 17/11, 17/36, 17/42	8US12 9	14/99, 17/65
8GK4 3	14/40	8UC60 33	14/114, 17/11, 17/37, 17/42	8US19 0	14/84
8GK4 4	14/41 ... 43	8UC60 34	14/114, 17/12 ... 13, 17/38	8US19 21	14/53, 14/66, 14/85, 14/90, 14/95 ... 96, 14/103, 19/47
8GK4 5	14/44 ... 45	8UC60 35	14/114	8US19 22	14/68, 14/84 ... 85, 14/92 ... 94, 14/96, 19/51
8GK4 6	14/46	8UC60 81	14/114, 17/11, 17/36, 17/41	8US19 23	14/68, 14/92, 19/47
8GK4 7	14/47 ... 48	8UC60 82	14/114, 17/11, 17/36, 17/42	8US19 27	14/98, 16/64
8GK4 8	14/37 ... 39, 14/49	8UC60 83	14/114, 17/11, 17/37, 17/42	8US19 4	14/94 ... 96, 14/103, 19/47
8GK9 1	14/50, 14/53	8UC60 84	14/114, 17/12 ... 13, 17/38	8US19 98	5/27, 6/44 ... 45, 14/86 ... 87, 14/90, 14/97 ... 99, 14/103
8GK9 3	14/53	8UC61 10	14/114	8WA1 010	12/34
8GK9 5	14/50 ... 51, 14/53	8UC61 11	14/76, 14/107, 17/11, 17/36, 17/41	8WA1 011	12/30 ... 34, 12/36, 12/38 ... 42, 12/45, 12/47
8GK9 6	14/54 ... 55	8UC61 12	14/111, 16/72	8WA1 012	12/37
8GK9 7	14/52	8UC61 20	14/114	8WA1 2	12/30 ... 32, 12/43
8GK9 9	14/50 ... 53, 14/56 ... 57			8WA1 3	12/31

Appendix

Order number index

Order No.	Page	Order No.	Page	Order No.	Page
8WA1 5	12/40	8WA2 860	14/69	E	
8WA1 6	12/33			E20	15/32
8WA1 7	12/30, 12/48	8WA2 861	14/69		
8WA1 80	12/31, 12/36, 12/58 ... 59	8WA2 862	12/27	L	
8WA1 81	12/30 ... 32, 12/36, 12/38, 12/43, 12/60	8WA2 863	12/27	LZX	3/102 ... 105, 7/38
		8WA2 864	12/27		
8WA1 820	12/30, 12/40	8WA2 865	12/27	Z	
8WA1 821	12/31, 12/43			Z23	2/47
8WA1 822	12/19 ... 20, 12/30 ... 33, 12/36 ... 38, 12/40 ... 43, 12/45, 12/47, 12/59	8WA2 866	12/27		
8WA1 823	12/31, 12/38	8WA2 867	12/17, 12/25, 12/33, 12/36		
8WA1 824	12/32	8WA2 868	6/81, 6/83, 6/87, 12/17, 12/25, 12/33, 12/36		
		8WA2 87	12/17, 12/25, 12/33, 12/36		
8WA1 825	12/30 ... 31, 12/36, 12/38, 12/45	8WA2 88	4/9, 4/16, 12/25		
8WA1 828	12/31				
8WA1 83	12/38	8WA3	12/7 ... 8		
8WA1 84	12/31	8WA4	12/49		
8WA1 85	12/30 ... 31, 12/36, 12/38, 12/60, 14/74	8WA7	12/31, 12/38, 12/45, 12/59 ... 60		
		8WA8 0	12/34		
8WA1 860	12/30	8WA8 5	12/7, 12/10 ... 11		
8WA1 862	12/31, 12/36, 12/38, 12/43				
8WA1 864	12/60, 14/74	8WA8 80	12/57		
8WA1 865	12/30 ... 31, 12/38	8WA8 82	12/58		
8WA1 867	12/40	8WA8 846	12/58		
		8WA8 847	12/48, 12/53 ... 57		
8WA1 868	12/40, 12/59	8WA8 848	6/83, 6/87, 12/36, 12/48, 12/53 ... 57		
8WA1 87	12/40, 12/59				
8WA1 88	12/31, 12/38, 12/45, 12/58 ... 59	8WA8 85	12/50		
8WA1 89	12/19, 12/30 ... 31, 12/38, 12/42	8WA8 86	6/83, 6/87, 12/51 ... 52		
8WA1 9	12/48	8WA9	12/48		
8WA2 011	12/14 ... 23, 12/25, 12/27	8WC	12/33, 12/36, 14/69, 14/84, 14/93		
8WA2 5	12/9, 12/11				
8WA2 803	3/125, 5/27, 5/56, 12/25, 12/27	8WD	9/112 ... 117		
8WA2 804	3/125, 5/27, 5/56				
8WA2 805	12/17, 12/25				
8WA2 806	6/49, 12/25				
8WA2 807	2/34, 5/56				
8WA2 808	12/25				
8WA2 81	12/14 ... 16, 12/23, 12/25				
8WA2 82	12/23, 12/25, 12/27				
8WA2 830	12/14 ... 16, 12/20 ... 22, 12/24				
8WA2 831	12/14 ... 16, 12/20 ... 22, 12/24				
8WA2 832	12/14 ... 16, 12/20 ... 22, 12/24				
8WA2 835	12/14 ... 16, 12/25				
8WA2 836	12/14 ... 16, 12/25				
8WA2 837	12/17, 12/25				
8WA2 838	12/25, 12/58				
8WA2 842	6/81, 6/83, 6/87, 12/17, 12/25, 12/49				
8WA2 843	12/17, 12/23, 12/25				
8WA2 844	12/14, 12/25				
8WA2 845	12/14, 12/25				
8WA2 847	12/27				
8WA2 848	12/17, 12/23, 12/25				
8WA2 85	12/14, 12/16, 12/18, 12/24 ... 25, 12/58				

Appendix

Fax order - simply copy, fill out and fax

To:

(For address see "Siemens contacts")

Fax No.

Contact

Pos.	Order No.	Product name	Quantity	Indiv. price	Total price
1	E 8 6 0 6 0 - T 1 0 0 2 - A 1 0 1 - A 5 - 7 6 0 0	Technical Information LV 1 T · 2006		13,00 €	

Subject to the General Conditions of Supply and Delivery listed in the catalog/price list of your sales representative.

Company address (stamp):

Customer number (if available)

Company/Department

Street, No.

ZIP code/City

Contact

Tel.No./Fax

Customer Order No.:

Date

Delivery address (if different from company address):

Company/Department

Street, No.

ZIP code/City

Notes

Requested delivery date:

Signature

Terms and conditions of sale and delivery Export regulations

Terms and conditions of sale and delivery

By using this catalog you can acquire hardware and software products described therein from the Siemens AG subject to the following terms. Please note! The scope, the quality and the conditions for supplies and services, including software products, by any Siemens entity having a registered office outside of Germany, shall be subject exclusively to the General Terms and Conditions of the respective Siemens entity.

For customers with a seat or registered office in the Federal Republic of Germany

The "General Terms of Payment" as well as the "General Conditions for the Supply of Products and Services of the Electrical and Electronics Industry" shall apply.

For software products, the "General License Conditions for Software Products for Automation and Drives for Customers with a Seat or registered Office in Germany" shall apply.

For customers with a seat or registered office outside of Germany

The "General Terms of Payment" as well as the "General Conditions for Supplies of Siemens, Automation and Drives for Customers with a Seat or registered Office outside of Germany" shall apply.

For software products, the "General License Conditions for Software Products for Automation and Drives for Customers with a Seat or registered Office outside of Germany" shall apply.

General

The prices are in € (Euro) ex works, exclusive packaging.

The sales tax (value added tax) is not included in the prices. It shall be debited separately at the respective rate according to the applicable legal regulations.

In addition to the prices of products which include silver, plump, aluminum and/or copper, surcharges may be calculated if the respective limits of the notes are exceeded. The respective note (e.g. source: German newspaper "Handesblatt" in category "deutsche Edelmetalle" and "Metallverarbeiter") for silver ("verarbeitetes Silber"), plump ("Blei in Kabeln"), aluminum ("Aluminium in Kabeln") and copper ("Elektrolytkupfer", "DEL-Notiz") respectively, of the day the order or rather the on call order is received, is decisive for the calculation of the surcharges.

Surcharges of copper shall be calculated for Drives at a note ("DEL-Notiz") above EUR 225,00 / 100 Kg and for chokes / transformers above EUR 150,00 / 100 kg.

Surcharges shall be charged based on the quantities of the materials which are contained in the relevant products.

Prices are subject to change without prior notice. We will debit the prices valid at the time of delivery.

The dimensions are in mm. Illustrations are not binding.

Insofar as there are no remarks on the corresponding pages, - especially with regard to data, dimensions and weights given - these are subject to change without prior notice.

Comprehensive Terms and Conditions of Sale and Delivery are available free of charge from your local Siemens business office under the following Order Nos.:

- 6ZB5310-0KR30-0BA0
(for customers based in the Federal Republic of Germany)
- 6ZB5310-0KS53-0BA0
(for customers based outside of the Federal Republic of Germany)

or download them from the Internet
<http://www.siemens.com/automation/mall>
(Germany: A&D Mall Online-Help System)

Export regulations

The products listed in this catalog / price list may be subject to European / German and/or US export regulations.

Therefore, any export requiring a license is subject to approval by the competent authorities.

According to current provisions, the following export regulations must be observed with respect to the products featured in this catalog / price list:

AL	Number of the <u>German Export List</u> . Products marked other than "N" require an export license. In the case of software products, the export designations of the relevant data medium must also be generally adhered to. Goods labeled with an " <u>AL not equal to N</u> " are subject to a European or German export authorization when being exported out of the EU.
ECCN	<u>Export Control Classification Number</u> . Products marked other than "N" are subject to a reexport license to specific countries. In the case of software products, the export designations of the relevant data medium must also be generally adhered to. Goods labeled with an " <u>ECCN not equal to N</u> " are subject to a US re-export authorization.

Even without a label or with an "AL: N" or "ECCN: N", authorization may be required due to the final destination and purpose for which the goods are to be used.

The deciding factors are the AL or ECCN export authorization indicated on order confirmations, delivery notes and invoices.

Errors excepted and subject to change without prior notice.

A&D/VuL/De 17.03.05

Appendix

Notes

Appendix

Notes

Appendix

Notes

Appendix

Notes

Appendix

Notes

Overview

The CD-ROM supplied contains the following:

- Catalog LV 1 · 2006 and
- Technical Information LV 1 T · 2006

for Low-Voltage Controls and Distribution
with SIRIUS - SENTRON - SIVACON
in electronic form, as structured
PDF files:



Appendix

Notes

Siemens AG
Automation and Drives
[Low-Voltage Controls and Distribution](#)
Postfach 48 48
90327 NÜRNBERG
GERMANY

Order-No.
E86060-K1002-A101-A5-7600
KG 0306 20.0 E/O 1360 En/ 603010
Printed in Germany

Catalogs of the Automation and Drives Group (A&D)

Further information can be obtained from our branch offices listed in the appendix or at www.siemens.com/automation/partner

Automation and Drives	<i>Catalog</i>	
Interactive catalog on CD-ROM and on DVD		
• The Offline Mall of Automation and Drives	CA 01	
Automation Systems for Machine Tools		
SINUMERIK & SIMODRIVE	NC 60	
SINUMERIK & SINAMICS	NC 61	
Drive Systems		
<u>Variable-Speed Drives</u>		
SINAMICS G130 Drive Converter Chassis Units, SINAMICS G150 Drive Converter Cabinet Units	D 11	
SINAMICS G110 Inverter Chassis Units	D 11.1	
SINAMICS GM150/SINAMICS SM150	D 12	
Medium-Voltage Converter 0.6 MVA to 28 MVA		
SINAMICS S120 Vector Control Drive System	D 21.1	
SINAMICS S120 Servo Control Drive System	D 21.2	
SINAMICS S150 Drive Converter Cabinet Units	D 21.3	
Asynchronous Motors Standardline	D 86.1	
DC Motors	DA 12	
SIMOREG DC MASTER 6RA70 Digital Chassis Converters	DA 21.1	
SIMOREG K 6RA22 Analog Chassis Converters	DA 21.2	
SIMOREG DC MASTER 6RM70 Digital Converter Cabinet Units	DA 22	
SIMOVERT PM Modular Converter Systems	DA 45	
SIEMOSYN Motors	DA 48	
MICROMASTER 410/420/430/440 Inverters	DA 51.2	
MICROMASTER 411/COMBIMASTER 411	DA 51.3	
SIMOVERT MASTERDRIVES Vector Control	DA 65.10	
SIMOVERT MASTERDRIVES Motion Control	DA 65.11	
Synchronous and asynchronous servomotors for SIMOVERT MASTERDRIVES	DA 65.3	
SIMODRIVE 611 universal and POSMO	DA 65.4	
<u>Low-Voltage Three-Phase-Motors</u>		
Squirrel-Cage Motors, Totally Enclosed, Fan-Cooled	M 11	
<u>Automation Systems for Machine Tools SIMODRIVE</u>	NC 60	
• Main Spindle/Feed Motors		
• Converter Systems SIMODRIVE 611/POSMO		
<u>Automation Systems for Machine Tools SINAMICS</u>	NC 61	
• Main Spindle/Feed Motors		
• Drive System SINAMICS S120		
<u>Drive and Control Components for Hoisting Equipment</u>	HE 1	
Electrical Installation Technology		
ALPHA Small Distribution Boards and Distribution Boards	ET A1	
<i>PDF: ALPHA 8HP Molded-Plastic Distribution System</i>	ET A3	
<i>PDF: ALPHA FIX Terminal Blocks</i>	ET A5	
BETA Modular Installation Devices	ET B1	
DELTA Switches and Outlets	ET D1	
GAMMA Building Management Systems	ET G1	
Human Machine Interface Systems SIMATIC HMI	ST 80	
Industrial Communication for Automation and Drives	<i>Catalog</i>	IK PI
Low-Voltage		
Controls and Distribution – SIRIUS, SENTRON, SIVACON		LV 1
Controls and Distribution – Technical Information SIRIUS, SENTRON, SIVACON		LV 1 T
Circuit-Breakers from 10 A to 3200 A		LV 35
SIDAC reactors and filters		LV 60
SIVACON 8PS Busbar trunking systems CD, BD01, BD2 up to 1250 A		LV 70
Motion Control System SIMOTION		PM 10
Process Instrumentation and Analytics		
Field Instruments for Process Automation		FI 01
Measuring Instruments for Pressure, Differential Pressure, Flow, Level and Temperature, Positioners and Liquid Meters		
<i>PDF: Indicators for panel mounting</i>		MP 12
SIREC Recorders and Accessories		MP 20
SIPART, Controllers and Software		MP 31
SIWAREX Weighing Systems		WT 01
Continuous Weighing and Process Protection		WT 02
Process Analytical Instruments		PA 01
<i>PDF: Process Analytics, Components for the System Integration</i>		PA 11
SIMATIC Industrial Automation Systems		
SIMATIC PCS Process Control System		ST 45
Products for Totally Integrated Automation and Micro Automation		ST 70
SIMATIC PCS 7 Process Control System		ST PCS 7
Add-ons for the SIMATIC PCS 7 Process Control System		ST PCS 7.1
Migration solutions with the SIMATIC PCS 7 Process Control System		ST PCS 7.2
pc-based Automation		ST PC
SIMATIC Control Systems		ST DA
SIMATIC Sensors		FS 10
SIPOS Electric Actuators		
Electric Rotary, Linear and Part-turn Actuators		MP 35
Electric Rotary Actuators for Nuclear Plants		MP 35.1/2
Systems Engineering		
Power supplies SITOP power		KT 10.1
System cabling SIMATIC TOP connect		KT 10.2
System Solutions		
Applications and Products for Industry are part of the interactive catalog CA 01		
TELEPERM M Process Control System		
<i>PDF: AS 488/TM automation systems</i>		PLT 112

PDF: These catalogs are only available as pdf files.

A&D/3U/En 06.02.06



The information provided in this catalog contains descriptions or characteristics of performance which in case of actual use do not always apply as described or which may change as a result of further development of the products. An obligation to provide the respective characteristics shall only exist if expressly agreed in the terms of contract. Availability and technical specifications are subject to change without notice.

Token fee 10.00 €

Siemens AG

Automation and Drives
Low-Voltage Controls and Distribution
Postfach 4848
90327 NÜRNBERG
GERMANY

www.siemens.com/lowvoltage

Order No. E86060-K1002-A101-A5-7600

SIEMENS

SIRIUS • SENTRON • SIVACON

Catalog **LV 1 • 2006**