

# SIEMENS

## SIRIUS

### 3RW44 Soft starter

#### System manual

Table of contents  
Important notes

---

Introduction **1**

---

Configuration instructions **2**

---

Installation, connection and  
branch construction **3**

---

Display, controls and device  
interfaces **4**

---

Commissioning **5**

---

Device functions **6**

---

Diagnostics and messages **7**

---

Circuit examples **8**

---

General technical data **9**

---

#### **Appendix**

---

Index

---

**Order No.: 3ZX1012-0RW44-1AC1**

**Issue 06/2005**

GWA 4NEB 535 2195-02 DS 01



## Safety instructions

This document contains instructions you are strongly advised to observe in order to guarantee your personal safety and to avoid damage to property. The instructions on your personal safety are marked by a warning triangle, notes on risk of property damage have no warning triangle. Depending on the degree of risk, the instructions are presented as follows.



### Danger

means that death or serious physical injuries **will** follow if you do not take the appropriate precautionary measures.



### Warning

means that death or serious physical injuries **may** follow if you do not take the appropriate precautionary measures.



### Caution

with a warning triangle means that minor physical injuries may follow if you do not take the appropriate precautionary measures.

### Caution

without a warning triangle means that damage to property may follow if you do not take the appropriate precautionary measures.

### Notice

means that an undesired result or condition may occur if the corresponding instruction is not observed.

Where several degrees of risk are present at the same time, the instruction for the highest degree of risk is used. If an instruction with a warning triangle contains a warning against personal injury, the same instruction may also contain an additional warning against damage to property.

## Qualified personnel

The associated device/system must only be configured and used in conjunction with this documentation. Devices/systems must be commissioned and operated by **qualified personnel** only. Qualified personnel according to the safety instructions of this documentation are persons authorized to commission, ground, and mark devices, systems and current circuits according to the relevant safety standards.

## Notes on proper use

Please observe the following:



### Warning

The device may only be used for applications specified in the catalog and the technical descriptions. Furthermore it may only be used in combination with third-party devices and components recommended or approved by Siemens. Faultless and safe operation is only ensured if the product is transported, stored, mounted and installed properly and if operation and maintenance is carried out conscientiously.

## Trademarks

All names carrying the industrial property mark ® are registered trademarks of Siemens AG. The other designations in this publication may be trademarks whose use by third parties for their own purposes may infringe the rights of the owners.

### Copyright Siemens AG 2004. All rights reserved.

This document shall not be transmitted or reproduced, nor shall its contents be exploited or disclosed to third persons without prior written consent from Siemens. Infringements will be subject to damage claims. All rights reserved, in particular in case of a patent grant of utility model registration.

### Disclaimer of liability

Although we have carefully checked the contents of this publication for conformity with the hardware and software described, we cannot guarantee complete conformity since errors cannot be excluded. The information provided in this manual is checked at regular intervals and any corrections which might become necessary will be included in the next editions.

Siemens AG  
Automation & Drives  
P.O. box 4848, 90327 Nuremberg, Germany

© Siemens AG 2004  
Subject to technical changes

Siemens Aktiengesellschaft



	<b>Important notes</b> .....	<b>v</b>
<b>1</b>	<b>Introduction</b> .....	<b>1-1</b>
1.1	Physical basics of the 3-phase asynchronous motor and mode of operation of the soft starter ...	1-2
1.1.1	3-phase asynchronous motor .....	1-2
1.1.2	Operating mode of the SIRIUS 3RW44 electronic soft starter .....	1-4
1.2	Application and use .....	1-7
1.3	Boundary conditions for storage and operation .....	1-8
<b>2</b>	<b>Configuration instructions</b> .....	<b>2-1</b>
2.1	Configuration .....	2-2
2.1.1	Serial PC interface RS 232 and Softstarter ES parameterizing and operating software .....	2-2
2.1.2	Win-SOFTSTARTER selection and simulation program .....	2-2
2.1.3	Training course for SIRIUS soft starters (SD-SIRIUSO) .....	2-2
2.2	Normal or heavy starting .....	2-3
2.2.1	Example applications for normal starting (Class 10) .....	2-3
2.2.2	Example applications for heavy starting (Class 20) .....	2-3
2.2.3	Example applications for heaviest starting (Class 30) .....	2-4
2.3	On-time and switching frequency .....	2-5
2.4	Installation height and ambient temperature .....	2-6
2.5	Factory setting .....	2-7
<b>3</b>	<b>Installation, connection and branch layout</b> .....	<b>3-1</b>
3.1	Installing the soft starter .....	3-2
3.1.1	Unpacking .....	3-2
3.1.2	Mounting position .....	3-2
3.1.3	Standards .....	3-2
3.1.4	Mounting dimensions and clearances .....	3-3
3.2	Branch layout .....	3-4
3.2.1	General .....	3-4
3.2.2	Soft starters in standard circuits .....	3-5
3.2.3	Soft starter in inside delta circuits .....	3-6
3.2.4	Soft starter with contactor disconnecter (main contactor) .....	3-8
3.3	Protection of the soft starter against short circuits .....	3-9
3.4	Capacitors for power factor improvement .....	3-10
3.5	Electrical connection .....	3-10
3.5.1	Control and auxiliary current connection .....	3-10
3.5.2	Main current connection .....	3-11
3.5.3	Conductor cross-sections .....	3-12
<b>4</b>	<b>Display, controls and device interfaces</b> .....	<b>4-1</b>
4.1	Display and controls .....	4-2
4.2	Device interfaces .....	4-3
4.2.1	Local device interface .....	4-3
4.2.2	Profibus interface (optional) .....	4-3
<b>5</b>	<b>Commissioning</b> .....	<b>5-1</b>
5.1	Menu structure, navigation, changing parameters .....	5-2
5.1.1	Menu structure and navigation .....	5-2
5.1.2	Changing parameters: for example motor data .....	5-3

5.2	Switching on for the first time	5-4
5.2.1	Quick start menu	5-4
5.3	User-specific commissioning	5-6
5.3.1	“Settings” main menu item	5-7
5.4	Making settings in the selected parameter set	5-8
5.4.1	Select parameter set	5-8
5.4.2	Entering motor data	5-9
5.4.3	Determining the starting mode	5-10
5.4.4	Determining the stopping mode	5-16
5.4.5	Setting slow speed parameters	5-19
5.4.6	Determining current limits	5-19
5.4.7	Parameterization of the inputs	5-20
5.4.8	Parameterization of the outputs	5-20
5.4.9	Selection of motor protection settings	5-22
5.4.10	Selection of display settings	5-23
5.4.11	Determining the protective functions	5-24
5.4.12	Determining the names on the device display	5-24
5.4.13	Saving options	5-25
5.5	Other device functions	5-28
5.5.1	Measured value display	5-28
5.5.2	Status display	5-29
5.5.3	Motor control (assign control priority)	5-30
5.5.4	Safety (define user level, parameterization protection)	5-30
<b>6</b>	<b>Device functions</b>	<b>6-1</b>
6.1	Various parameter sets	6-2
6.2	Starting modes	6-3
6.2.1	Voltage ramp	6-3
6.2.2	Torque control	6-5
6.2.3	Breakaway pulse in combination with voltage ramp or torque control starting mode	6-7
6.2.4	Current limiting in combination with voltage ramp or torque control starting mode	6-9
6.2.5	Starting mode: direct on-line	6-10
6.2.6	Starting mode: motor heating	6-10
6.3	Stopping modes	6-11
6.3.1	Coasting down	6-11
6.3.2	Torque control and pump stop	6-12
6.3.3	DC braking / combined braking	6-13
6.4	Slow speed function	6-16
6.5	Current limit values	6-17
6.6	Motor protection functions	6-18
6.7	Inherent protection	6-22
<b>7</b>	<b>Diagnostics and messages</b>	<b>7-1</b>
7.1	Diagnostics, messages	7-2
7.1.1	Status messages	7-2
7.1.2	Warnings and group errors	7-2
7.1.3	Device errors	7-4
<b>8</b>	<b>Circuit examples</b>	<b>8-1</b>
8.1	Connection examples for main and control circuits	8-2
8.1.1	3RW44 in a standard circuit with control via keys	8-2
8.1.2	3RW44 in a standard circuit with line contactor and control via PLC	8-3

8.1.3	3RW44 in a standard circuit with DC braking <sup>3)</sup> stopping function for device types 3RW44 22 to 3RW44 25 .....	8-4
8.1.4	3RW44 in a standard circuit with DC braking <sup>3)</sup> stopping function for device types 3RW44 26 to 3RW44 47 .....	8-5
8.1.5	3RW44 in an inside delta circuit .....	8-6
8.1.6	3RW44 in a standard circuit and controlled like a contactor .....	8-7
8.1.7	3RW44 in a standard circuit with soft start/stop and additional slow speed function in both directions of rotation with one parameter set .....	8-8
8.1.8	3RW 44 in a standard circuit with reversing operation via main contactors with one parameter set	8-9
<b>9</b>	<b>General technical data .....</b>	<b>9-1</b>
9.1	Menu structure .....	9-2
9.2	Transport and storage conditions .....	9-4
9.3	Technical data .....	9-5
9.3.1	Selection and ordering data .....	9-5
9.3.2	Technical data power component .....	9-7
9.3.3	Technical data control section .....	9-10
9.3.4	Conductor cross-sections .....	9-13
9.3.5	Electromagnetic compatibility .....	9-14
9.3.6	Branch component layout (standard circuit) .....	9-15
9.3.7	Branch component layout (inside delta circuit) .....	9-16
9.3.8	Accessories .....	9-17
9.4	Tripping characteristics .....	9-18
9.4.1	Motor protection tripping characteristics: 3RW44 with symmetry .....	9-18
9.4.2	Motor protection tripping characteristics: 3RW44 with asymmetry .....	9-18
9.5	Dimension drawings .....	9-19
	<b>Index .....</b>	<b>Index-1</b>





## Important notes

### **Objective of this manual**

This manual contains basics and tips on the application of SIRIUS 3RW44 soft starters. The SIRIUS 3RW44 soft starter is an electronic motor control device for optimized starting and stopping of 3-phase asynchronous motors. The manual describes all the SIRIUS 3RW44 soft starter functions.

### **Target group**

The manual is aimed at all users who deal with

- commissioning
- service and maintenance
- planning and configuration of plants

### **Required basic knowledge**

General knowledge in the field of general electrical engineering is required for understanding this manual.

### **Validity**

This manual is valid for SIRIUS 3RW44 soft starters. It contains a description of the components that are valid at the time of publication of this manual. We reserve the right to include an updated product information leaflet with new components and new component versions.

### **Definitions**

If the short form 3RW44 is used in the text, it refers to the SIRIUS 3RW44 soft starter.

### **Standards and approvals**

The SIRIUS 3RW44 soft starter complies to the IEC/EN 60947-4-2 standard.

### Disclaimer of liability

The manufacturer of the system or machine is responsible for ensuring the correct overall functioning. SIEMENS AG, its branch offices and associated companies (hereinafter referred to as "Siemens") cannot guarantee all properties of a system or machine not designed by SIEMENS.

SIEMENS can also not assume liability for recommendations given or implied by the following description. No new guarantee/warranty or liability claims in excess of the general terms and conditions of SIEMENS can be deduced from the following description.

### Handling

To facilitate and speed up access to special information, the manual contains the following aids:

- A table of contents can be found at the beginning of the manual.
- The individual chapters contain subheadings to provide an overview of the contents of the section.
- At the end of the manual there is an extensive index to enable you to quickly access the required information.

### Always up-to-date information

For questions on motor starters, your regional contact persons for communication-capable low-voltage switchgear will be pleased to assist you. You will find a list of contact persons and the latest version of the manual on the Internet at:

**<http://www.siemens.de/sanftstarter>**

Please address technical questions to:

<b>Technical Assistance:</b> Telephone: +49 (0) 911-895-5900 (8 <sup>00</sup> - 17 <sup>00</sup> CET) Fax: +49 (0) 911-895-5907 E-mail: <a href="mailto:technical-assistance@siemens.com">technical-assistance@siemens.com</a> Internet: <a href="http://www.siemens.de/lowvoltage/technical-assistance">www.siemens.de/lowvoltage/technical-assistance</a>
<b>Technical support:</b> Telephone: +49 (0) 180 50 50 222

### Corrections sheet

A corrections sheet is included at the end of the manual. Please enter your suggestions for improvement, supplements and corrections and send the sheet back to us. This will help us to improve the following issue.

# Introduction

# 1

<b>Chapter</b>	<b>Subject</b>	<b>Page</b>
1.1	Physical basics of the 3-phase asynchronous motor and mode of operation of the soft starter	1-2
1.1.1	3-phase asynchronous motor	1-2
1.1.2	Operating mode of the SIRIUS 3RW44 electronic soft starter	1-4
1.2	Application and use	1-7
1.3	Boundary conditions for storage and operation	1-8

## 1.1 Physical basics of the 3-phase asynchronous motor and mode of operation of the soft starter

### 1.1.1 3-phase asynchronous motor

#### Applications of the 3-phase asynchronous motor

Thanks to their robust and simple design and low-maintenance operation, 3-phase asynchronous motors are used in large numbers in commercial applications, trade and industry.

#### Problem

If switched on directly, the typical current and torque behavior of the 3-phase asynchronous motor may negatively influence the feeding supply network and the load machine during start-up.

#### Starting current

3-phase asynchronous motors have a high direct starting current  $I_{(starting)}$ . Depending on the motor version, this current may be 3 times to 15 times the size of the rated operating current. A typical value is the 7 to 8 times the size of the motor rated current.

#### Disadvantage

This results in the following disadvantage

- Higher load on the electrical supply network. This means that the supply network must be dimensioned to this higher output during motor start-up.

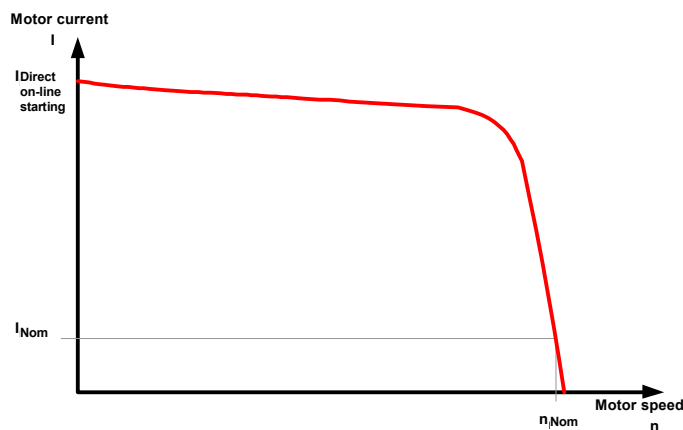

Fig. 1-1: Typical starting current behavior of a 3-phase asynchronous motor

#### Start torque

The start torque and the stalling torque can usually be assumed to be between the 2 times and 4 times the rated torque. For the load machine, this means that the starting and acceleration forces in relation to rated operation result in increased mechanical load on the machine and the conveyed material.

#### Disadvantages

This results in the following disadvantages

- Higher load on mechanical parts of the machine
- Higher costs because of application wear and maintenance

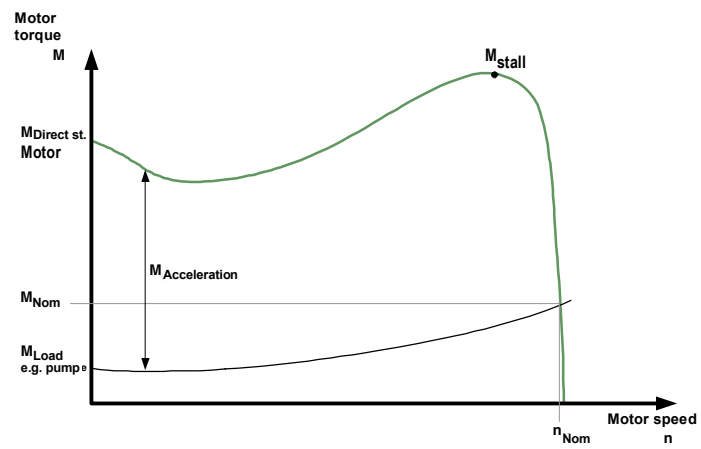

Fig. 1-2: Typical start torque behavior of a 3-phase asynchronous motor

### Solution

The current and torque behavior during start-up can be optimally adapted to the requirement of the application using the SIRIUS 3RW44 electronic soft starter.

### 1.1.2 Operating mode of the SIRIUS 3RW44 electronic soft starter

The 3RW44 soft starter has two antiparallel thyristors in each of the phases. There is one thyristor for the positive and one thyristor for the negative half wave.

Using phase angle control and various control methods, the r.m.s. value of the motor voltage is increased from a definable start voltage or start torque to the motor rated voltage within a selectable starting time.

The motor current acts proportional to the voltage applied to the motor. Thus the starting current is reduced by the factor of the voltage that is applied to the motor.

The torque behaves quadratically in relation to the voltage applied to the motor. The start torque is thus reduced quadratically based on the voltage applied to the motor.

#### Example

SIEMENS motor 1LG4253AA (55 kW)

Rated data at 400 V:

$P_e$ :	55 kW
$I_e$ :	100 A
$I_{\text{direct on-line start}}$ :	approx. 700 A
$M_e$ :	355 Nm
$M_{\text{direct on-line start}}$ :	approx. 700 Nm
Set start voltage:	50 % (1/2 supply voltage)

=>  $I_{\text{start}}$  1/2 of the direct-start switch-on current (approx. 350 A)

=>  $M_{\text{start}}$  1/4 of the direct on-line start torque (approx. 175 Nm)

The following graphs illustrate the behavior of the starting current and torque of a 3-phase asynchronous motor in combination with a soft starter:

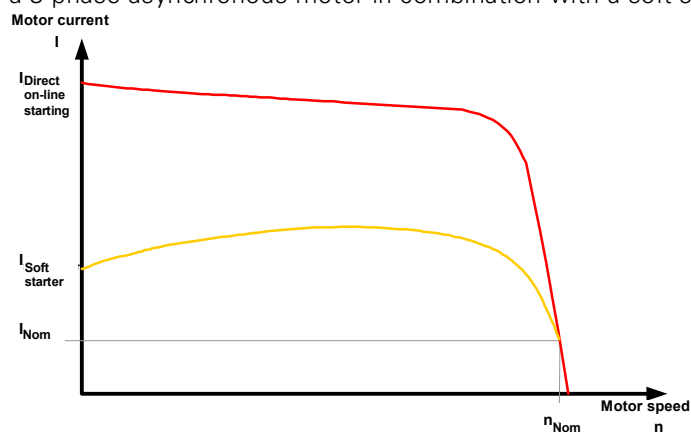

Fig. 1-3: Reduced current behavior of the 3-phase asynchronous motor during start-up with SIRIUS 3RW44 soft starter

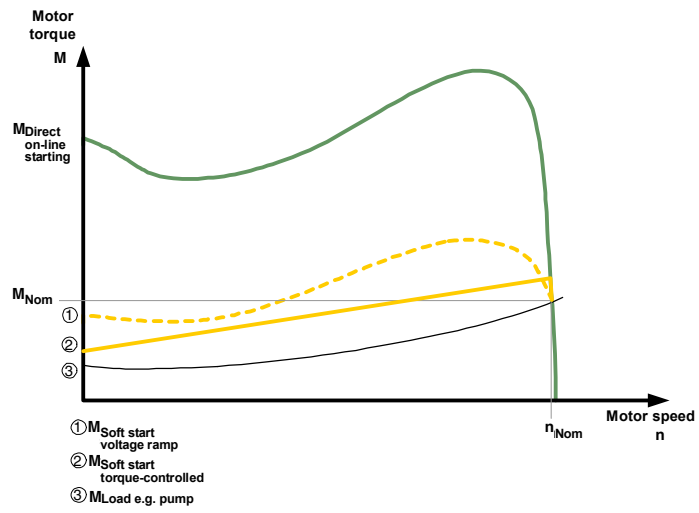

Fig. 1-4: Reduced torque behavior of the 3-phase asynchronous motor during start-up with SIRIUS soft starter 3RW44

**Starting**

This means that because the electronic soft starter controls the motor voltage during motor start-up, it simultaneously controls the ingoing starting current and the start torque generated in the motor.

The same principle is also used during the stopping process. The effect is that the torque generated in the motor is slowly reduced, thus enabling soft stopping of the application.

During this process, the frequency remains constant and corresponds to the network frequency, contrary to the frequency-controlled starting and stopping of a frequency converter.

Upon completion of motor start-up, the thyristors are fully utilized, resulting in the complete network voltage being applied to the motor terminals. Since no motor voltage control is required during operation, the thyristors are bridged by integrated bypass contacts. This reduces the waste heat developing during continuous operation which is caused by power loss of the thyristor. Therefore, the area around the switching devices heats up less.

The following graph illustrates the mode of operation of the 3RW44 soft starter:

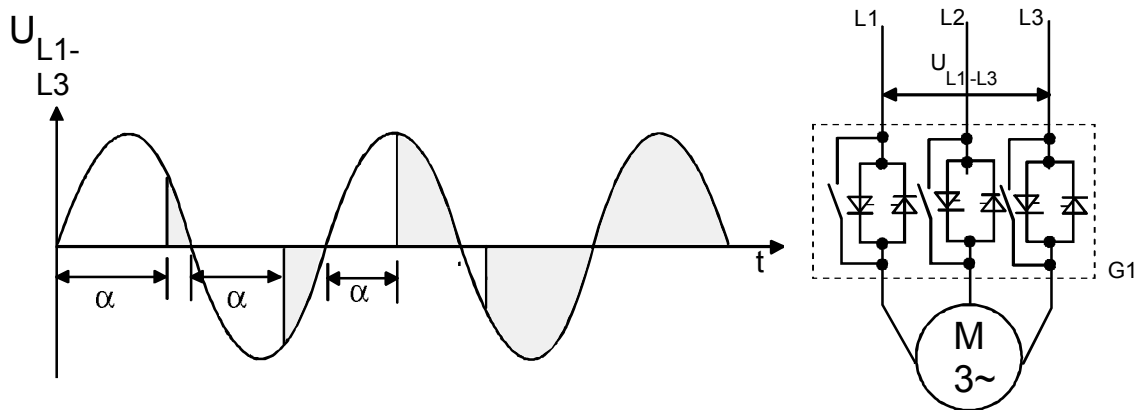

Fig. 1-5: Phase angle control and schematic layout of a soft starter with internal bypass contacts



---

## 1.2 Application and use

### Applications and selection criteria

The 3RW44 soft starters are an alternative for star-delta starters and frequency converters.

Their major benefits are smooth starting and stopping, uninterrupted changeover without current peaks that would stress the power supply, and their compact dimensions.

Numerous drives which so far could only be operated with frequency converters can be changed over to soft starter operation using the 3RW44 soft starter, as long as no speed control or particularly high start torque is required.

### Applications

Possible applications include:

- Conveyor belt
- Powered roller conveyors
- Compressors
- Ventilators
- Pumps
- Hydraulic pumps
- Stirrers
- Centrifugal machines
- Milling machines
- Mills
- Crushers
- Disk saws/ribbon saws
- ...

### Advantages

Conveyor belts and systems:

- Jerk-free starting
- Jerk-free braking

Centrifugal pumps, reciprocating pumps:

- Water hammering is avoided
- Increased service life of the tubing

Stirrers, mixers:

- Reduced starting current

Fans:

- Reduced stress on transmissions and V-belts

## 1.3 Boundary conditions for storage and operation

Permissible ambient temperature for	
- Storage	-25 °C ... +80 °C
- Operation	0 °C .. +60 °C, from 40 °C with derating (refer to chapter 9.3 Technical data)
Permissible relative air humidity	10 ... 95 %
Maximum permissible installation height	3000 m, from 1000 m with derating



### Caution

Please ensure that no liquid, dust or conductive parts enter the soft starter!

---

# Configuration instructions

# 2

Chapter	Subject	Page
2.1	Configuration	2-2
2.1.1	Serial PC interface RS 232 and Softstarter ES parameterizing and operating software	2-2
2.1.2	Win-SOFTSTARTER selection and simulation program	2-2
2.1.3	Training course for SIRIUS soft starters (SD-SIRIUSO)	2-2
2.2	Normal or heavy starting	2-3
2.2.1	Example applications for normal starting (Class 10)	2-3
2.2.2	Example applications for heavy starting (Class 20)	2-3
2.2.3	Example applications for heaviest starting (Class 30)	2-4
2.3	On-time and switching frequency	2-5
2.4	Installation height and ambient temperature	2-6
2.5	Factory setting	2-7

## 2.1 Configuration

The electronic 3RW44 soft starters are designed for normal starting. A model with higher output may be necessary for heavy starting or for a higher starting frequency.

A PTC thermistor in the motor is recommended for long starting times. This also applies to the soft stop, pump stop and DC braking stopping modes, since there is an additional current load in contrast to coasting down.

No capacitive elements (e.g. compensation systems) must be included in the motor branch between the soft starter and the motor. Active filters must not be operated in combination with soft starters.

All elements of the main circuit (such as fuses and switching devices) must be dimensioned for direct starting according to the local short-circuit conditions and should be ordered separately.

The harmonic load of the starting current must be taken into account when selecting circuit-breakers (release selection).

### 2.1.1 Serial PC interface RS 232 and Softstarter ES parameterizing and operating software

The electronic 3RW44 soft starters are fitted with a PC interface to communicate with the Softstarter ES smart software and with an operating and monitoring module.

### 2.1.2 Win-SOFTSTARTER selection and simulation program

This software allows all SIEMENS soft starters to be simulated and selected using various parameters such as network conditions, motor data, load data, special application requirements, etc.

The software is a powerful tool which makes time-consuming and complex manual calculations for determining the suitable soft starter a thing of the past.

The CD-ROM can be ordered using the following order number:

Order no.: E20001-D1020-P302-V2-7400.

### 2.1.3 Training course for SIRIUS soft starters (SD-SIRIUSO)

In order to keep customers and the company's own personnel up-to-date in terms of configuring, commissioning and maintenance, Siemens provides a two-day training course for the electronic SIRIUS soft starters.

You can enroll or direct any queries here:

Training Center  
I&S IS E&C TC  
Werner-von-Siemens-Str. 65  
91052 Erlangen, Germany  
Telephone: ++49 9131 729262  
Fax: ++49 9131 728172  
sibrain@erl9.siemens.de  
<http://www.siemens.de/sibrain>

## 2.2 Normal or heavy starting

To achieve the optimum soft starter layout, it is important to know and take into account the starting time (normal or heavy starting) of the application. Long starting times mean a higher thermal load for the thyristors of the soft starter. The 3RW44 soft starters are designed for continuous operation in the case of normal starting (Class 10), an ambient temperature of 40 degrees Celsius and a fixed switching frequency. You can also find these values in Section 9.3.2 Technical data power component. If deviations from these data occur, it may be necessary to overdimension the soft starter. Using the Win-SOFTSTARTER selection and simulation program from SIEMENS, you can enter your application data and requirements, and it will determine the optimum soft starter dimensions for your application (refer to Section 9.3.8 Accessories Software).

### Selection criteria

#### Notice

For the SIRIUS soft starter 3RW44, the corresponding soft starter must be selected according to the motor rated current (Rated current<sub>soft starter</sub> ≥ motor rated current).

### 2.2.1 Example applications for normal starting (Class 10)

**Normal starting Class 10** (up to 20 s with 350%  $I_{n \text{ motor}}$ ).

Selected soft starter output can be equal to the output of the motor used

Application	Conveyor belt	Powered roller conveyor	Compressor	Small fan	Pump	Hydraulic pump
<b>Starting parameter</b>						
• Voltage ramp and current limiting						
- Starting voltage	% 70	60	50	30	30	30
- Starting time	s 10	10	10	10	10	10
- Current limit value	Deactivated	Deactivated	4 x $I_M$	4 x $I_M$	Deactivated	Deactivated
• Torque ramp						
- Starting torque	60	50	40	20	10	10
- End torque	150	150	150	150	150	150
- Starting time	10	10	10	10	10	10
• Breakaway pulse	Deactivated (0 ms)	Deactivated (0 ms)	Deactivated (0 ms)	Deactivated (0 ms)	Deactivated (0 ms)	Deactivated (0 ms)
<b>Stopping mode</b>	Soft stop	Soft stop	Coasting down	Coasting down	pump stop	Coasting down

### 2.2.2 Example applications for heavy starting (Class 20)

**Heavy starting Class 20** (up to 40 s with 350%  $I_{n \text{ motor}}$ ).

The soft starter to be selected must be one output class higher than the motor used

Application	Stirrers	Centrifugal machines	Milling machines
<b>Starting parameter</b>			
• Voltage ramp and current limiting			
- Starting voltage	% 30	30	30
- Starting time	s 30	30	30
- Current limit value	4 x $I_M$	4 x $I_M$	4 x $I_M$
• Torque ramp			
- Starting torque	30	30	30
- End torque	150	150	150
- Starting time	30	30	30
• Breakaway pulse	Deactivated (0 ms)	Deactivated (0 ms)	Deactivated (0 ms)
<b>Stopping mode</b>	Coasting down	Coasting down	Coasting down or DC braking

### 2.2.3 Example applications for heaviest starting (Class 30)

**Heaviest starting Class 30** (up to 60 s with 350%  $I_{n, motor}$ ).

The soft starter to be selected must be two output classes higher than the motor used

Application	Large fan	Mill	Crusher	Disk saw/ribbon saw
<b>Starting parameter</b>				
• Voltage ramp and current limiting				
- Starting voltage	% 30	50	50	30
- Starting time	s 60	60	60	60
- Current limit value	$4 \times I_M$	$4 \times I_M$	$4 \times I_M$	$4 \times I_M$
• Torque ramp				
- Starting torque	20	50	50	20
- End torque	150	150	150	150
- Starting time	60	60	60	60
• Breakaway pulse				
	Deactivated (0 ms)	80 %; 300 ms	80 %; 300 ms	Deactivated (0 ms)
<b>Stopping mode</b>				
	Coasting down	Coasting down	Coasting down	Coasting down

#### Notice

These tables provide example set values and device dimensions. They serve as information only and are not binding. The set values are application-dependent and must be optimized during commissioning.

Soft starter dimensioning should, if required, be verified with the help of the Win-SOFTSTARTER program or via the Technical Assistance in Section Important notes .

## 2.3 On-time and switching frequency

In terms of motor rated current and normal/heavy starting, the 3RW44 soft starters are dimensioned for a maximum permissible switching frequency in combination with a relative on-time. Please also refer to Section 9.3.2 Technical data power component. If these values are exceeded, a larger soft starter dimension may need to be selected.

### On-time OT

The relative on-time OT in % corresponds to the relationship between the load duration and the switching-cycle period of loads that are frequently switched on and off.

The on-time OT can be calculated using the following formula:

$$ED = \frac{t_s + t_b}{t_s + t_b + t_p}$$

Explanation of the formula:

OT On-time [%]  
 ts Starting time [s]  
 to Operating time [s]  
 ti Idle time [s]

The following graphic illustrates the procedure.

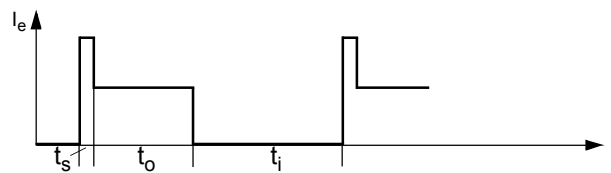

Fig. 2-1: On-time OT

### Switching frequency

To prevent thermal overloading of the devices, the maximum permissible switching frequency must be adhered under all circumstances.

## 2.4 Installation height and ambient temperature

The permissible installation height must not exceed 3000 m above sea level (above 3000 m on request).

If the installation height exceeds 1000 m, the rated current must be reduced for thermal reasons.

If the installation height exceeds 2000 m, the rated voltage must also be reduced because of the limited insulation strength. For installation heights between 2000 m and 5000 m above sea level, only rated voltages  $\leq 460$  V are allowed.

The following illustration shows the reduction of the rated device current in relation to the installation height:

From 1000 m above sea level, the rated operating current  $I_e$  must be reduced.

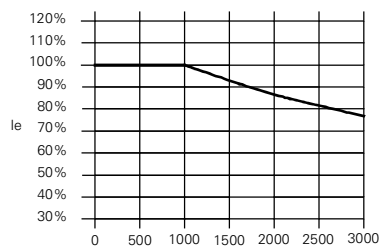

Fig. 2-2: Current reduction in relation to the installation height

### Ambient temperature

The 3RW44 soft starters are designed to be operated with a nominal current at an ambient temperature of 40° Celsius. If this temperature is exceeded, e.g. by excessive heating up in the switchgear cabinet, by other loads or by a higher general ambient temperature, this will influence the performance of the soft starter and must be taken into account in the dimensioning process (refer to Section 9.3.2 Technical data power component).



## 2.5 Factory setting

We recommend you apply the factory settings (default settings)

- in the event of faulty parameterization
- if SIRIUS 3RW44 soft starters that have already been parameterized are to be used further in other systems.

---

### **Notice**

If this is not done, drives may start running because of the present parameterization.

---

Soft starters already parameterized by the operator can be set back to the factory setting without additional auxiliary tools being needed.

For a reset to the factory setting, refer to Section 5.4.13 Saving options.



## Installation, connection and branch layout

# 3

Chapter	Subject	Page
3.1	Installing the soft starter	3-2
3.1.1	Unpacking	3-2
3.1.2	Mounting position	3-2
3.1.3	Standards	3-2
3.1.4	Mounting dimensions and clearances	3-3
3.2	Branch layout	3-4
3.2.1	General	3-4
3.2.2	Soft starters in standard circuits	3-5
3.2.3	Soft starter in inside delta circuits	3-6
3.2.4	Soft starter with contactor disconnecter (main contactor)	3-8
3.3	Protection of the soft starter against short circuits	3-9
3.4	Capacitors for power factor improvement	3-10
3.5	Electrical connection	3-10
3.5.1	Control and auxiliary current connection	3-10
3.5.2	Main current connection	3-11
3.5.3	Conductor cross-sections	3-12

## 3.1 Installing the soft starter

### 3.1.1 Unpacking

---

**Caution**

Do not lift the device by the lid when unpacking it, as this may damage the device.

---

### 3.1.2 Mounting position

The unit should be mounted on vertical, level surfaces.

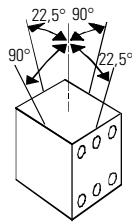

Fig. 3-1: Mounting position

### 3.1.3 Standards

**Degree of protection  
IP00**

The 3RW44 soft starters comply with degree of protection IP00.

Taking into account the ambient conditions, the devices must be installed in IP54 switchgear cabinets (degree of protection 2).

Make sure that no liquids, dust or conductive parts can enter the soft starter.

Operation of the soft starter produces waste heat (heat loss) (refer to Chapter 9 General technical data).

---

**Caution**

Ensure sufficient cooling where the unit is installed to prevent the switching device from overheating.

---

### 3.1.4 Mounting dimensions and clearances

For uninhibited cooling, ventilation and venting of the heat sink, it is essential that the minimum clearance from other devices is strictly observed.

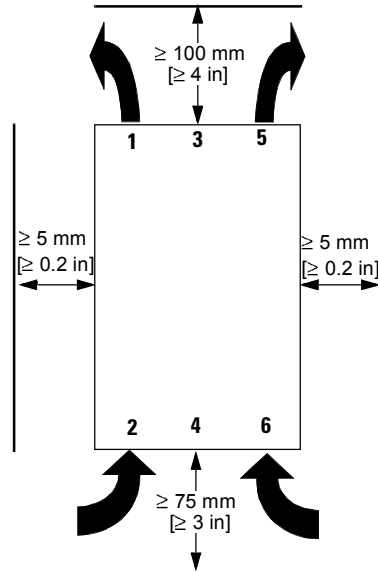

Fig. 3-2: Clearance with other devices

#### Notice

Cater for sufficient clearance to ensure that air can freely circulate for cooling. The unit is ventilated from bottom to top.

## 3.2 Branch layout

---



### **Warning** **Automatic restart.**

May result in death, serious injury or damage to property. The automatic reset mode must not be used in applications where the unexpected restart of the motor may lead to personal injury or damage to property. The start command (e.g. by the PLC) must be reset before a reset command, since an automatic restart is executed when a start command is pending after the reset command. This especially applies to motor protection tripping. For safety reasons it is recommended to integrate the group fault output (terminals 95 and 96) into the control.

---

### 3.2.1 General

A motor branch consists of at least a **disconnecter**, a **switching element** and a **motor**.

Protection functions should include line protection against short circuits and overload protection for line and motor.

#### **Disconnecter**

The disconnecting function with line protection against overload and short circuits can be achieved by using, for example, a circuit-breaker or a fuse disconnecter.

(For fuse and circuit-breaker assignment, refer to Chapter 9.3.6 Branch component layout (standard circuit) and Chapter 9.3.7 Branch component layout (inside delta circuit). The 3RW44 soft starter provides the switching element function and motor protection.

---



### **Danger**

If supply voltage is applied to the input terminals of the soft starter, there may be dangerous voltages at the soft starter output even without a start command! When working on the branch, it must be disconnected using a disconnecter (open isolating gap, e.g. with a repair switch)!

---

### 3.2.2 Soft starters in standard circuits

The SIRIUS 3RW44 soft starter is connected in the motor branch between the disconnecter or circuit-breaker and the motor.

The 3RW44 soft starter automatically detects the connection type of the soft starter so this does not have to be explicitly set on the device. The detected connection type can be shown on the starter under the menu item **status display/ connection type**; in this case the display shows **star/delta**. If the circuitry is faulty or the motor is not connected, the display shows **unknown**.

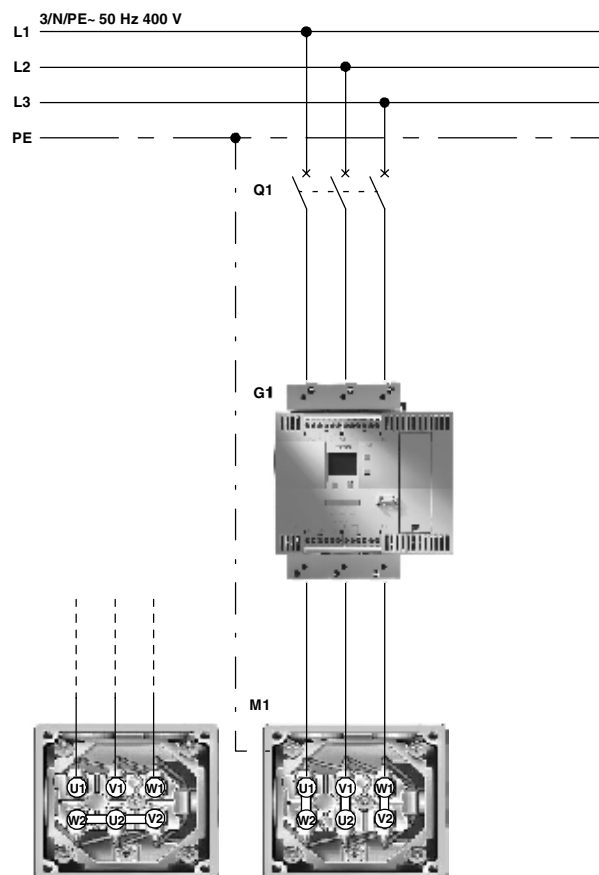

Fig. 3-3: Block diagrams for 3RW44 soft starters in standard circuit

#### Notice

If a main or line contactor is used, this contactor must not be connected between the soft starter and the motor or in the return line between the motor and the soft starter. Otherwise the soft starter would not recognize the current circuit version (standard circuit or inside delta circuit) and output an error message: "missing load phase 1-3", i.e. ensure that the circuit is closed before the 3RW44 is activated.

### 3.2.3 Soft starter in inside delta circuits

**Prerequisite** A motor whose windings can be connected in a delta circuit where line voltage prevails.

**Example**

Supply voltage:	400 V
Rated motor current:	40.5 A
Current via soft starter in inside delta circuit:	approx. 24 A
Selected soft starter in inside delta circuit:	3RW44 22



Fig. 3-4: Name plate of a 22 kW motor

Here the SIRIUS 3RW44 soft starter can be dimensioned to match the current flowing in the motor section (58 % of the conductor current) by connecting it in the delta winding of the motor. This requires at least 6 motor lines.

The 3RW44 soft starter automatically detects how it is connected so the connection type does not have to be explicitly set on the device. The detected connection type can be read off on the starter under the menu item **Status display/ connection type**, in this case the display reads **Inside delta circuit**. If the circuitry is faulty or the motor is not connected, the display reads **Unknown**.

---

**Notice**

The rated motor current given on the name plate should always be set in the quickstart menu or in the motor adjustment menu item. This setting is independent of the type of connection of the soft starter.  
Value to be set in the above example for a supply voltage of 400 V, e.g. 40.5 A.

---



**Notice**

The DC braking and combined braking device functions are no longer available for inside delta circuits.

In order to ensure proper functioning of the soft starter, the electric connection of the main voltage (line and motor side) must be made according to the given circuit examples (refer to Section 8.1).

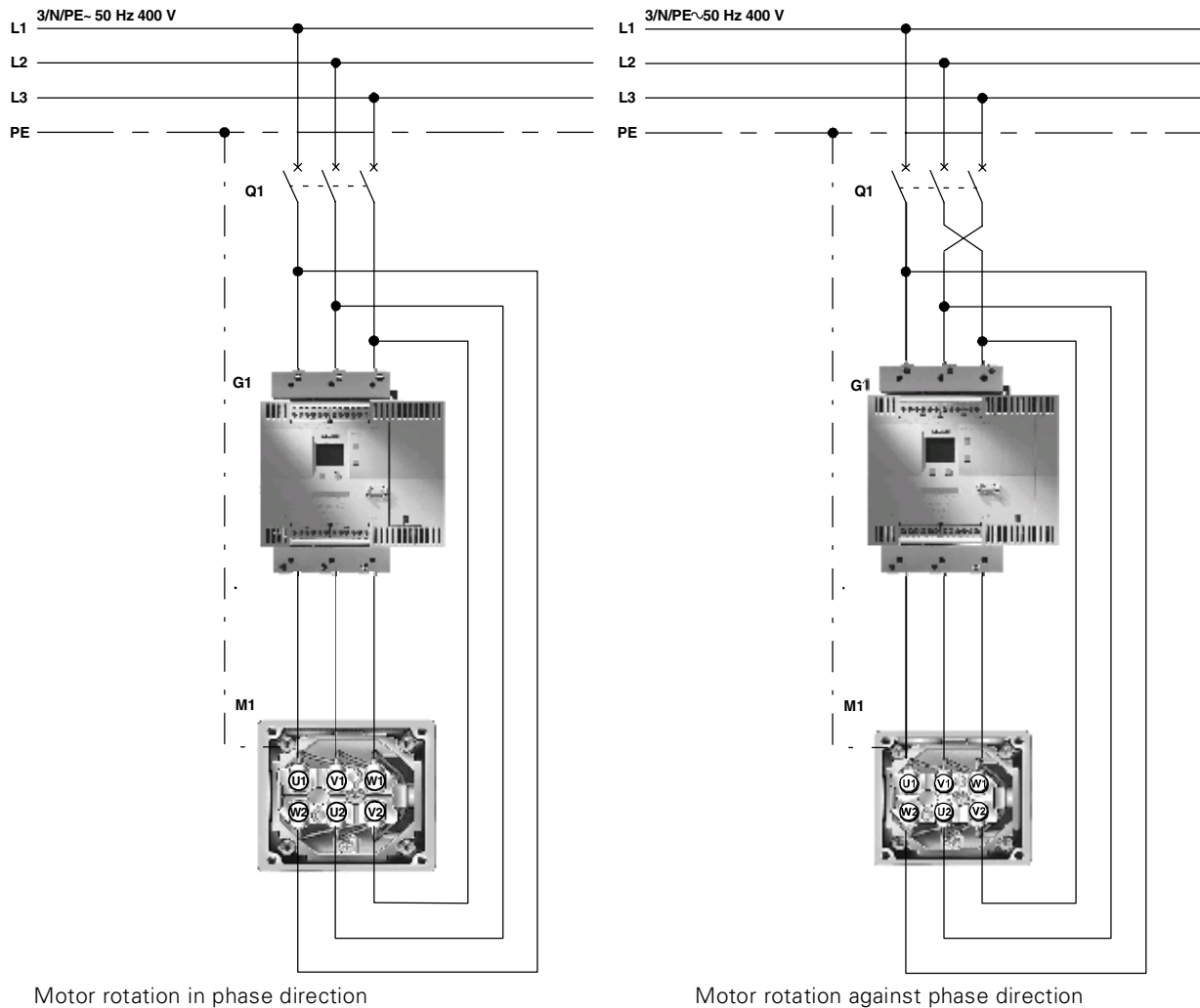

Fig. 3-5: Block diagram of a 3RW44 soft starter in an inside delta circuit

**Notice**

If a main or line contactor is used, this contactor must not be connected between the soft starter and the motor or in the return line between the motor and the soft starter. Otherwise the soft starter would not recognize the current circuit version (standard circuit or inside delta circuit) and output an error message: "load phases 1-3 missing".

### 3.2.4 Soft starter with contactor disconnector (main contactor)

If galvanic decoupling is required, a motor contactor can be installed between the soft starter and the disconnector, or a fault output relay can be used. (Refer to Chapter 9.3 Technical data for the contactor assignment)

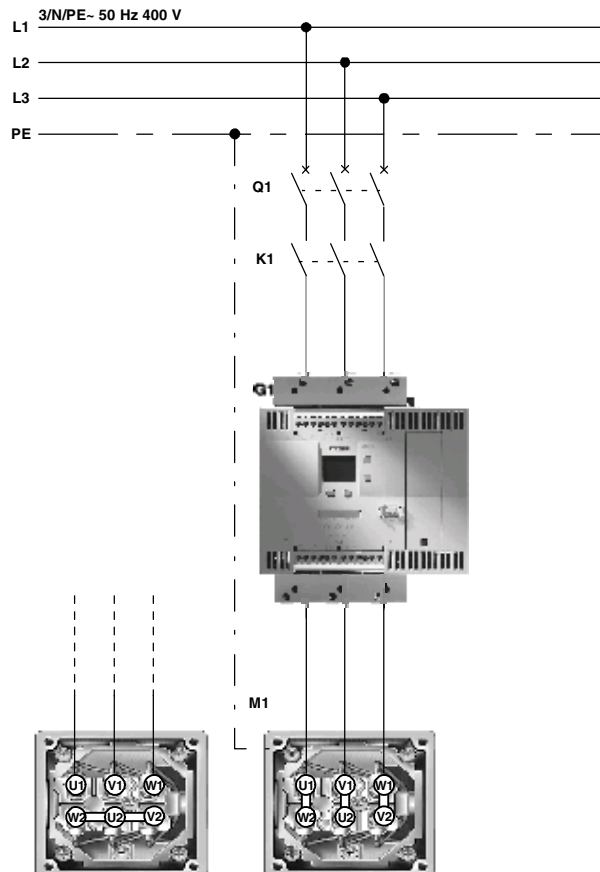

Fig. 3-6: Block diagram of branch with optional main contactor/contacter disconnector

---

#### Notice

If a main or line contactor is used, this contactor must not be connected between the soft starter and the motor or in the return line between the motor and the soft starter. Otherwise the soft starter would not recognize the current circuit version (standard circuit or inside delta circuit) and output an error message: "load phases 1-3 missing".

---

### 3.3 Protection of the soft starter against short circuits

The soft starter has integrated thyristor protection against overloading. In the event of a short circuit, e.g. due to a defect in the windings of the motor or a short circuit via the motor supply cables, this internal thyristor protection function is not sufficient. To suit this purpose, special semiconductor fuses, e.g. SITOR fuses from SIEMENS, must be used.

(Refer to Chapter 9.3 Technical data for the fuse assignment)

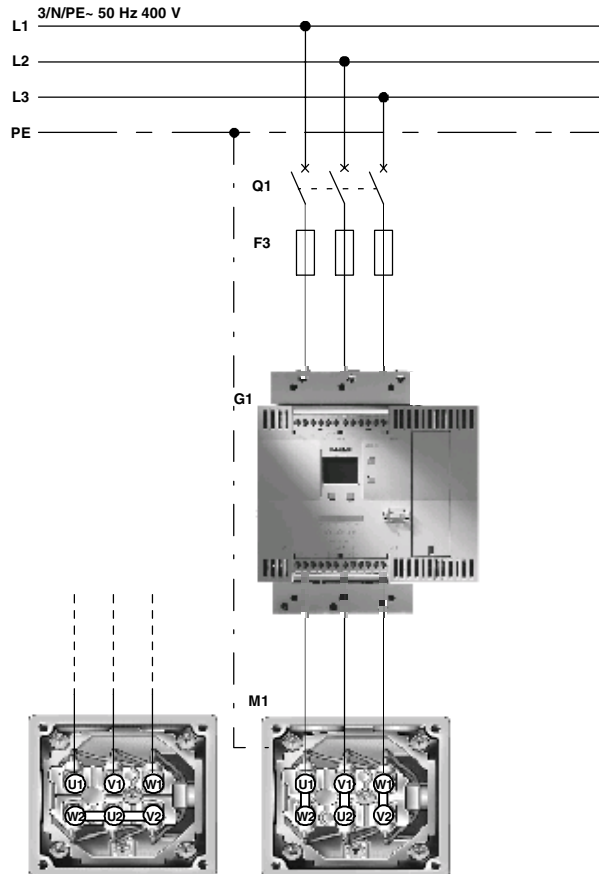

Fig. 3-7: Block diagram of branch with semiconductor fuses

## 3.4 Capacitors for power factor improvement

---



### Caution

Do not connect any capacitors to the output terminals of the soft starter. If you do, the soft starter will be damaged. Active filters, e.g. for reactive power compensation, must not be operated in parallel while the motor control device is operational.

---

If capacitors for reactive power compensation are used, they must be connected on the line side of the device. If a contactor disconnect or a main contactor is used in combination with the electronic soft starter, the capacitors must be disconnected from the soft starter when the contactor is open.

## 3.5 Electrical connection

### 3.5.1 Control and auxiliary current connection

The SIRIUS 3RW44 soft starter is supplied with two different connection types:

- Screw-type connection
- Spring-loaded terminals

Two control voltage versions are available:

- 115 V AC
- 230 V AC

### 3.5.2 Main current connection

All soft starters are equipped with busbar connections for the main current connection.

#### Size 3RW44 2.

An additional box terminal for direct cable connection is supplied as standard with size 3RW44 2. units.

#### Sizes 3RW44 3. and 3RW44 4.



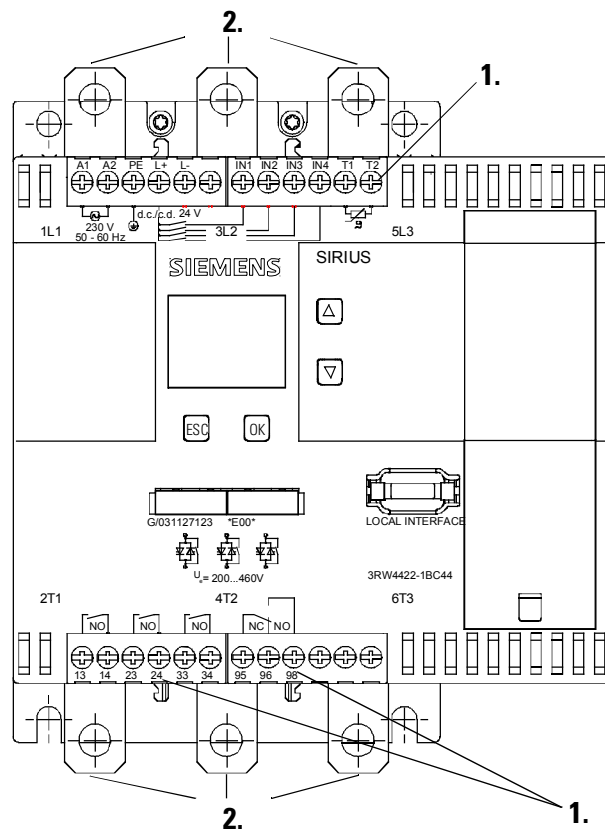



For size 3RW44 3. and 3RW44 4. units it is possible to retrofit box terminals as optional accessories (refer to Chapter 9.3.8 Accessories).













1.	A1, A2, PE, L+, L, IN1, IN2, IN3, IN4, T1, T2, 13, 14, 23, 24, 33, 34, 95, 96, 98: Main/auxiliary circuit
2.	L1/L2/L3, T1/T2/T3: Main circuit

Fig. 3-8: Connections

### 3.5.3 Conductor cross-sections

A1, A2, PE, L+, L-, IN1, IN2, IN3, IN4, T1, T2, 13, 14, 23, 24, 33, 34, 95, 96, 98			
3RW44..-1.... 3RW44..-6....		3RW44..-2.... 3RW44..-3.... 	
 Ø 5 ... 6 mm / PZ2	0.7 ... 0.9 Nm 7 ... 8 lb-in	 DIN 5264-A	
 10	2 x (0.5 ... 2.5 mm <sup>2</sup> ) 2 x AWG 20 ... 14	 10	2 x (0.25 ... 2.5 mm <sup>2</sup> ) 2 x AWG 24 ... 14
 10	2 x (0.5 to 1.5 mm <sup>2</sup> ) 2 x AWG 20 ... 16	 10	2 x (0.25 ... 1.5 mm <sup>2</sup> )

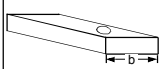
L1, L2, L3; T1, T2, T3					
3RW44 2.-....		3RW44 3.-....		3RW44 4.-....	
	2 x 10 ... 70 mm <sup>2</sup> 2 x AWG 7 ... 1/0	M8x25	10 ... 14 Nm 89 ... 124 lb-in	M10x30	14 ... 24 Nm 124 ... 210 lb-in
	2 x 10 to 50 mm <sup>2</sup> 2 x AWG 7 ... 1/0		2 x 25 ... 120 mm <sup>2</sup> 2 x AWG 4 ... 250 kcmil		2 x 70 ... 240 mm <sup>2</sup> 2 x AWG 2/0 ... 500 kcmil
 17	2 x 2.5 ... 16 mm <sup>2</sup>		2 x 16 ... 95 mm <sup>2</sup> 2 x AWG 6 ... 3/0		2 x 50 ... 240 mm <sup>2</sup> 2 x AWG 2/0 ... 500 kcmil
 17	2 x 2.5 ... 35 mm <sup>2</sup> 1 x 2.5 ... 50 mm <sup>2</sup>	min. 3 x 9 x 0.8 max. 10 x 15.5 x 0.8			
 17	2 x 10 ... 50 mm <sup>2</sup> 1 x 10 ... 70 mm <sup>2</sup> 2 x AWG 10 ... 1/0 1 x AWG 10 ... 2/0		b ≤ 17 mm		b ≤ 25 mm
 min 22	4 ... 6 Nm 36 ... 53 lb-in				

## Display, controls and device interfaces

# 4

Chapter	Subject	Page
4.1	Display and controls	4-2
4.2	Device interfaces	4-3
4.2.1	Local device interface	4-3
4.2.2	Profibus interface (optional)	4-3

## 4.1 Display and controls

### Graphical display

A graphical display on the front of the device provides information about the functions and statuses of the soft starter via plain text and symbols when a control voltage is applied.

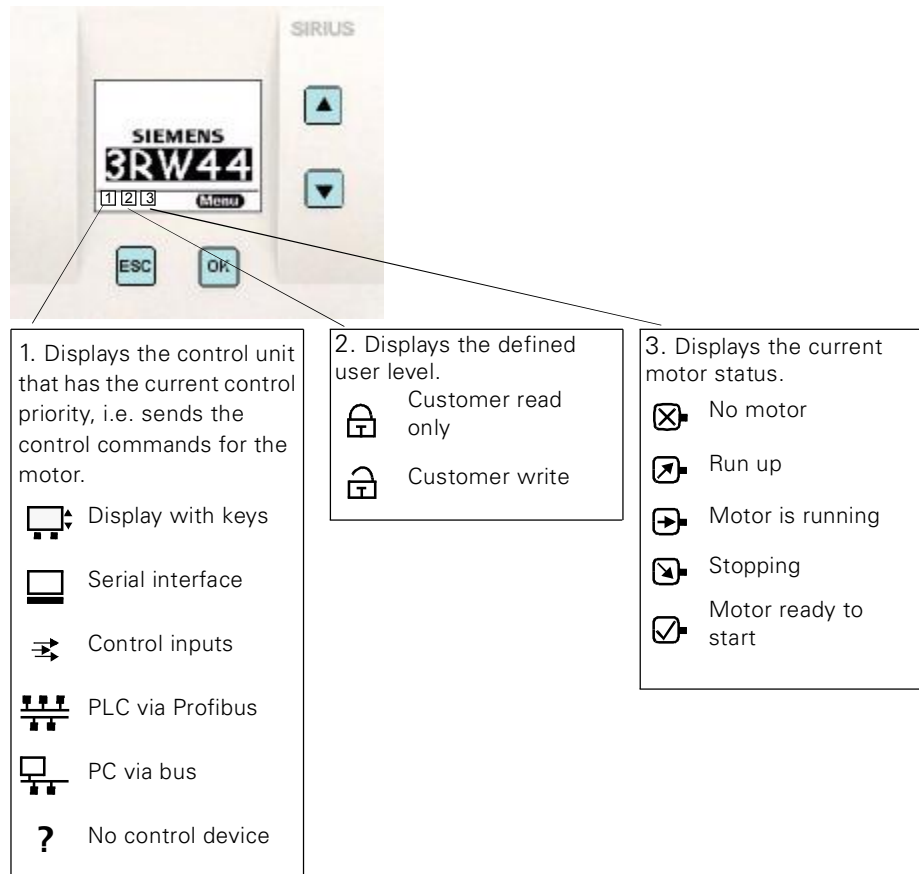





Fig. 4-1: Key to symbols

### Controls

There are four keys for operation and adjustment of the soft starter:

- 

The present function, which is dependent on the menu item, is shown as text on the display above this key (e.g. select menu, change value or save settings).
- 

The up/down keys are used to navigate through the menu items or to change number values in the settings menu item.
- 

The ESC key is used to quit the current menu item and to jump back to the higher-level menu item.



## **4.2 Device interfaces**

### **4.2.1 Local device interface**

A local device interface on the front side of the starter is provided as standard. This interface can be used to connect either an optional external operating and display module (refer to Chapter 9.3.8 "Accessories" ), or the "Softstarter ES smart" operating, monitoring and parameterizing software (refer to Chapter 9.3.8 "Accessories" , Software) using a PC and connecting cables.

### **4.2.2 Profibus interface (optional)**

The SIRIUS 3RW44 soft starter can be fitted with an optional Profibus module (only with product delivery after 12/05). The soft starter can be connected to the Profibus, operated and parameterized via the interface. The "Softstarter ES professional" operating, monitoring and parameterizing software (refer to Chapter 9.3.8 "Accessories" , Software) can also be connected to this interface using a PC and connecting cables.



# Commissioning

# 5

Chapter	Subject	Page
5.1	Menu structure, navigation, changing parameters	5-2
5.1.1	Menu structure and navigation	5-2
5.1.2	Changing parameters: for example motor data	5-3
5.2	Switching on for the first time	5-4
5.2.1	Quick start menu	5-4
5.3	User-specific commissioning	5-6
5.3.1	“Settings” main menu item	5-7
5.4	Making settings in the selected parameter set	5-8
5.4.1	Select parameter set	5-8
5.4.2	Entering motor data	5-9
5.4.3	Determining the starting mode	5-10
5.4.4	Determining the stopping mode	5-16
5.4.5	Setting slow speed parameters	5-19
5.4.6	Determining current limits	5-19
5.4.7	Parameterization of the inputs	5-20
5.4.8	Parameterization of the outputs	5-20
5.4.9	Selection of motor protection settings	5-22
5.4.10	Selection of display settings	5-23
5.4.11	Determining the protective functions	5-24
5.4.12	Determining the names on the device display	5-24
5.4.13	Saving options	5-25
5.5	Other device functions	5-28
5.5.1	Measured value display	5-28
5.5.2	Status display	5-29
5.5.3	Motor control (assign control priority)	5-30
5.5.4	Safety (define user level, parameterization protection)	5-30

## 5.1 Menu structure, navigation, changing parameters

The 3RW44 functions (parameterization, diagnosis and motor control) can be executed using the four control keys. The menu has various sublevels which are handled in different ways but are self-explanatory.

### 5.1.1 Menu structure and navigation

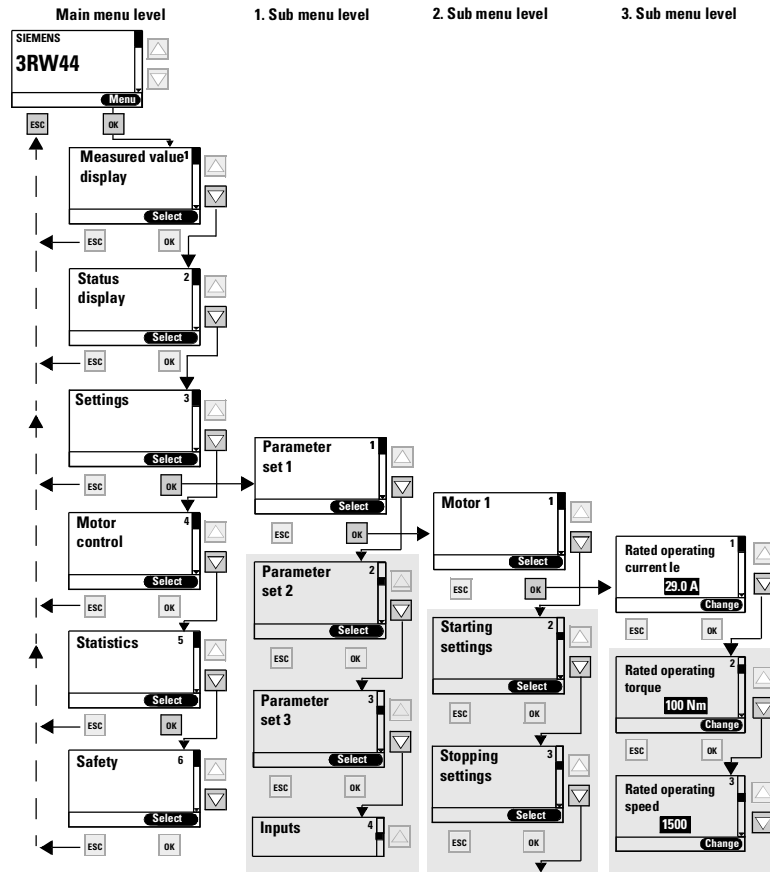

Fig. 5-1: Menu structure

## 5.1.2 Changing parameters: for example motor data

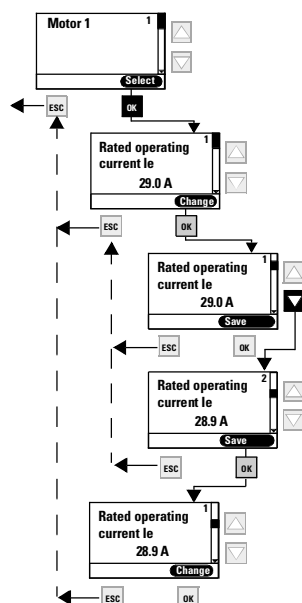

Fig. 5-2: Changing values, e.g. adjusting motor data

## 5.2 Switching on for the first time

---



### Warning

Before switching the unit on for the first time, verify that the main/control side is wired properly. Make sure that the supply and control voltage comply with the device-specific requirements (refer to Chapter 9.3 Technical data).

---

### 5.2.1 Quick start menu

---

#### Important

After applying the control supply voltage for the first time, you will automatically be in the quick start menu which you must go through once for to commission the soft starter for the first time.

---

In the quick start menu you need to enter information to preset the most important parameters of the soft starter for the application. Starting parameters that are typical of the application are stored in the device parameters.

To achieve an optimum motor start, these parameters may need to be optimized in relation to the connected load by using the **Settings** menu item, as described in Chapter 5.4.3 Determining the starting mode .

If you are unable to find your load among the available suggestions, select any load and optimize the defined parameters using the **Settings** menu item as described in Chapter 5.4.3 Determining the starting mode if required.

The factory values of the parameters as well as the predefined assignment of the control inputs and outputs can be found in Chapter 9.3 Technical data.

If you confirm the last item **Save settings - Run?** with **Yes** in the quick start menu, you can only return to this menu by resetting the device back to the factory setting (refer to Chapter 2.5 Factory setting). This overwrites all settings made up until that point.

## Quick start menu

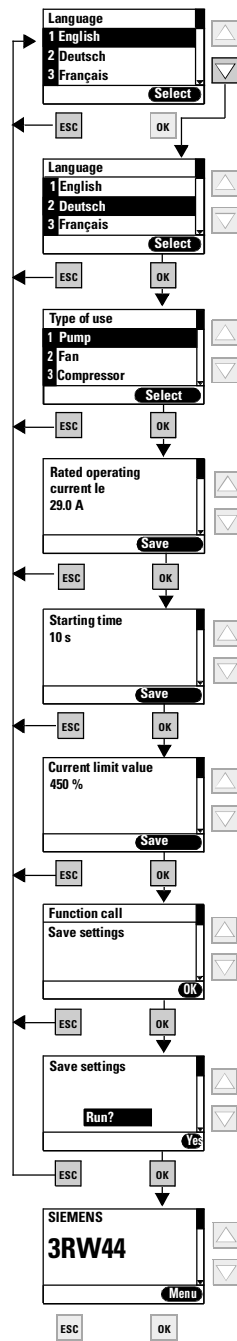

Fig. 5-3: Quick start menu

## 5.3 User-specific commissioning

If other values are required than the defined parameters in the quick start menu or in the factory settings of the 3RW44, please proceed as follows:

Under the menu item **Settings** (refer to Chapter 5.3.1 "Settings" main menu item), select:

1. Select parameter set
2. Set motor data
3. Set starting mode and parameters
4. Set stopping mode and parameters
5. Set inputs and outputs
6. Check motor protection settings
7. Save settings

---

### Notice

The setting is buffered in a Flash E-Prom memory as soon as you change a setting in the menu and execute it using the **OK key**. It is then active in the soft starter from this moment onwards. When the control supply voltage is switched off, this value will be canceled and the previous value be restored. In order to permanently save the settings made in the soft starter, you must save the data as described in Chapter 5.3.1 "Settings" main menu item and Chapter 5.4.13 Saving options.

---



### 5.3.1 "Settings" main menu item

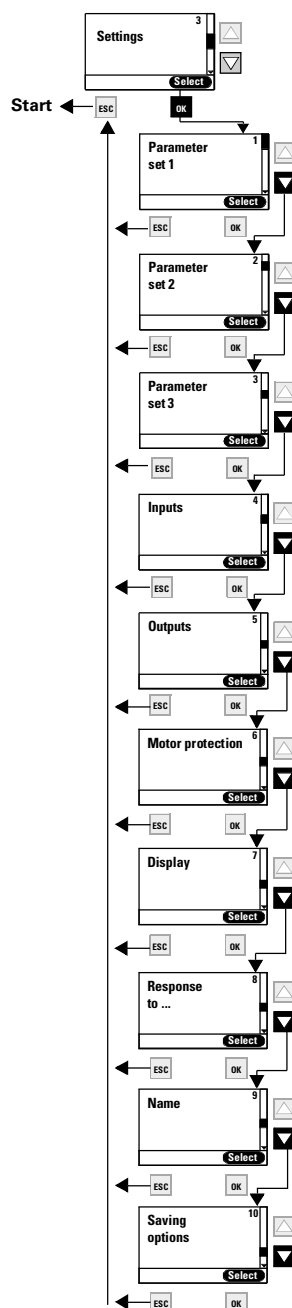

Fig. 5-4: Main menu item settings

## 5.4 Making settings in the selected parameter set

### 5.4.1 Select parameter set

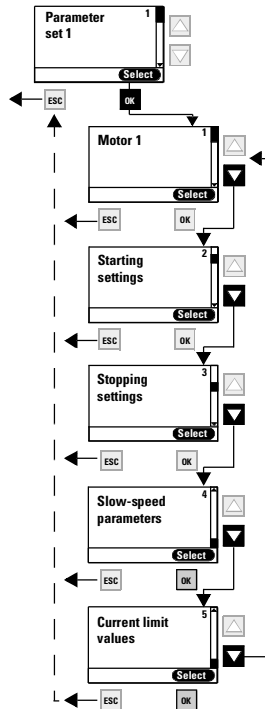

Fig. 5-5: Select parameter set

### 5.4.2 Entering motor data



Fig. 5-6: Entering motor data and the name plate

#### Rated torque

#### Notice

Always set the motor rated current that is indicated on the name plate with respect to the prevailing line voltage. This setting is independent of the connection method of the soft starter (soft starter in standard or inside delta circuit).

Value to be set in the above example for a supply voltage of 400 V, e.g. 40.5 A.

If the rated torque of the motor is not indicated on the name plate, it can be calculated using the following formula:

$$M = 9,55 \times P \times \frac{1000}{n}$$

#### Example

$$9,55 \times 22\text{kW} \times \frac{1000}{1470 \text{ min}^{-1}} = 143 \text{ Nm}$$

If no value is specified, the value of the factory setting is active (0 Nm).

With the start command and the motor connected, the soft starter evaluates the value required itself.

#### Notice

If a motor with rated data (current, speed, torque) that is different to the values already entered is connected to the soft starter (e.g. for testing purposes), these rated data must be adapted to this new motor. If 0 Nm is entered as rated torque, the value is automatically calculated once by the soft starter.

### 5.4.3 Determining the starting mode

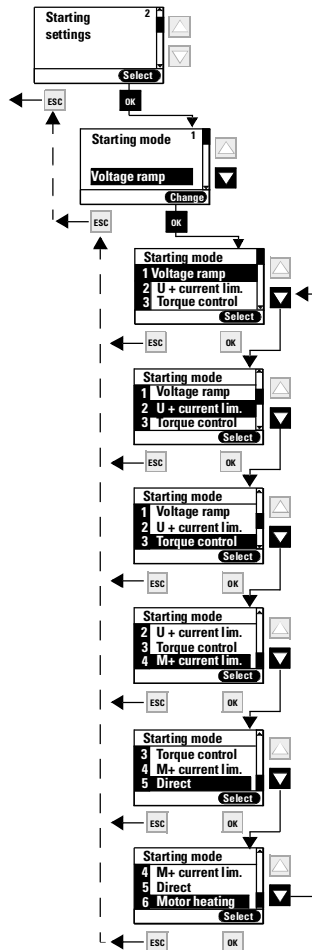

Fig. 5-7: Determining the starting mode

### Voltage ramp starting mode

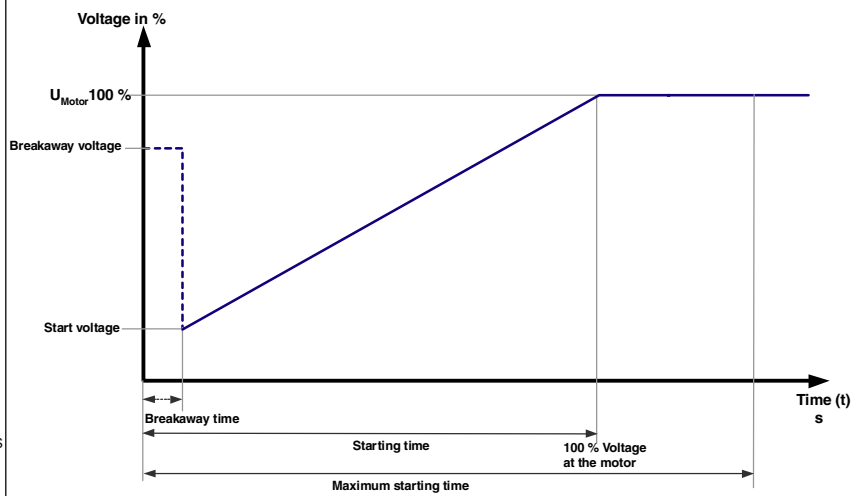
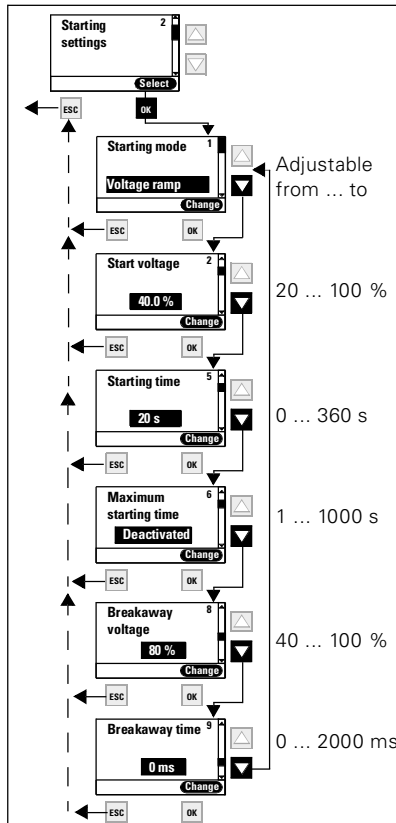

Fig. 5-8: Voltage ramp

Starting mode: voltage ramp with current limiting

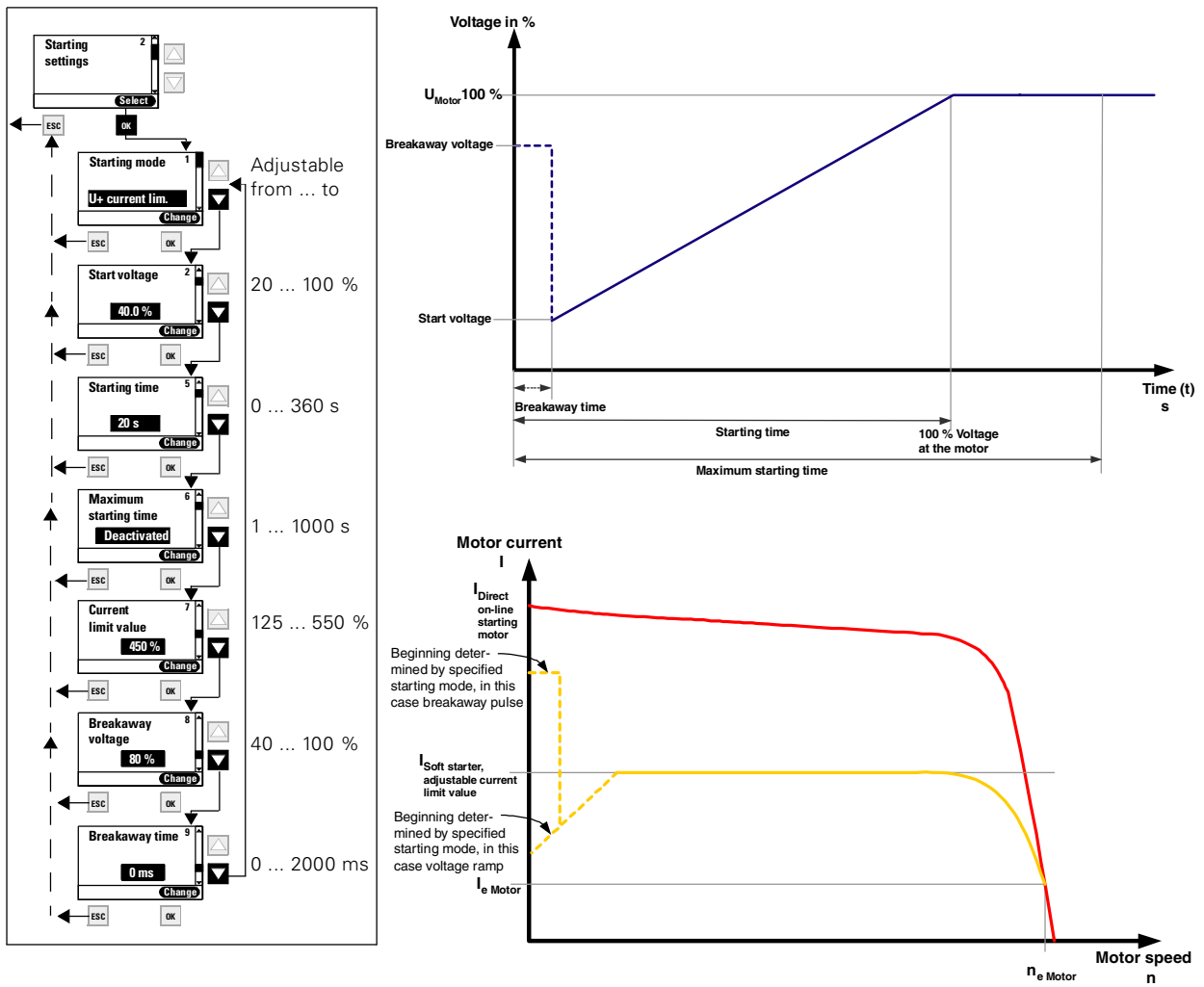

Fig. 5-9: Voltage ramp and current limiting

Starting mode: torque control

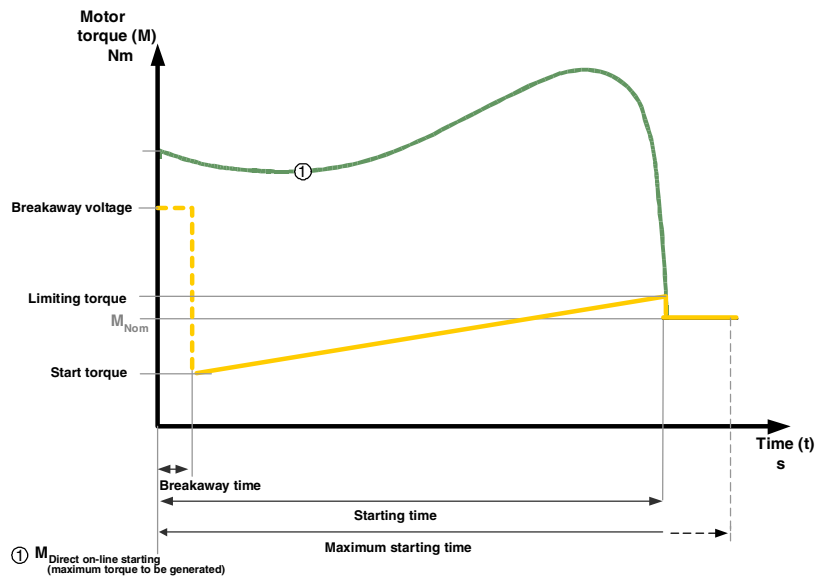
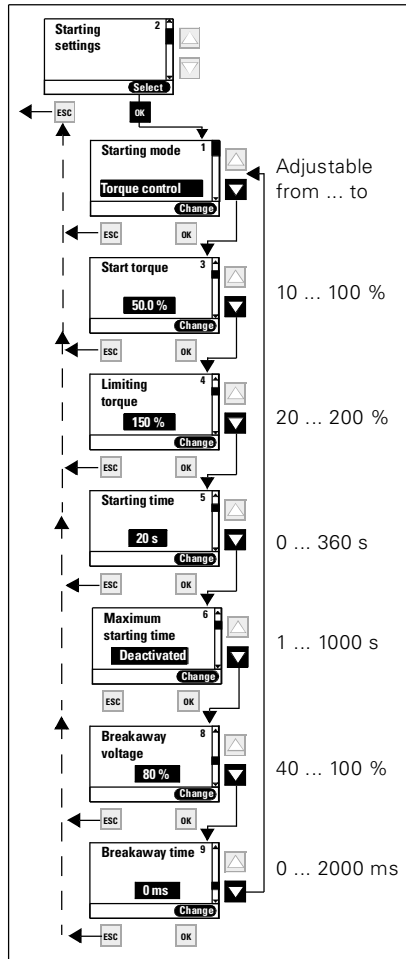

Fig. 5-10: Torque control

Starting mode: torque control with current limiting

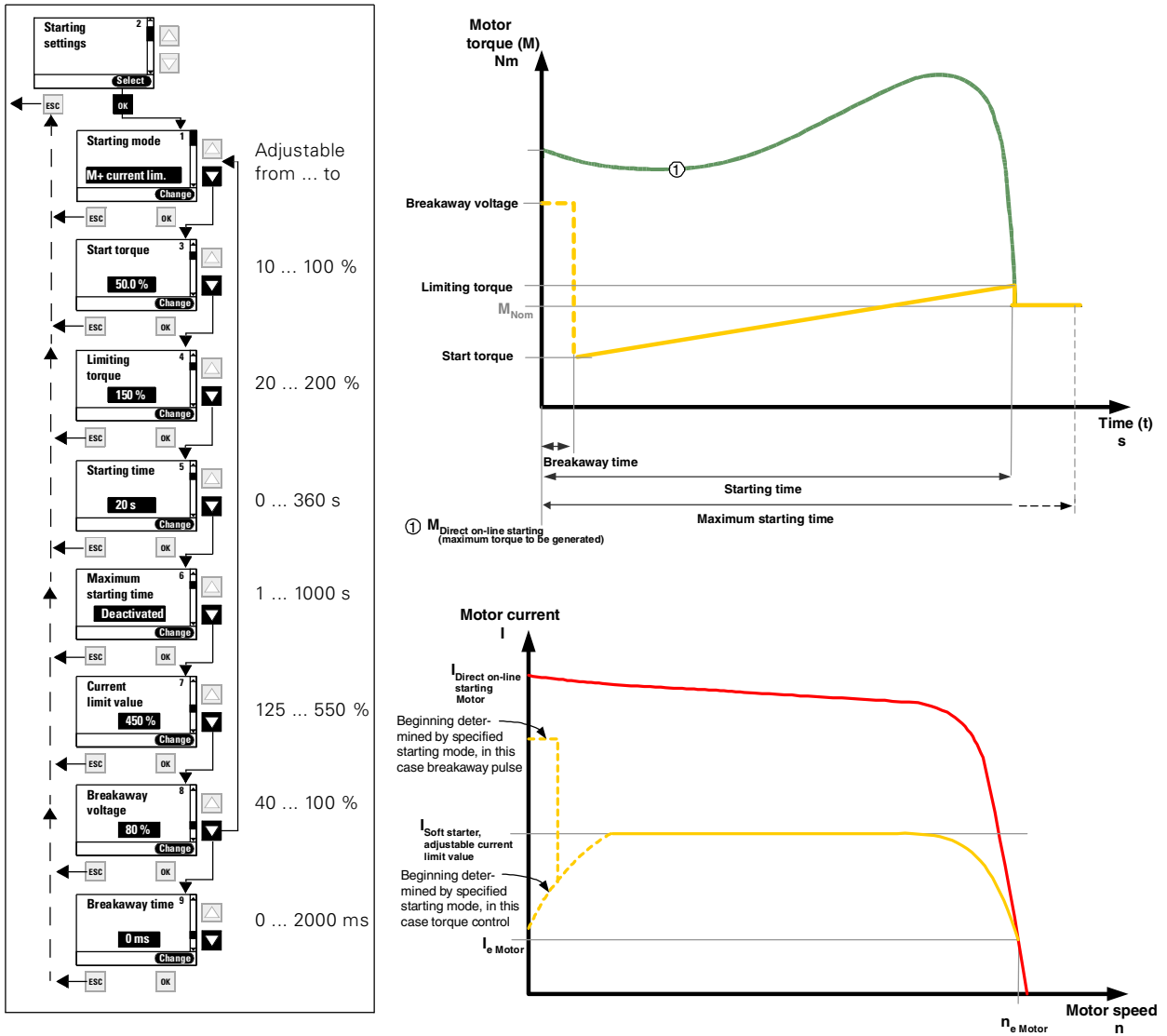

Fig. 5-11: Torque control with current limiting



**Starting mode: direct on-line**

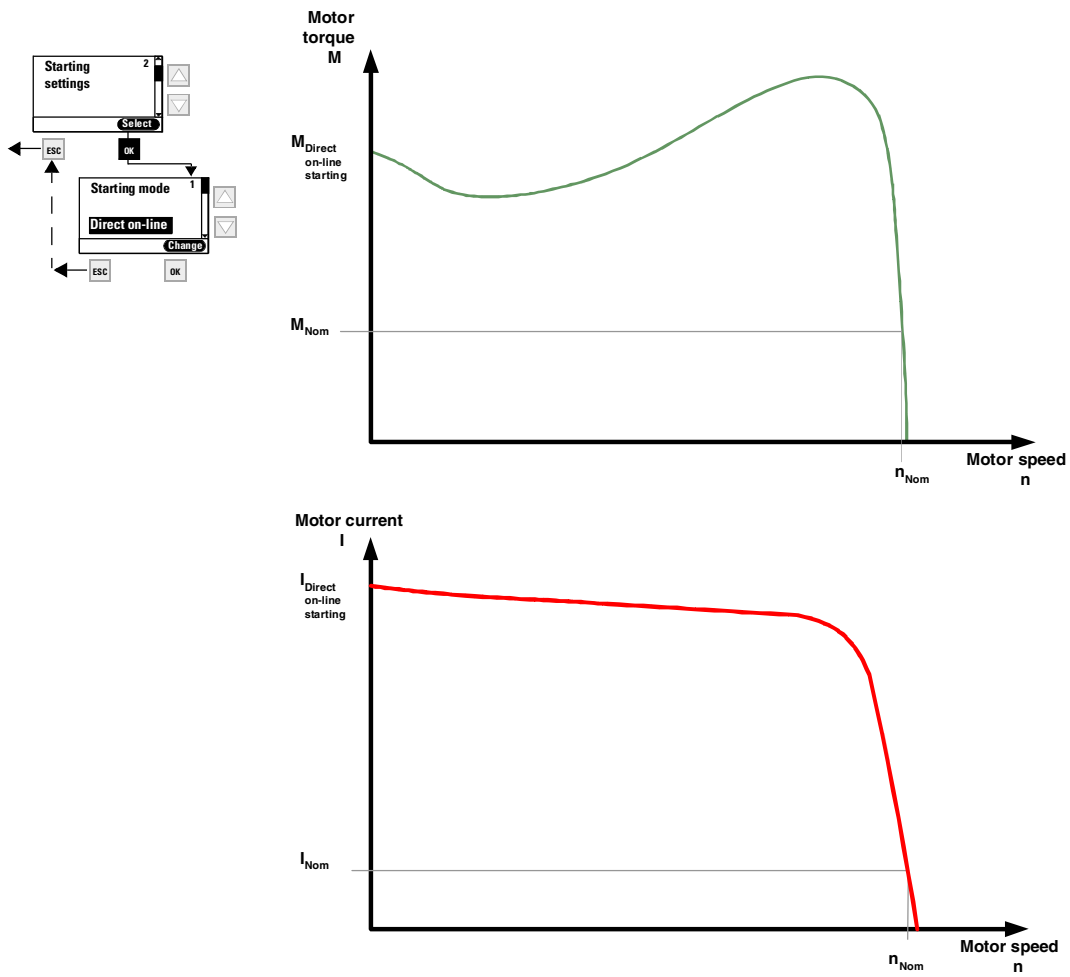

Fig. 5-12: Direct on-line starting

**Starting mode: motor heating**

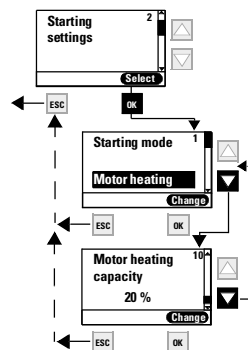

Fig. 5-13: Motor heating

### 5.4.4 Determining the stopping mode

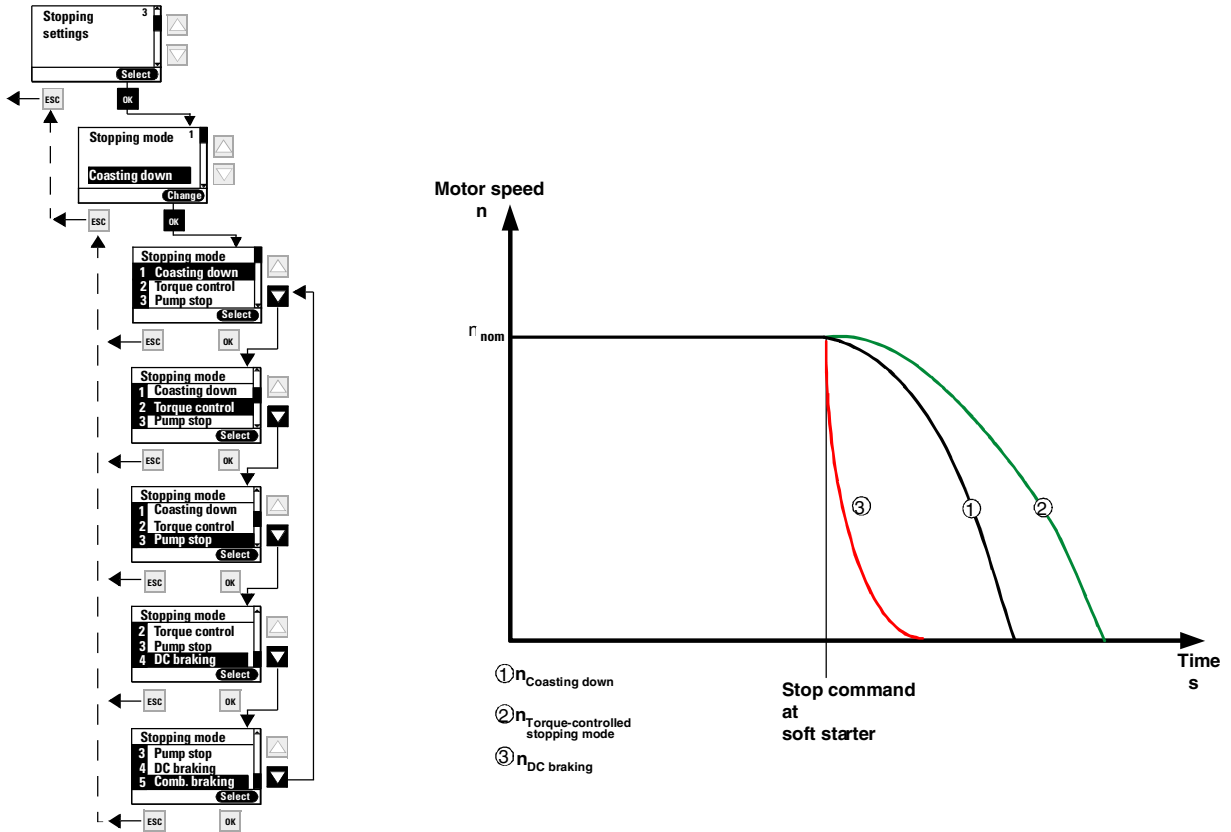

Fig. 5-14: Determining the stopping mode

#### Stopping mode: coasting down

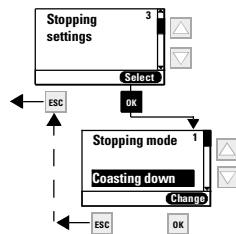

Fig. 5-15: Stopping mode: coasting down

### Stopping mode: torque control (soft stop)

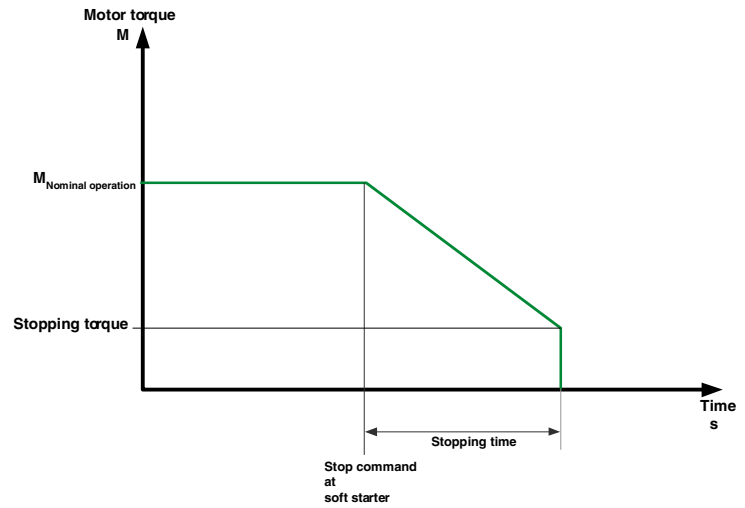
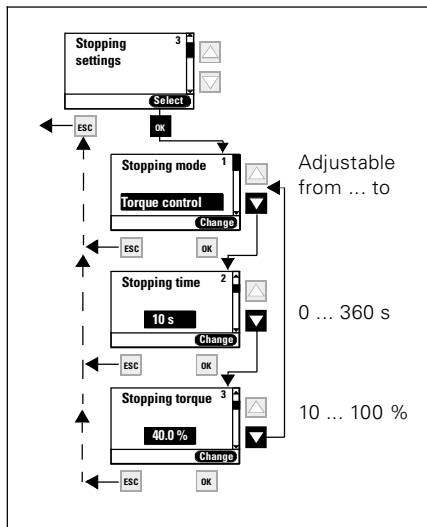

Fig. 5-16: Stopping mode: torque control

### Stopping mode: pump stop

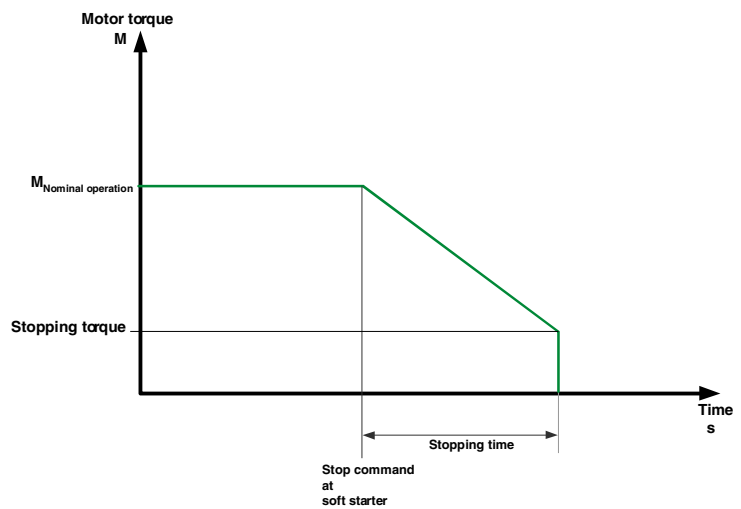
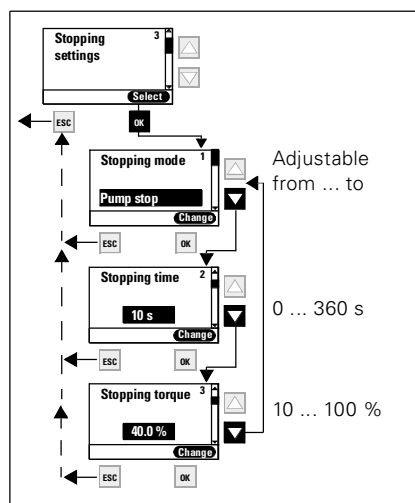

Fig. 5-17: Stopping mode: pump stop

**Stopping mode: DC braking**

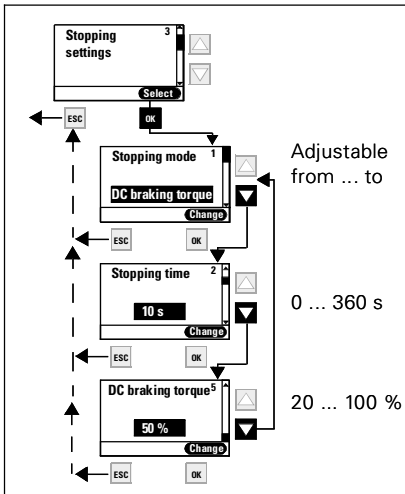
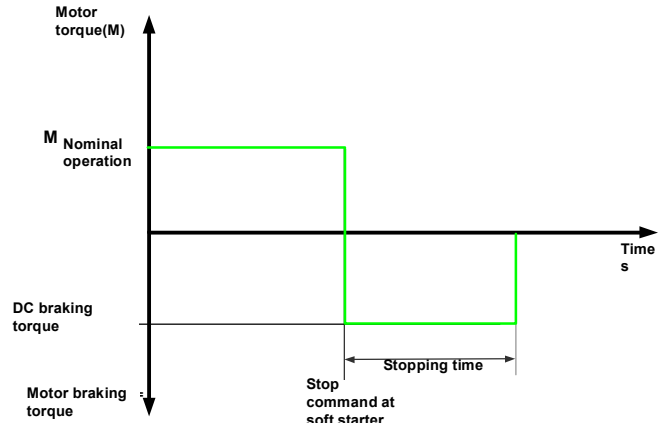

Fig. 5-18: DC braking torque



**Notice**

If the **DC braking** function is selected, the **DC brake contactor** function must be assigned to one output of the soft starter. This output is used to control an external brake contactor.

**Stopping mode: combined braking**

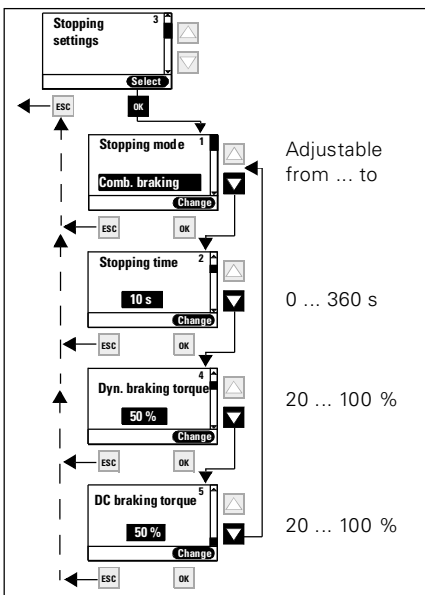
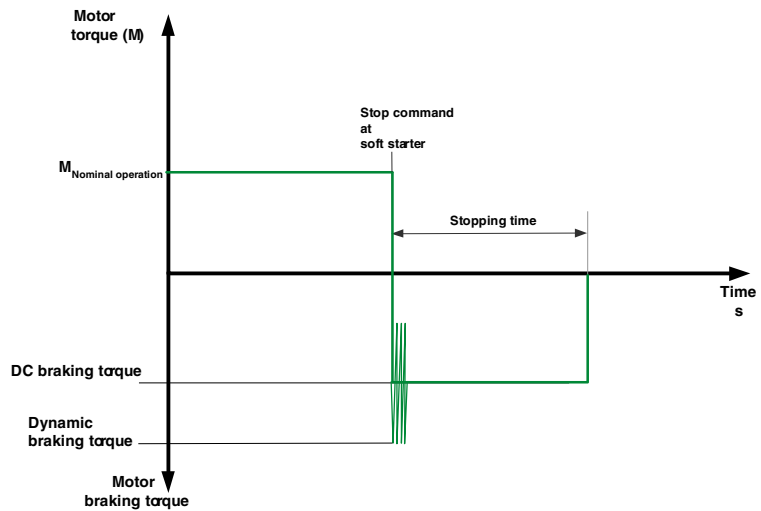
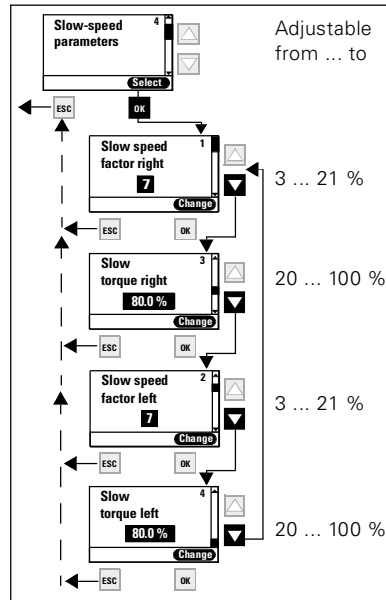

Fig. 5-19: Combined braking



### 5.4.5 Setting slow speed parameters



**Notice**

To control the motor with the specified slow speed parameters, "slow speed" must be assigned to one control input, and "motor right PS1/2/3" or "motor left PS1/2/3" must be assigned to the other control input. Also refer to circuit suggestion in 8.1.7.

Directions of rotation:

- Right: rotation in line phase direction
- Left: rotation against line phase direction

Fig. 5-20: Selection of slow speed settings

### 5.4.6 Determining current limits

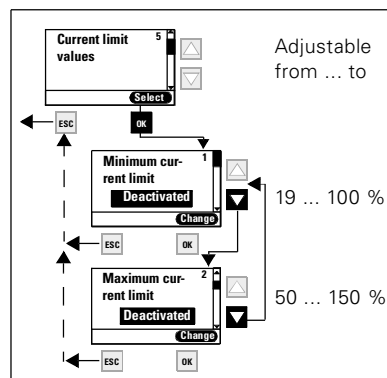
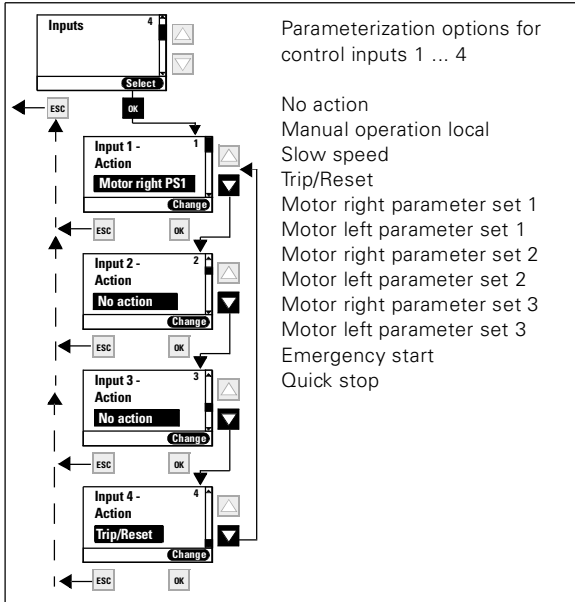

Fig. 5-21: Determining current limits

### 5.4.7 Parameterization of the inputs



**Notice**

The parameters "motor left parameter set 1/2/3" are active only when the "slow speed" parameter is active at the same time.

Directions of rotation:

Right: rotation in line phase direction

Left: rotation against line phase direction

If one action is assigned to two inputs, both of the inputs must be connected to carry out the selected function (e.g. to obtain logical "AND" linking for a start command, assign the "motor right PS1" function to input 1 and 2. A start command is only accepted if both inputs are active.).

Fig. 5-22: Parameterization of the inputs

### 5.4.8 Parameterization of the outputs

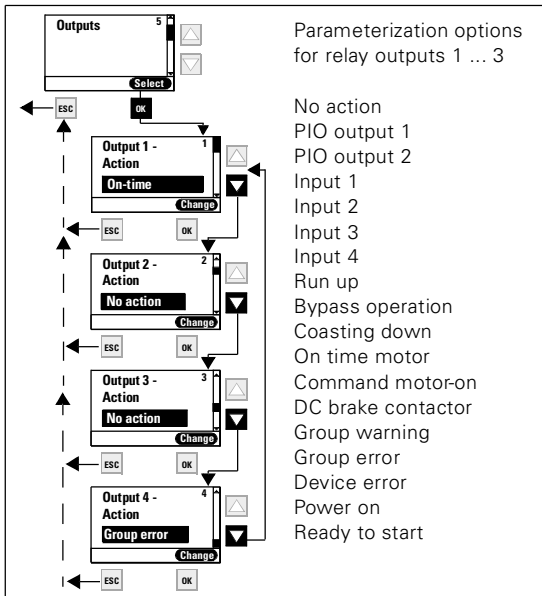
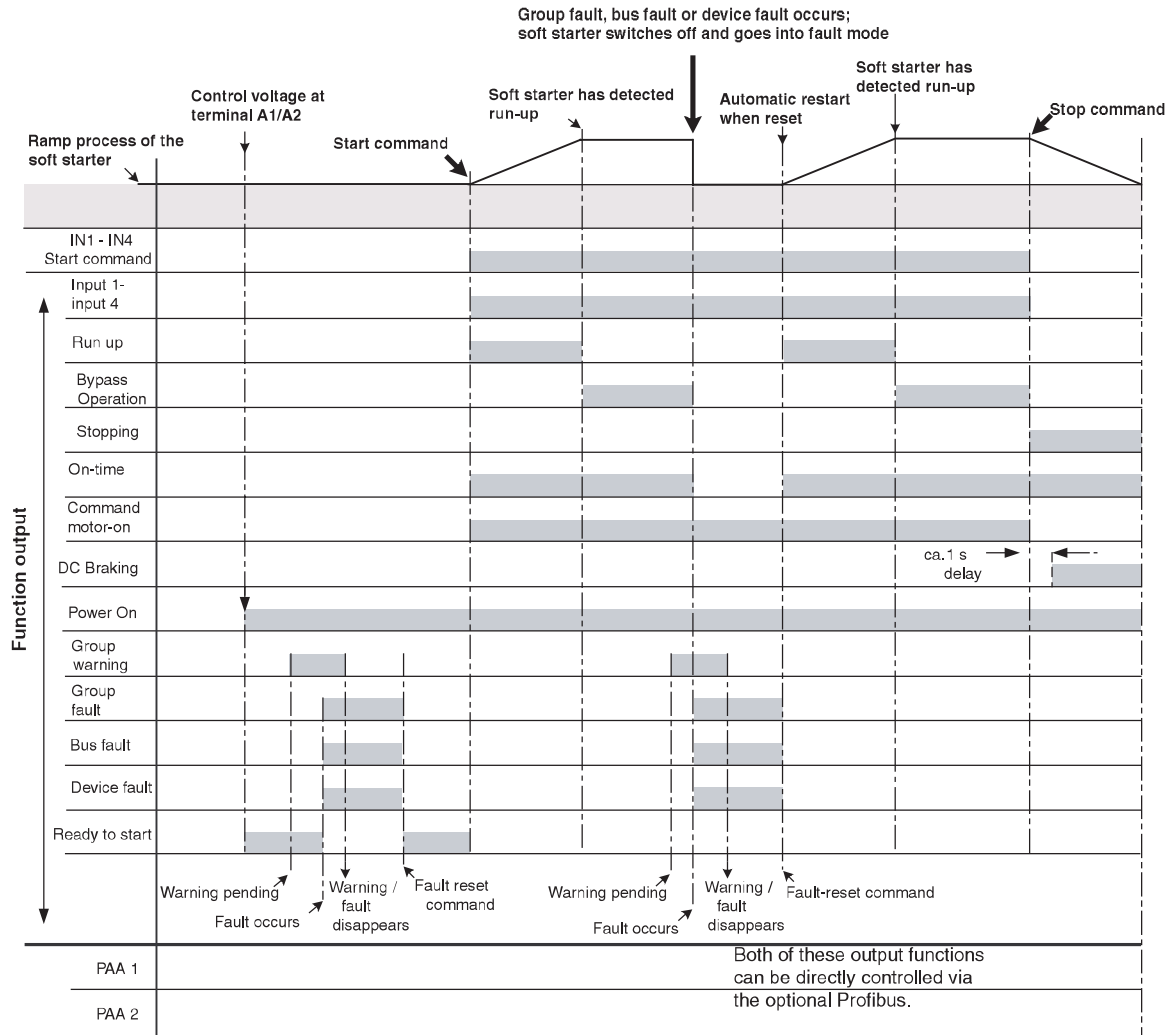

Fig. 5-23: Parameterization of the outputs

Status diagram of the outputs



### 5.4.9 Selection of motor protection settings

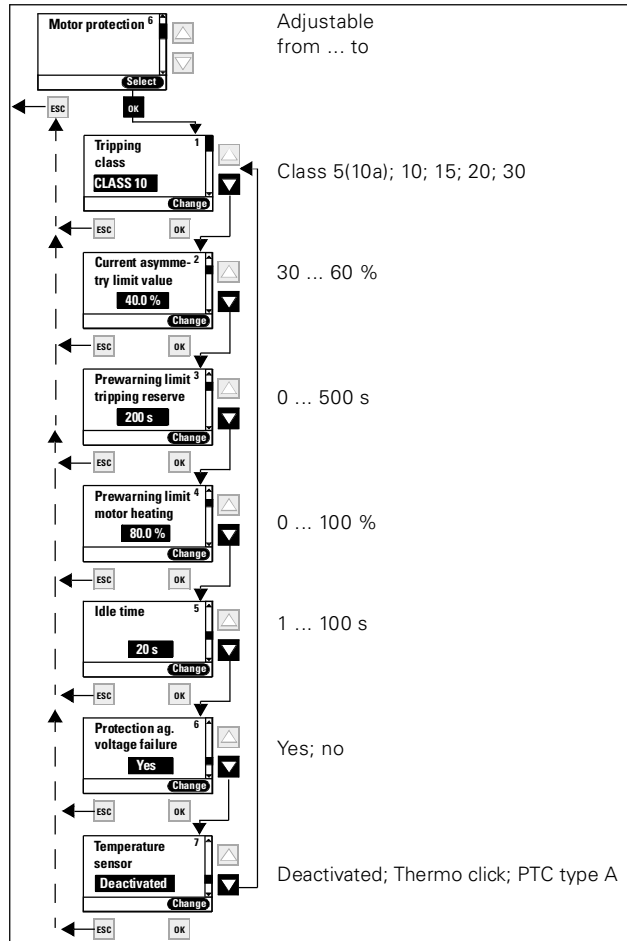

Fig. 5-24: Selection of motor protection settings



### 5.4.10 Selection of display settings

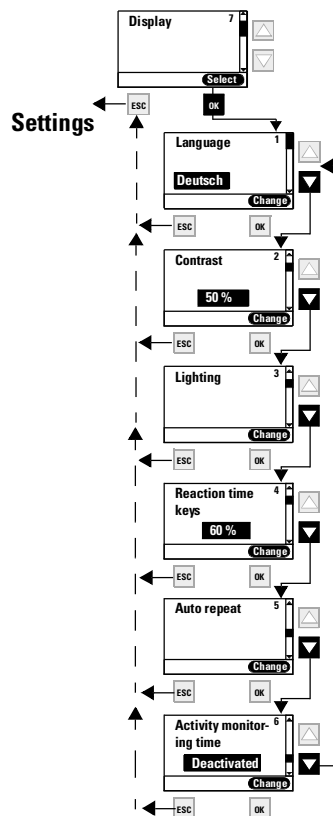

Fig. 5-25: Selection of display settings

### 5.4.11 Determining the protective functions

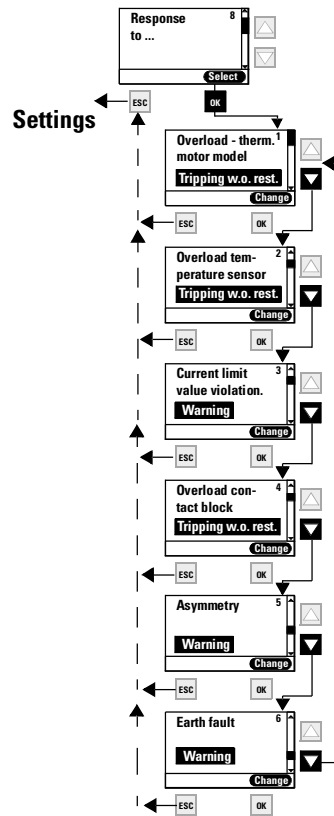

Fig. 5-26: Determining the protective functions

### 5.4.12 Determining the names on the device display

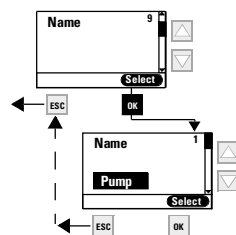

Fig. 5-27: Determining the names on the device display

### 5.4.13 Saving options

#### Determining the saving options

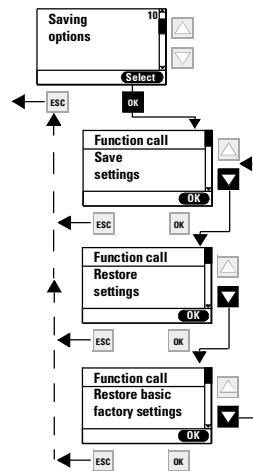

Fig. 5-28: Determining the saving options

#### Save settings

Selected settings will be saved.

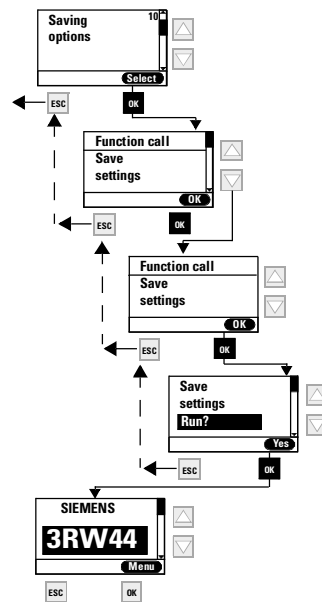

Fig. 5-29: Save settings

## Restoring settings

Selected but not saved settings will be discarded and the previous settings will be restored.

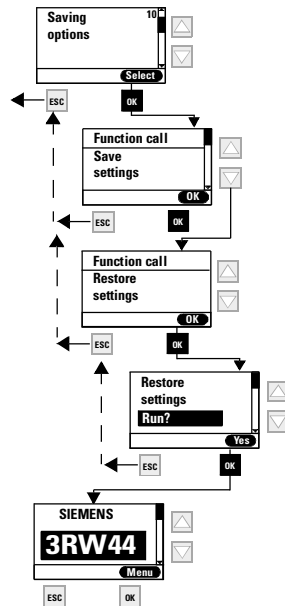

Fig. 5-30: Restoring settings

## Restoring the factory settings

All settings made or saved so far will be discarded and the device will be reset to the factory settings (master reset). The quick-start menu must be executed once again.

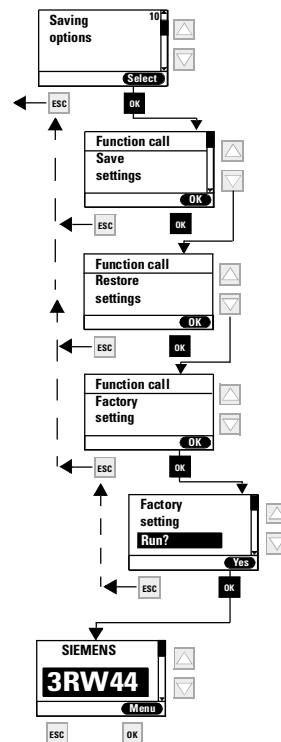
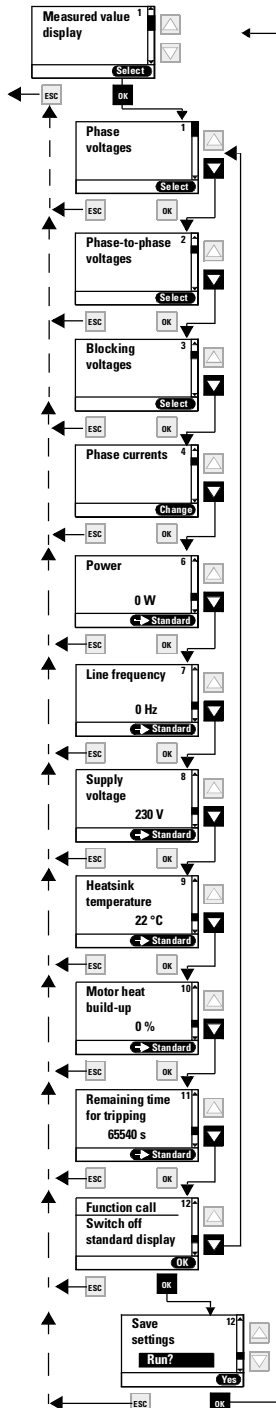

Fig. 5-31: Restoring factory settings

## 5.5 Other device functions

### 5.5.1 Measured value display



#### Notice

The "phase currents" display always shows the currents in the supply cable. That is, if the soft starter is operated in the circuit type "inside delta circuit", the currents measured internally by the soft starter are extrapolated to the supply cable current (phase current) by a factor of 1.73 and displayed.

Due to asymmetries, the phase currents in the inside delta circuit may deviate from the currents running through the supply cables.

## 5.5.2 Status display

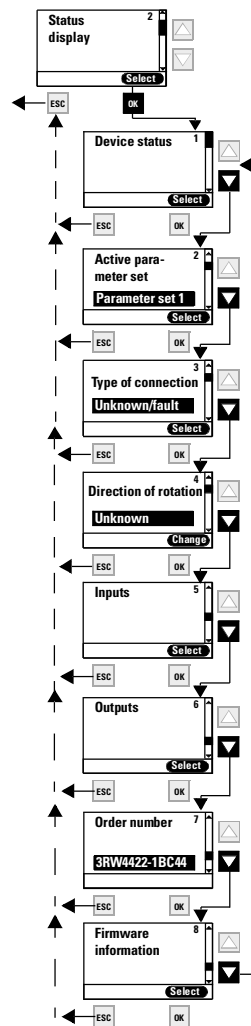
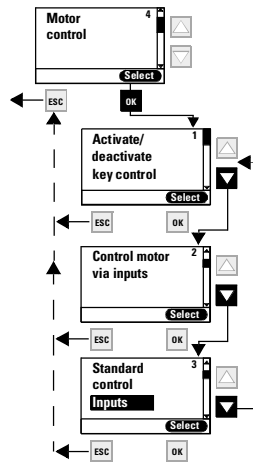

Fig. 5-32: Status display

### 5.5.3 Motor control (assign control priority)



**Notice**

The "standard control" menu item specifies which control device should be the master control device when the control supply voltage is applied. For Profibus operation, this parameter must be changed to "Automatic/none".

**Control device priority**

Only a higher-priority control device can assume and hand over the control priority (0=lowest).

- 0: Automatic operation
- 1: PC via Profibus (Softstarter ES professional software required)
- 2: Inputs
- 3: Using display keys (Softstarter ES smart software required)
- 4: PC via serial interface

Fig. 5-33: Motor control

### 5.5.4 Safety (define user level, parameterization protection)

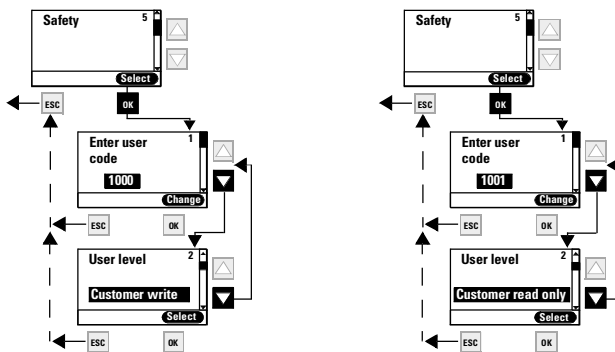

Fig. 5-34: Safety



# Device functions

# 6

Chapter	Subject	Page
6.1	Various parameter sets	6-2
6.2	Starting modes	6-3
6.2.1	Voltage ramp	6-3
6.2.2	Torque control	6-5
6.2.3	Breakaway pulse in combination with voltage ramp or torque control starting mode	6-7
6.2.4	Current limiting in combination with voltage ramp or torque control starting mode	6-9
6.2.5	Starting mode: direct on-line	6-10
6.2.6	Starting mode: motor heating	6-10
6.3	Stopping modes	6-11
6.3.1	Coasting down	6-11
6.3.2	Torque control and pump stop	6-12
6.3.3	DC braking / combined braking	6-13
6.4	Slow speed function	6-16
6.5	Current limit values	6-17
6.6	Motor protection functions	6-18
6.7	Inherent protection	6-22

## **6.1 Various parameter sets**

The soft starter provides three individually adjustable parameter sets. One starting mode and stopping mode can be directly specified per parameter set.

### **Applications**

- Starting Dahlander motors (variable-speed drive).
- Starting an application with different load conditions (e.g. empty of full conveyor belt).
- Separate starting of up to three drives with different run-up behavior (e.g. compressor and pump).

---

## 6.2 Starting modes

Different starting functions can be selected thanks to the large number of applications for which the SIRIUS 3RW44 soft starter can be used. The motor start can be set optimally according to application and deployment.

### 6.2.1 Voltage ramp

The most simple type of soft start with the SIRIUS 3RW44 is achieved using a voltage ramp. The terminal voltage of the motor is increased from a parameterizable start voltage to line voltage within an adjustable starting time. This starting mode is preset in the quick start menu.

#### Start voltage

The height of the start voltage determines the switch-on torque of the motor. A smaller start voltage results in a smaller start torque and smaller start current. The start voltage should be selected high enough so that the motor starts immediately and softly when the start command is sent to the soft starter.

#### Starting time

The length of the starting time determines the time in which the motor voltage is increased from the set start voltage to the line voltage. This influences the acceleration torque of the motor, which drives the load during the run-up procedure. A longer starting time results in a smaller acceleration torque over the motor startup. This results in a longer and softer motor run-up. The length of the starting time should be selected such that the motor reaches its nominal speed within this time. If this time is too short, i.e. if the starting time ends before the motor has run up, an extremely high starting current will occur at that moment, reaching the value of the direct starting current at this speed. The soft starter can, in this case, switch itself off via the internal overload protection function and go into fault mode.

#### Maximum starting time

The maximum starting time parameter is used to determine the time after which the drive should have fully run up. If the drive is not in nominal operation upon completion of the set time, the starting procedure is aborted and an error message is generated.

#### Internal run-up recognition

The soft starter features an internal run-up recognition. If a completed motor run-up is recognized by the device, the internal bypass contacts will close and the thyristors are bridged. If this run-up recognition is performed before the set run-up time is completed, the ramp is aborted and the motor voltage is immediately increased to 100 % of the line voltage before the internal bypass contacts are closed.

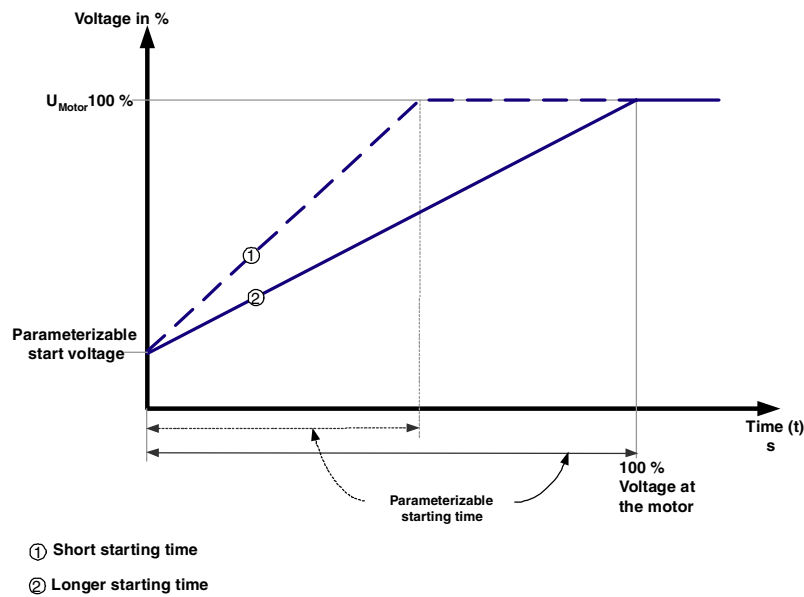

Fig. 6-1: Function principle of voltage ramp

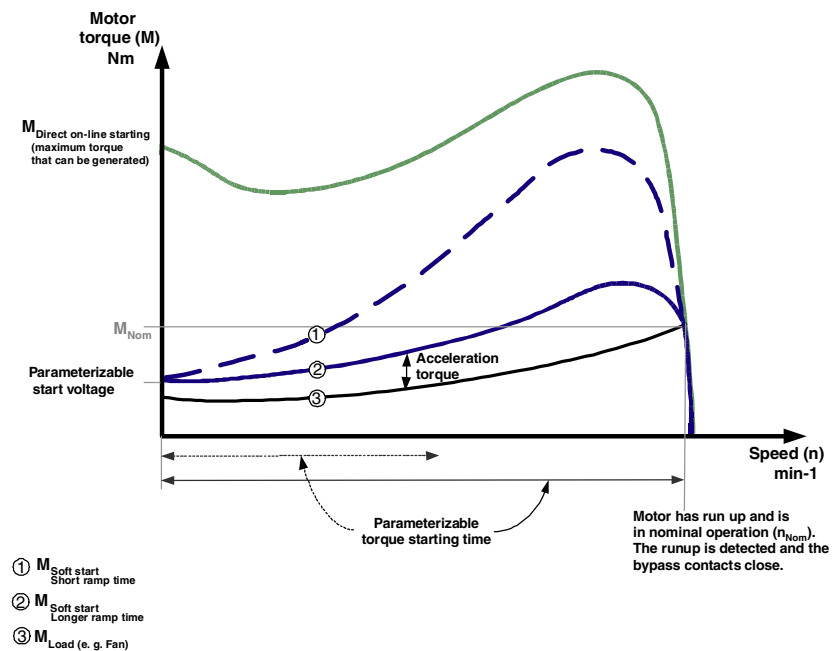

Fig. 6-2: Function principle of voltage ramp/ torque curve

### Typical applications for voltage ramps

The voltage ramp function principle is suitable for any type of application. If test runs are carried out using motors that are smaller than those used in actual applications, we recommend you use the voltage ramp starting mode. For machines requiring a breakaway pulse (inverse load response, e.g. in mills or crushers), the breakaway pulse must be set as described in Section 6.2.3. The voltage ramp+current limiting (U+current limiting) starting mode is recommended for heavy starting.

## 6.2.2 Torque control

The motor speed and torque is calculated using the voltage and current r.m.s. values as well as of the associated phase information between the line voltage and the motor current ( $= \cos \varphi =$  sensorless control) and the motor voltage is controlled accordingly.

Torque control means that the torque generated in the motor is linearly increased from a parameterizable start torque up to a parameterizable end torque within an adjustable starting time.

The advantage over the voltage ramp is improved mechanical run-up behavior of the machine.

The soft starter controls the torque generated at the motor continuously and linearly according to the set parameters until the motor has completely run up.

For optimum torque control during the starting process, the motor data of the motor connected to the soft starter should be entered in the selected parameter. This can be specified using the **Setting** menu item.

### Start torque

The height of the start torque determines the switch-on torque of the motor. A smaller start torque results in a smaller run-up torque and smaller starting current. The start torque should be selected high enough so that the motor starts immediately and softly when the start command is sent to the soft starter.

### Limiting torque

The height of the limiting torque determines which maximum torque should be generated in the motor during running up. Thus this value can also act as an adjustable torque limitation.

In order to obtain a successful run-up, the parameter value should be set to about 150 % but at least high enough so that the motor does not become stuck during startup. This ensures that enough acceleration torque is always created during the whole motor run-up.

### Starting time

The starting time length determines in what time the start torque is increased to the end torque.

A longer starting time results in a smaller acceleration torque over the motor run-up. This results in a longer and softer motor run-up. The length of the starting time should be selected such that the motor accelerates softly until it reaches its nominal speed.

If the starting time ends before the motor has completely run up, the torque is limited to the set limiting torque until the soft starter recognizes the run-up process and closes the internal bypass contacts.

### Maximum starting time

The maximum starting time parameter is used to determine after what maximum time the drive should have fully run up. If the drive is not in nominal operation upon completion of the set time, the starting procedure is aborted and an error message is generated.

### Internal run-up recognition

The soft starter features an internal run-up recognition. If a completed motor run-up is recognized within the defined starting time, the ramp will be aborted and the motor voltage will immediately be increased to 100 % of the line voltage. The internal bypass contacts will close and the thyristors are bridged.

**Notice**

The torque generated in the motor and controlled by the soft starter can at no time be higher than the value of a similar direct start at the same speed.

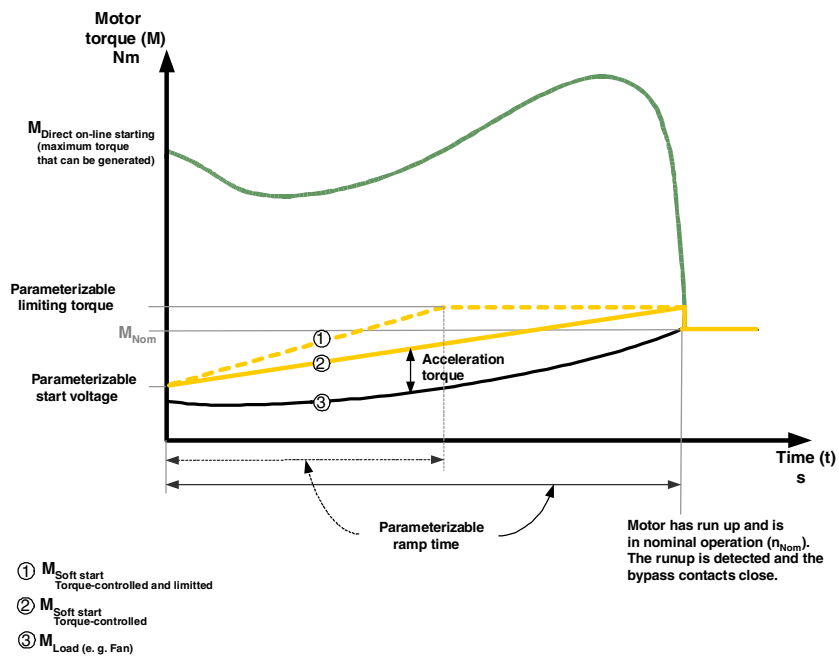

Fig. 6-3: Function principle of torque control

**Typical applications for torque control**

Suitable for all applications, especially in cases where a homogeneous and smooth run-up is required. For machines requiring a breakaway pulse (inverse load response, e.g. in mills or crushers), the breakaway pulse must be set as described in chapter 6.2.3. The torque control+current limiting (M+current limiting) starting mode is recommended for heavy starting (refer to chapter 6.2.4 Current limiting in combination with voltage ramp or torque control starting mode).

### 6.2.3 Breakaway pulse in combination with voltage ramp or torque control starting mode

This function is required for load machines with inverse torque behavior. Typical applications are mills, crushers or drives with plain bearings. Here it may be necessary to create a breakaway pulse at the beginning of the machine's start process. The breakaway pulse is set via the breakaway voltage and the breakaway time. Using the breakaway pulse, the high limiting friction of the load can be overcome and the machine can be made to move.

The breakaway pulse can be used in combination with the voltage ramp, torque control or current limiting starting modes and is superimposed on these during the whole breakaway time.

#### Breakaway voltage

The breakaway voltage is set together with the height of the breakaway torque to be created. Its maximum value can be 100 % of the start torque generated on direct starting. The pulse should be high enough for the motor to start immediately when the soft starter receives the start command.

#### Breakaway time

The breakaway time specifies how long the breakaway voltage should be applied. Upon completion of the breakaway time, the soft starter finishes its run-up process with the selected starting mode, e.g. voltage ramp or torque control. The breakaway time should be selected at least long enough so that, after the configured time has elapsed, the motor does not remain stationary again but rather accelerates further in the selected starting mode.

If 0 ms is set as breakaway time (default), the breakaway pulse function is deactivated.

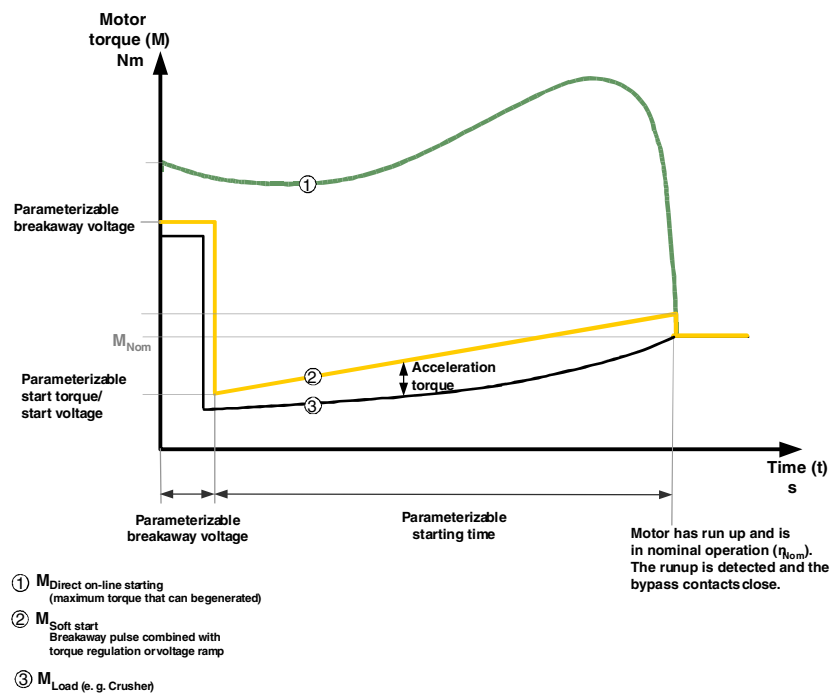

Fig. 6-4: Function principle of breakaway pulse/torque control

### **Typical applications for breakaway pulse**

Load machines with inverse torque behavior, e.g. crushers and mills.

---

#### **Notice**

A breakaway pulse that is too high may lead to the error message "current measurement range exceeded". To remedy this, use larger starter dimensions or a lower breakaway voltage.

---



## 6.2.4 Current limiting in combination with voltage ramp or torque control starting mode

The starter continuously measures the phase current (motor current) using the integrated current transformer.

During motor run-up it is possible to set a current limit value on the soft starter. The current limiting can be activated if voltage ramp+current limiting or torque control+current limiting have been selected as starting mode and a value has been entered in the relevant parameter.

During the starting procedure, the phase current is limited to the set value until it falls below this value. A defined breakaway pulse is superimposed on the current limiting during the breakaway time.

### Current limit value

As a factor of the motor rated current, the current limit value is set to the maximum current required during the starting procedure. If the set current limit value is reached, the motor voltage is lowered (or controlled) by the soft starter such that the current will not exceed the set current limit value. The configured current limit value must be selected high enough that enough torque can be created in the motor in order to bring the drive into the rated area of operation. A typical value is 3-4 times the value of the rated operating current ( $I_e$ ) of the motor.

### Run-up recognition

The soft starter features an internal run-up recognition. If a completed motor run-up is recognized, the motor voltage is immediately increased to 100 % of the line voltage. The internal bypass contacts will close and the thyristors are bridged.

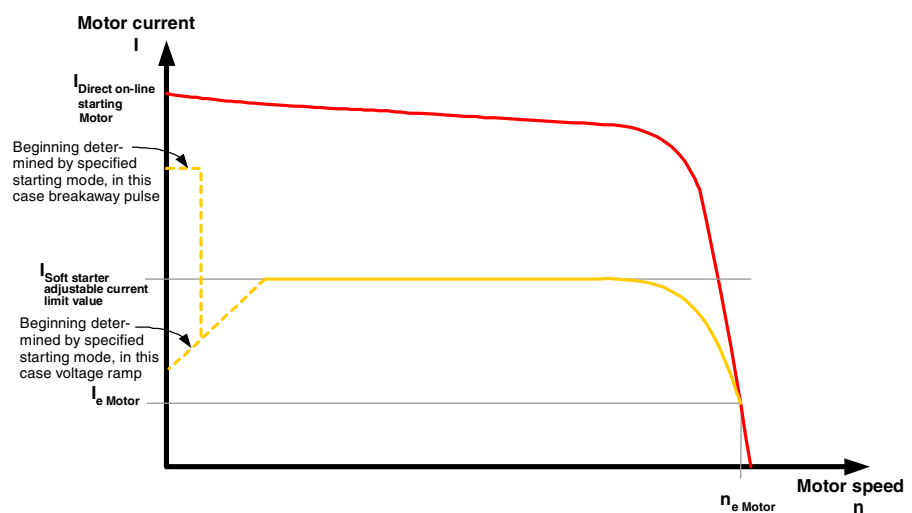

Fig. 6-5: Current limiting with soft starter

### Typical applications for current limiting

Used in applications with large centrifugal mass (mass reactance) and hence the long starting times, e.g. large fans in order to lighten the load on the supply network.

### 6.2.5 Starting mode: direct on-line

If direct on-line starting mode is set, the motor voltage is immediately increased to line voltage when it receives the start command. This resembles the starting behavior with a contactor, i.e. the starting current and start torque are not limited.

---

#### Notice

Due to the high starting current of the motor, the error "current limit exceeded" may occur in direct on-line starting mode. It may be necessary to select a larger dimensioned soft starter.

---

### Run-up recognition

The soft starter features an internal run-up recognition. If a completed motor run-up is recognized, the internal bypass contacts will close and the thyristors are bridged.

### 6.2.6 Starting mode: motor heating

If IP54 motors are used outdoors, condensation occurs in the motor during cooler periods (e.g. overnight or in winter). This may lead to leakage currents or short circuits when the units are switched on.

A pulsating DC current is fed into the motor winding to warm it up.

If the **motor heating** starting mode is selected, a heating capacity can be entered in the settings. This capacity should be chosen in such a way that the motor will not be damaged.

### Typical applications for motor heating

Used e.g. in outdoor drives to minimize condensation inside the motor.

## 6.3 Stopping modes

Different stopping functions can be selected thanks to the large numbers of applications for which the SIRIUS 3RW44 soft starter can be used. The motor stop can be set optimally according to application and deployment. If a start command is output while the motor is being stopped, this process is aborted and the motor is started up again using the specified starting mode.

### Notice

If guided stopping is selected as stopping mode (soft or pump stop or braking), it may be necessary to select a larger dimensioned branch (soft starter, wiring, branch protection elements and motor), since the current exceeds the motor rated current while the motor is being stopped.

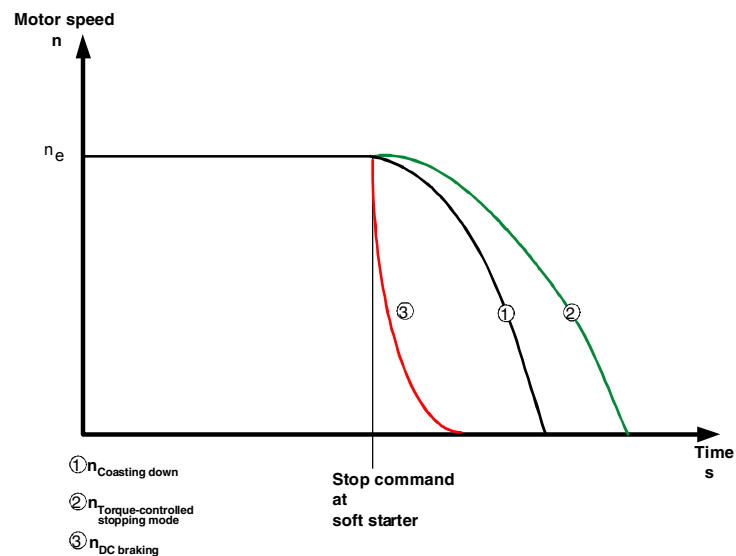

Fig. 6-6: Stopping modes in general

### 6.3.1 Coasting down

Coasting down means that when the on command on the soft starter is removed, the energy feed to the motor via the soft starter is interrupted. The motor will coast down freely, only driven by the mass reactance (centrifugal mass) of the rotor and the load. This is designated a natural run-down. A larger centrifugal mass means a longer coasting-down.

#### Typical applications for coasting down

Loads with no special requirements in terms of stopping behavior, e.g. large fans.

### 6.3.2 Torque control and pump stop

In torque-controlled and pump stop mode, the coasting down process/natural run-down of the load is extended. This function is set if abrupt stopping of the load is to be prevented. This is typical in applications with small mass reactances or high counter torques.

For optimum torque control during the stopping process, the motor data of the motor connected to the soft starter should be entered in the selected parameter. This can be specified using the Setting menu item.

#### Stopping time and stopping torque

The stopping time parameter of the soft starter, can be used to specify for how long power should be fed into the motor after removal of the switch-on command. Within this stopping time, the torque generated in the motor is continuously and linearly reduced to the set stopping torque and the application is smoothly stopped.

#### Pump stop

In pump applications, so-called water hammers may occur if the drive is stopped abruptly without using pump stop. This water hammer is caused by the sudden stall and the accompanying pressure variations in the pump. It involves noise and mechanical impact on the piping and on flaps and valves inside the system.

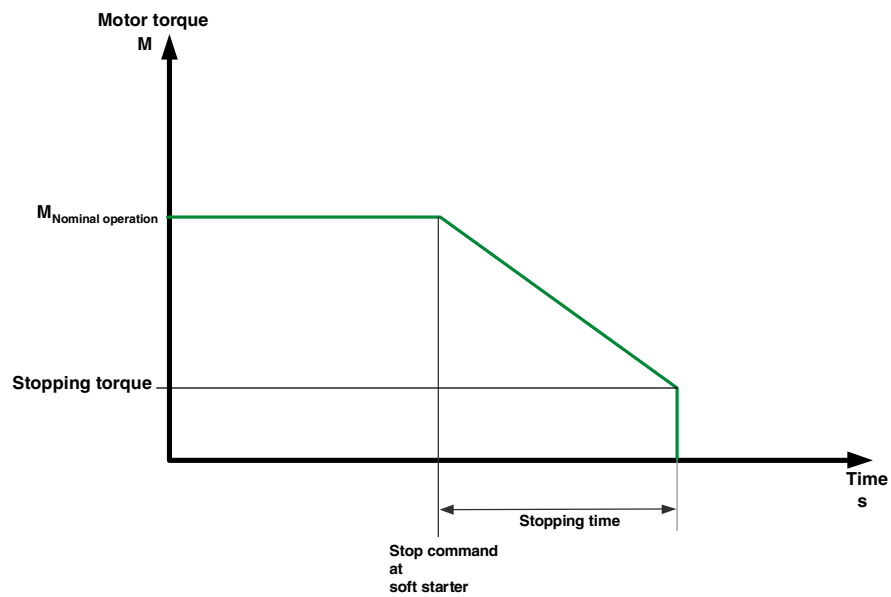

Fig. 6-7: Soft stop / pump stop

#### Typical applications for soft stop / pump stop

In pumps to prevent water hammer.

In conveyor belts to prevent goods from toppling.

---

### 6.3.3 DC braking / combined braking

In DC braking or combined braking, the coasting down / natural run-down of the load is shortened.

The soft starter imposes a (pulsating) DC current in phases L1 and L3 on the motor stator. This current creates a permanent magnetic field in the stator. Since the rotor is still rotating due to its mass reactance, currents are induced into the short rotor winding, creating a braking torque.

---

#### Notice

The pulsating DC current loads the network asymmetrically and the motor and the branch must be prepared for the higher current load during the stopping procedure. A larger dimensioned soft starter may be necessary.

---



---

#### Notice

Two braking versions are available:

#### Combined braking:

Use the combined braking function if applications with small mass reactances (centrifugal masses) are to be stopped

( $J_{load} \leq J_{motor}$ ).

#### DC braking:

Use the DC braking function if applications with larger mass reactances (centrifugal masses) are to be stopped

( $J_{load} \leq 5 \times J_{motor}$ ).

An external brake contactor is required for the DC braking function!

---

#### Stopping mode: combined braking

If combined braking is selected, the dynamic braking torque, DC braking torque and stopping time parameters can be configured at the starter.

#### Dynamic braking torque

The dynamic braking torque determines the height of the braking effect at the start of the braking process in order to reduce the rotational speed of the motor. The braking process is then continued using the DC braking torque function.

#### DC braking torque

The height of the DC braking torque determines the brake force of the motor. If the motor accelerates again during DC braking, the dynamic braking torque must be increased.

**Stopping time**

The stopping time determines how long braking torque is applied to the motor. The braking time should be long enough to bring the load to a complete standstill.

To achieve a sufficient brake effect until standstill, the centrifugal mass (J) of the load should not exceed that of the motor. The stopping time should be selected such that the motor comes to a standstill. The soft starter has no standstill recognition; if required, this must be accomplished using external measures.

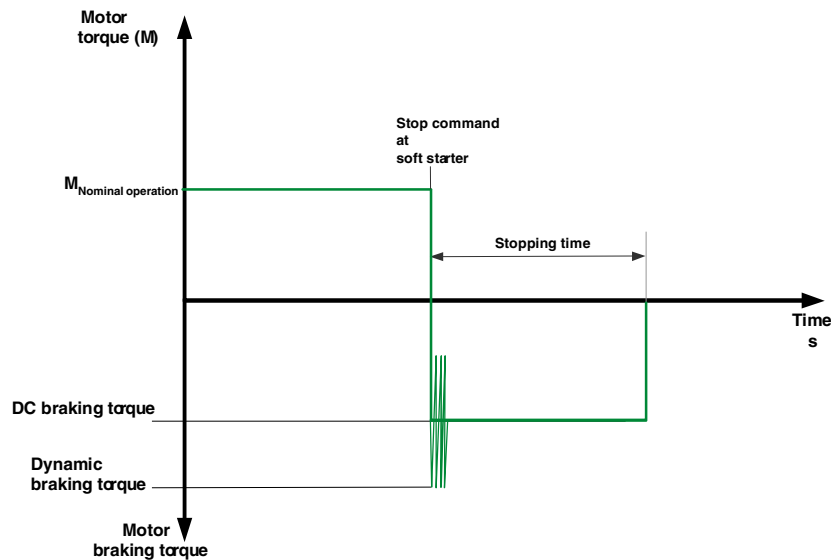

Fig. 6-8: Combined braking

**Stopping mode: DC braking**

If the DC braking function is selected, the stopping time and DC braking torque parameters can be configured on the starter. With this braking type, one output of the soft starter must be switched over to DC braking to control an external brake contactor. Please refer to Chapter 8 for wiring suggestions.

The optimum parameters must be adjusted on the machine under appropriate load conditions.

**DC braking torque**

The height of the DC braking torque determines the brake force of the motor.

**Stopping time**

The stopping time determines how long braking torque is applied to the motor. The braking time should be long enough to bring the load to a complete standstill.

To achieve a sufficient braking effect until standstill, the load's mass moment of inertia should not be higher than 5 times the motor's mass moment of inertia. ( $J_{load} \leq 5 \times J_{motor}$ ).

The soft starter has no standstill recognition; if required, this must be accomplished using external measures.

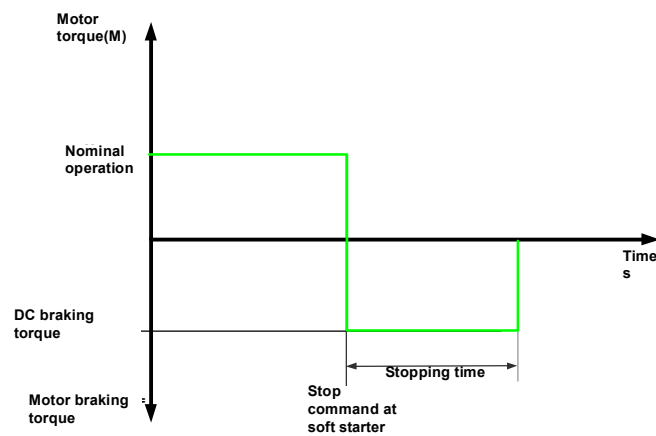

Fig. 6-9: DC braking

**Typical applications for DC braking**

Lathes (e.g. for tool changeovers) or disk saws.

## 6.4 Slow speed function

This function allows an asynchronous motor to be temporarily operated in both directions at a rotational speed that is lower than the rated rotational speed. The rated rotational speed  $n_{\text{motor}}$  of the motor is determined by its line frequency (f) and its number of pole pairs (p).

$$n_{\text{Motor}} = f \times \frac{60}{p}$$

A resulting slow speed frequency for the motor is defined by a specific thyristor control. However, this function requires that only a reduced torque can be generated in the motor. Due to possible overheating of the motor, this function is not suitable for continuous operation.

The slow speed factor and the slow torque can be entered individually for both directions of rotation.

### Slow speed factor

By adjusting the slow speed factor, it is possible to control the motor with a rotational speed ( $n_{\text{slow speed}}$ ) that is lower than the rated rotational speed either in the same or opposite direction of rotation to that of the line.

$$n_{\text{Slowspeed}} = \frac{n_{\text{Nom}}}{\text{Slowspeedfactor}}$$

### Slow torque

The torque generated in the motor can be influenced using the slow torque. The maximum torque which can be created depends on the slow torque that is specified. 100 % slow torque can correspond to approx. 30 % of the motor rated torque.

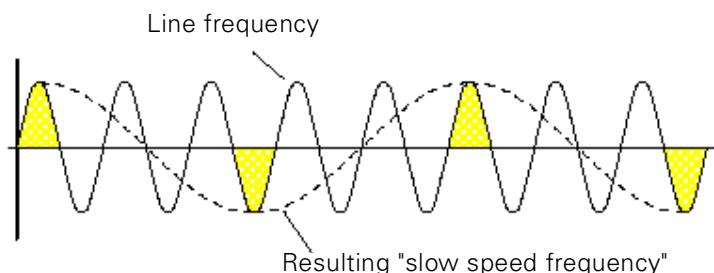

Fig. 6-10: Slow speed function

### Typical applications for slow speed function

This function is suitable for applications with a **low counter torque**, e.g. when machine tools are positioned.

#### Notice

To control the motor with the specified slow speed parameters, "slow speed" must be assigned to one control input, and "motor right PS1/2/3" or "motor left PS1/2/3" must be assigned to the other. Also refer to circuit proposal in Chapter 8.1.7.

Directions of rotation:

Right: rotation in line phase direction

Left: rotation against line phase direction



## 6.5 Current limit values

It is possible to set upper and lower current limits; if these limits are exceeded or undershot, a message can be output.

### **Lower current limit value**

The lower current limit can, for example, be used to indicate a V-belt break and the corresponding no-load current of the motor or that the fan filter is clogged.

### **Upper current limit value**

The upper limit value can be used to determine increased power loss in the application e.g. caused by storage damage.

## 6.6 Motor protection functions

The motor overload protection is based on the motor winding temperature. This temperature is used to determine whether the motor is overloaded or is operating within its normal rating.

The winding temperature can either be calculated using the integrated electronic motor overload function, or be measured using a connected motor thermistor.

Both versions must be combed (=activated) to obtain the so-called full motor protection.

### **Motor overload protection**

The current flow during motor operation is measured using current measurement at the converters in the soft starter. The temperature rise of the winding is calculated based on the configured rated operating current of the motor.

Depending on the set tripping class (class setting) and protection parameters, a warning or a trip is generated when the characteristic curve is touched.

**Tripping class  
(electronic overload  
protection)**

The tripping class (CLASS) indicates the maximum tripping time in which a protective device must trip at a value 7.2 times that of the rated operating current in cold condition (motor protection acc. to IEC 60947). The tripping characteristics indicate the tripping time in relation to the tripping current (refer to Chapter 9.4 Tripping characteristics).  
Different CLASS characteristics are available for normal or heavy starting.

**Notice**

The rated data of the soft starters are based on normal starting (CLASS 10). A larger dimension soft starter may be required for heavy starting (> CLASS 10).

**Current asymmetry  
limit value**

Three-phase asynchronous motors respond to slight line voltage asymmetries with a higher asymmetrical current consumption. This increases the temperature in the stator and rotor winding.

The asymmetric limit value is a percent value by which the motor current may deviate in the individual phases.

The reference value for the evaluation is the maximum deviation from the average value of the three phases.

Asymmetry is defined as a deviation of more than 40 % from the average value.

**Prewarning limit  
tripping reserve**

If the set prewarning time limit is reached, which is based on the calculated time until the motor is stopped by the motor protection function, a message can be output.

**Prewarning limit  
motor heat build-up**

If the configured thermal prewarning limit of the motor is reached, a message can be generated. Tripping of the motor protection occurs at 100 %.

**Idle time**

The idle time is a setpoint time for the cooling behavior of the motor model after a normal shutdown, i.e. not after overload trips.

After this period, the "thermal motor model" of the motor starter is set to 50 % if the motor heat build-up is still at > 50 %, otherwise it is set to 0 %.

This enables frequent start procedures (inching). These frequent start procedures lead to tripping where motor protection acc. to IEC 60 947 is used, depending on class setting.

The following graphic illustrates the cooling behavior with and without idle time:

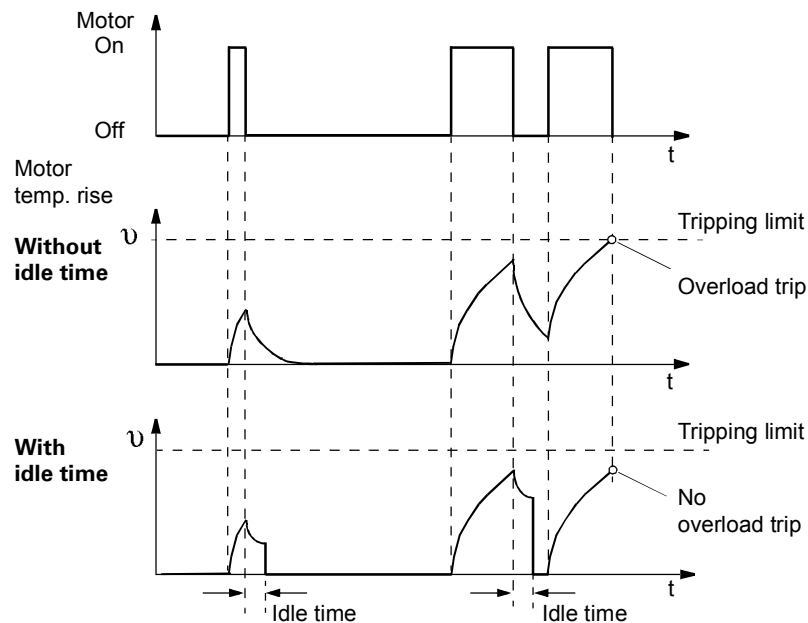

Fig. 6-11: Idle time

The idle time can be set between 1 and 100 s.



**Danger**

If the idle time is changed (0 = deactivated), motor protection acc. to IEC 60 947 (Class 10A, 10, 15, 20, 30) is no longer ensured. I.e. in such cases there will be no system protection. We recommend protection action to be taken in parallel.

**Notice**

The motor must be designed for such inching operation, otherwise the overload may cause permanent damage.

**Pre-charge time**

When the thermal motor model is tripped, a pre-charge time is started to let the motor cool down and to prevent the motor from being restarted before the pre-charge time has elapsed.

**Protection against voltage failure**

If protection against voltage failure is active and the control supply voltage breaks down while a trip is pending, the current trip condition of the thermal motor model and the current pre-charge time are stored in the soft starter. When the control supply voltage returns, the trip condition of the thermal motor model before voltage failure will be restored.

**Temperature sensor**

The temperature sensor motor protection function measures the motor's stator winding temperature directly using a measuring sensor in the motor, i.e. this requires a motor with a measuring sensor wound into the stator winding. Two different types of measuring sensors are available for the evaluation.

- PTC thermistors type A ("type A sensors")
- Thermo click

The wiring and the sensors are checked for wire breaks or short circuits.

## 6.7 Inherent protection

The soft starter has integrated device protection to prevent the thyristors becoming thermally overloaded.

This is achieved via a current measurement using converters in the three phases and by measuring the temperature with thermosensors on the thyristor heatsink.

If a fixed warning threshold is exceeded, a message to the soft starter is generated. If the fixed tripping value is exceeded, the soft starter switches off automatically.

After a trip has occurred, a fixed 30-second pre-charge time must be kept before the starter can be restarted.

If protection against voltage failure is active and the control supply voltage breaks down while a trip is pending, the current trip condition of the thermal motor model and the current pre-charge time are stored in the soft starter. When the control supply voltage returns, the trip condition of the thermal inherent protection before voltage failure will be restored.

In order to protect the thyristors from being destroyed by short circuits (e.g. in the event of cable damage or shorted coil in the motor), SITOR semiconductor fuses must be connected upstream. You can find the corresponding selection tables in Chapter 9.3.6 Branch component layout (standard circuit) and in Chapter 9.3.7 Branch component layout (inside delta circuit).

# Diagnostics and messages

# 7

Chapter	Subject	Page
7.1	Diagnostics, messages	7-2
7.1.1	Status messages	7-2
7.1.2	Warnings and group errors	7-2
7.1.3	Device errors	7-4

## 7.1 Diagnostics, messages

### 7.1.1 Status messages

Message	Cause / Remedy
Check voltage	Main voltage not yet applied.
Check mains phases	Main voltage is applied, but the motor is not connected or not properly connected, or the motor is properly connected but no phase voltage is present.
Ready to start	Device is ready to start (main voltage is applied and the motor is connected properly). The motor will start when a start command is received.
Starting is active	Motor is started in the set starting mode.
Motor is running	Device is in bridging mode (bypass contactor). Starting completed.
Stopping is active	Motor is stopped using the selected stopping mode.
Motor cool-down time active	After overload tripping of the thermal motor model, it is impossible to start the motor for a defined period of time (parameter: pre-charge time) to ensure that the motor can cool down.
Contact block cool-down time	After overload tripping of the inherent protection, motor start is impossible for 30 s to allow the device to cool down.

### 7.1.2 Warnings and group errors

Message	Warning	Error without restart	Error with restart	Cause / Remedy
No line voltage		x		Start command output even though the main voltage has not yet been applied. Remedy: switch on line voltage.
Wrong start conditions		x		Motor not properly connected, or faults have occurred during starting (e.g. external interference or earth fault during run-up). Remedy: check circuitry (e.g. if inside delta circuit is wired according to example circuit) or remove interferences.
Phase failure L1		x		Phase L1 missing or it fails while motor is running or it drops off. Remedy: connect L1 or remove cause of voltage drop. Or: the motor that is connected is too small and the error message occurs immediately after switching over to bridging mode. Remedy: adjust rated operating current for connected motor or set it to minimum (if motor current is lower than 10 % of the configured $I_g$ , the motor cannot be operated with this starter).
Phase failure L2		x		Phase L2 missing or it fails while motor is running or it drops off. Remedy: connect L2 or remove cause of voltage drop.
Phase failure L3		x		Phase L3 missing or it fails while motor is running or it drops off. Remedy: connect L3 or remove cause of voltage drop.
Missing load phase T1		x		Motor phase T1 is not connected. Remedy: connect motor properly.
Missing load phase T2		x		Motor phase T2 is not connected. Remedy: connect motor properly.
Missing load phase T3		x		Motor phase T3 is not connected. Remedy: connect motor properly.



Message	Warning	Error without restart	Error with restart	Cause / Remedy
Supply voltage under 75%		x		Control supply voltage is below 75 % of the required nominal voltage for longer than 100 ms (voltage failure, voltage drop, wrong control supply voltage). Remedy: check control supply voltage.
Supply voltage under 85%		x		Control supply voltage is below 85 % of the required nominal voltage for longer than 2 ms (voltage failure, voltage drop). Remedy: check control supply voltage.
Supply voltage over 110%		x		Control supply voltage is below 110 % of the required nominal voltage for longer than 100 ms (voltage peaks, wrong control supply voltage). Remedy: check control supply voltage.
Current asymmetry exceeded	x	x		Phase currents are asymmetric (asymmetric load). Message is output when the asymmetry is greater than the configured limit (parameter: current asymmetry limit value). Remedy: check load or change parameter value.
Thermal motor model overload	x	x	x	The thermal motor model has tripped. After an overload trip, there will be no restart until the pre-charge time has elapsed.  Remedy for unwanted tripping: - check whether the motor rated operating current $I_e$ is not adjusted properly or - change CLASS setting or - reduce switching frequency or - deactivate motor protection (CLASS OFF)
Prewarning limit motor heat build-up	x			Motor heat build-up is greater than the specified value for the "prewarning limit motor heat build-up" parameter. The thermal motor model approaches an overload trip according to the selected value.
Remaining time for tripping undershot	x			Time for overload tripping of the thermal motor model is shorter than the specified value for the "prewarning limit remaining time for tripping" parameter.
Line overvoltage		x		Applied main voltage is not suitable for the device or longer voltage peaks occur. Remedy: apply correct voltage.
Current measuring range exceeded		x		A very high current has occurred (beyond the measuring range of the current transformers integrated in the soft starter). This may happen in the case of: direct on-line starting, breakaway pulse or combined braking. Remedy: If voltage ramp starting mode is selected, extend the set ramp time or lower the breakaway voltage or the braking torque. The soft starter dimension is possibly too small for the motor.
Switch off - motor stalls		x		A very high current suddenly occurs in bridging mode, e.g. when the motor stalls. Remedy: check motor.
Current range exceeded		x		A current of more than 6 times the rated operating current has occurred for a long period of time. Remedy: activate current limiting or check dimensioning (device/motor).
Power component overheated		x	x	Overload trip of the thermal model for the power component. Remedy: wait until the device has cooled down, try to set a lower current limit or reduce the switching frequency (too many starts in succession).
Power component overtemperature	x			Temperature of the thermal model for the power component is higher than the permissible permanent operating temperature.
Temperature sensor short circuit	x	x	x	Temperature sensor is short at terminals T1/T2. Remedy: check temperature sensor.
Temperature sensor wire break	x	x	x	Temperature sensor at terminals T1/T2 is defective or a cable is not connected or no sensor is connected at all. Remedy: check temperature sensor, or if none is connected: deactivate temperature sensor.
Temperature sensor overload	x	x	x	Temperature sensor at terminals T1/T2 has tripped, the motor is overheated. Remedy: wait until the motor has cooled down.

## Diagnostics and messages

Message	Warning	Error without restart	Error with restart	Cause / Remedy
Max. starting time exceeded		x		The selected starting time is shorter than the run-up time of the motor. Remedy: extend starting time or increase current limit.
le limit overshoot/undershot	x	x		Set current limit has been exceeded or undershot, e.g. by a clogged fan filter or by the motor stalling. Remedy: check motor for cause of current limit violation.
Earth fault recognized	x	x		One phase is connected to earth (only possible in bypass operation). Remedy: check connections and wiring.
Connection break manually, locally	x			Connection to the PC broken (if PC-controlled) or no key has been pressed for a long period of time (> activity monitoring time) (if motor is key-controlled). The control will be handed over to the inputs if they requested the control priority. Remedy: reconnect PC or increase activity monitoring time and press a key at regular intervals.

### 7.1.3 Device errors

Message	Cause / Remedy
Contact block 1 failed	Thyristor in phase L1 has become short-circuited.
Contact block 2 failed	Thyristor in phase L2 has become short-circuited.
Contact block 3 failed	Thyristor in phase L3 has become short-circuited.
Flash memory faulty	The device memory is faulty.
Device not named	Device has not yet been named, must receive naming data. Please contact our Technical Assistance.
Wrong naming version	The naming and firmware versions do not match. Please contact our Technical Assistance.
Bypass element defective	The bypass contactor is welded or defective.
Heatsink sensor wire break	The temperature sensor at the heatsink of the starter is not connected or is defective.
Heatsink sensor short circuit	The temperature sensor at the heatsink of the starter is defective.

#### Notice

It may occur that wrong error messages are output (e.g. phase failure L1, even though it is actually L2 that is missing).

## Circuit examples

# 8

<b>Chapter</b>	<b>Subject</b>	<b>Page</b>
8.1	Connection examples for main and control circuits	8-2
8.1.1	3RW44 in a standard circuit with control via keys	8-2
8.1.2	3RW44 in a standard circuit with line contactor and control via PLC	8-3
8.1.3	3RW44 in standard circuit and DC braking stopping function for device types 3RW44 22 to 3RW44 25	8-4
8.1.4	3RW44 in standard circuit and DC braking stopping function for device types 3RW44 26 to 3RW44 47	8-5
8.1.5	3RW44 in an inside delta circuit	8-6
8.1.6	3RW44 in a standard circuit and controlled like a contactor	8-7
8.1.7	3RW44 in a standard circuit with soft start/stop and additional slow speed function in both directions of rotation with one parameter set	8-8
8.1.8	3RW 44 in a standard circuit with reversing operation via main contactors with one parameter set	8-9

## 8.1 Connection examples for main and control circuits

### 8.1.1 3RW44 in a standard circuit with control via keys

#### Main circuit

Option 1a:  
Standard circuit with circuit breaker and SITOR fuse  
(pure semiconductor protection)

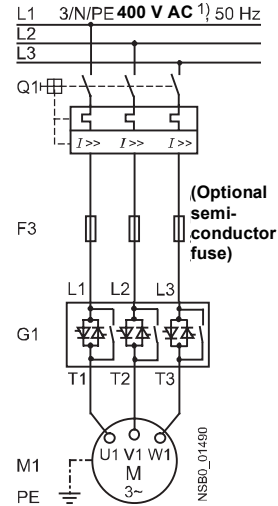

#### Control circuit

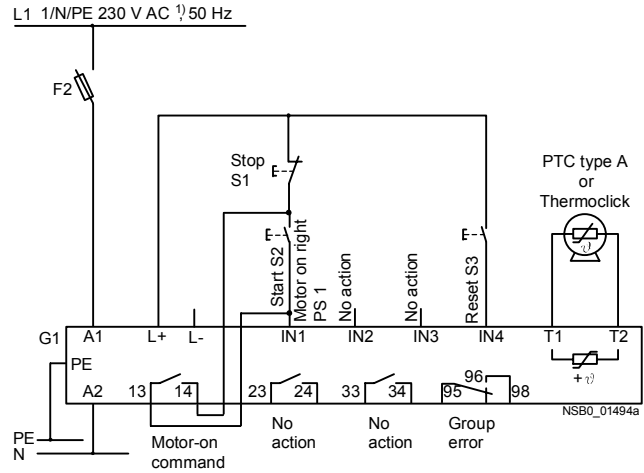

### Alternative branch layout in standard circuit

#### Main circuit

Option 1b:  
Standard circuit with general-purpose fuse  
(line and semiconductor protection)

Option 1c:  
Standard circuit with line and SITOR fuse  
(pure semiconductor protection)

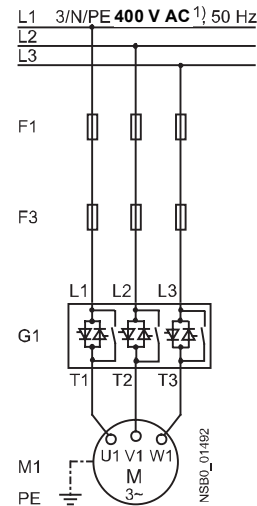
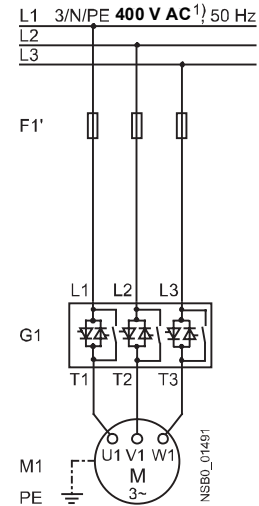

1) For permissible main and control voltage values, refer to Technical Data, pages 9-7 to 9-10.

### 8.1.2 3RW44 in a standard circuit with line contactor and control via PLC

Main circuit

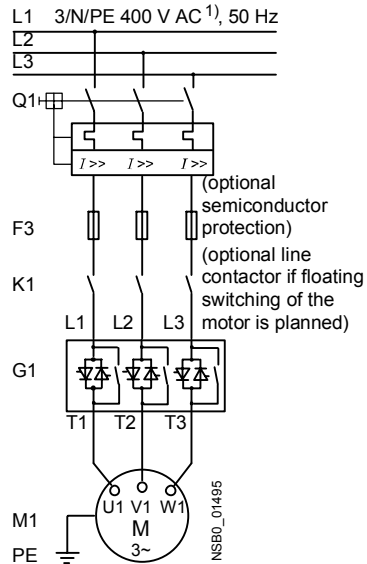

Control circuit

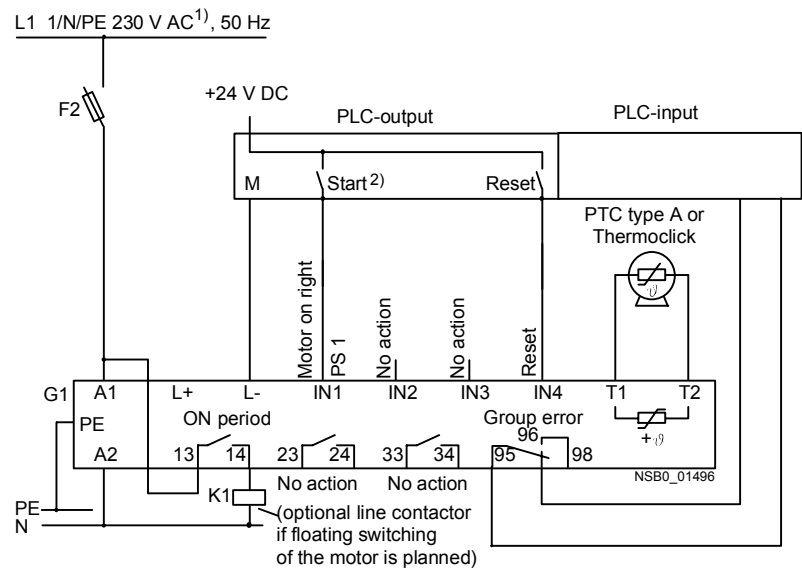

1) For permissible main and control voltage values, refer to Technical Data, pages 9-7 to 9-10.

#### 2) Caution: risk of restart!

The start command (e.g. by the PLC) must be reset before a reset command, since an automatic restart is executed when a start command is pending after the reset command. This especially applies to motor protection tripping.

For safety reasons it is recommended to integrate the group fault output (terminals 95 and 96) into the control.

## Circuit examples

### 8.1.3 3RW44 in a standard circuit with DC braking<sup>3)</sup> stopping function for device types 3RW44 22 to 3RW44 25

Main circuit

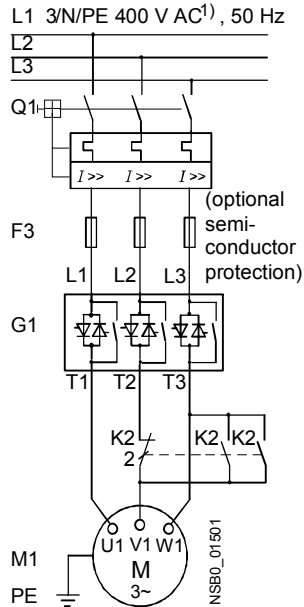

Control circuit

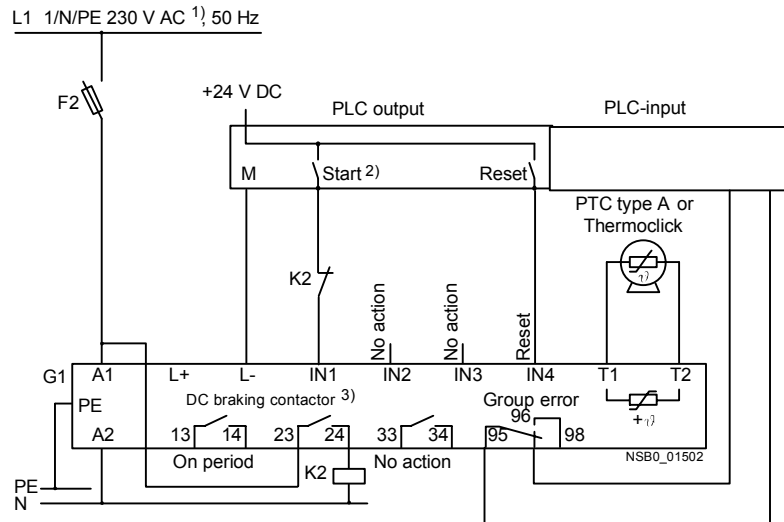

1) For permissible main and control voltage values, refer to Technical Data, pages 9-7 to 9-10.

#### 2) Caution: risk of restart!

The start command (e.g. by the PLC) must be reset before a reset command, since an automatic restart is executed when a start command is pending after the reset command. This especially applies to motor protection tripping. For safety reasons it is recommended to integrate the group fault output (terminals 95 and 96) into the control.

3) If the "combined braking" stopping function is selected, no brake contactor is necessary.  
If the "DC braking" stopping function is selected, a brake contactor must be additionally used. Refer to the "branch component layout (standard circuit)" table on page 9-15 for types.  
The "DC braking" function is recommended for applications with larger centrifugal masses ( $J_{load} > J_{motor}$ ).  
Output 2 must be switched over to "DC brake contactor".

### 8.1.4 3RW44 in a standard circuit with DC braking<sup>3)</sup> stopping function for device types 3RW44 26 to 3RW44 47

Main circuit

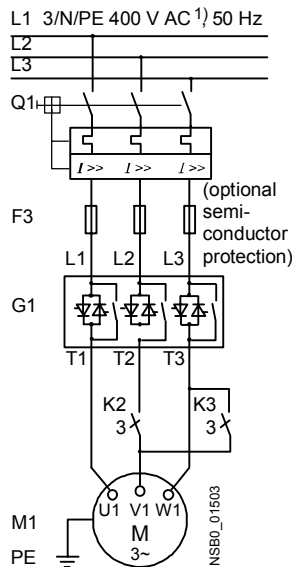

Control circuit

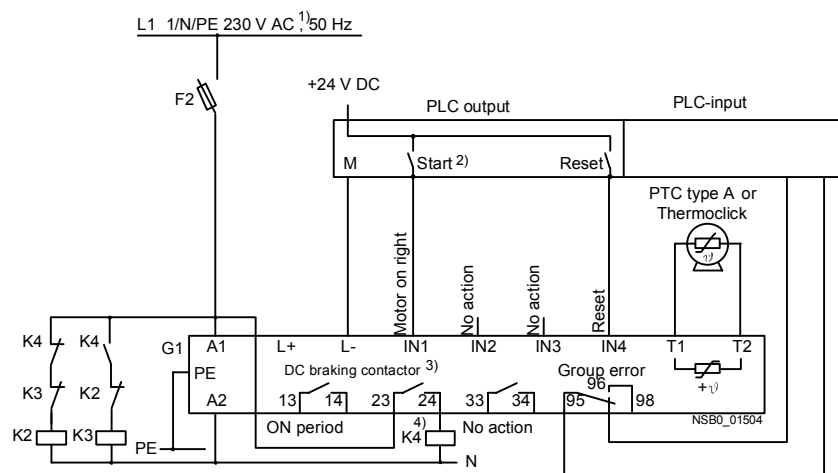

1) For permissible main and control voltage values, refer to Technical Data, pages 9-7 to 9-10.

#### 2) Caution: risk of restart!

The start command (e.g. by the PLC) must be reset before a reset command, since an automatic restart is executed when a start command is pending after the reset command. This especially applies to motor protection tripping. For safety reasons it is recommended to integrate the group fault output (terminals 95 and 96) into the control.

- 3) If the "combined braking" stopping function is selected, no brake contactor is necessary.  
If the "DC braking" stopping function is selected, a brake contactor must be additionally used. Refer to "branch component layout (standard circuit)" table on page 9-15 for types.  
The "DC braking" function is recommended for applications with larger centrifugal masses ( $J_{load} > J_{motor}$ ).  
Output 2 must be switched over to "DC brake contactor".
- 4) K4 auxiliary relay, e.g.:  
LZX:RT4A4T30 (230 V AC rated control supply voltage),  
LZX:RT4A4S15 (115 V AC rated control supply voltage).

### 8.1.5 3RW44 in an inside delta circuit

**Main circuit**

Option 1a:

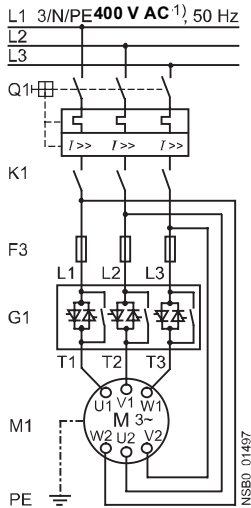

**Control circuit**

Option 1:

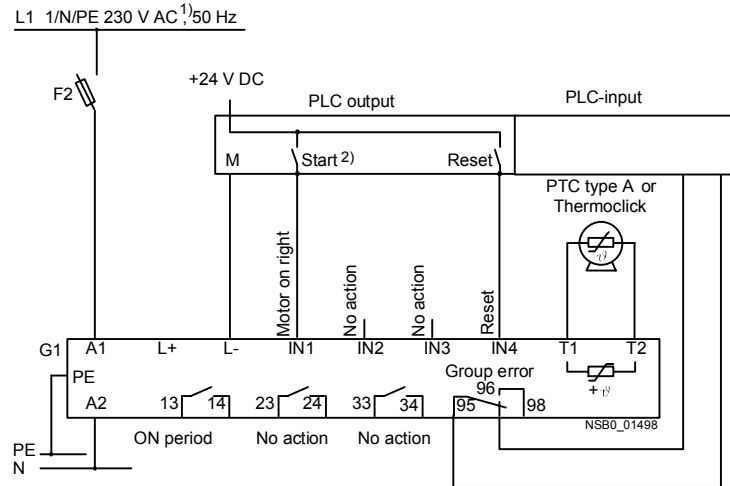

### Reversed direction of rotation in an inside delta circuit

**Main circuit**

Option 1b:

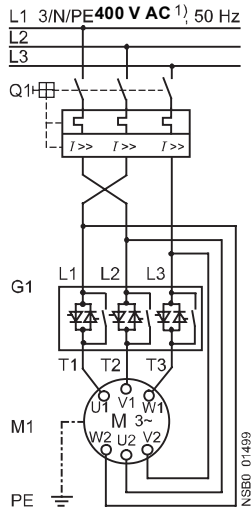

**Caution**

Observe the wiring suggestions for the inside delta circuit on the main circuit page. Faulty connection may lead to disturbances.

1) For permissible main and control voltage values, refer to Technical Data, pages 9-7 to 9-10.

**Caution: risk of restart!**

The start command (e.g. by the PLC) must be reset before a reset command, since an automatic restart is executed when a start command is pending after the reset command. This especially applies to motor protection tripping.

For safety reasons it is recommended to integrate the group fault output (terminals 95 and 96) into the control.



8.1.6 3RW44 in a standard circuit and controlled like a contactor

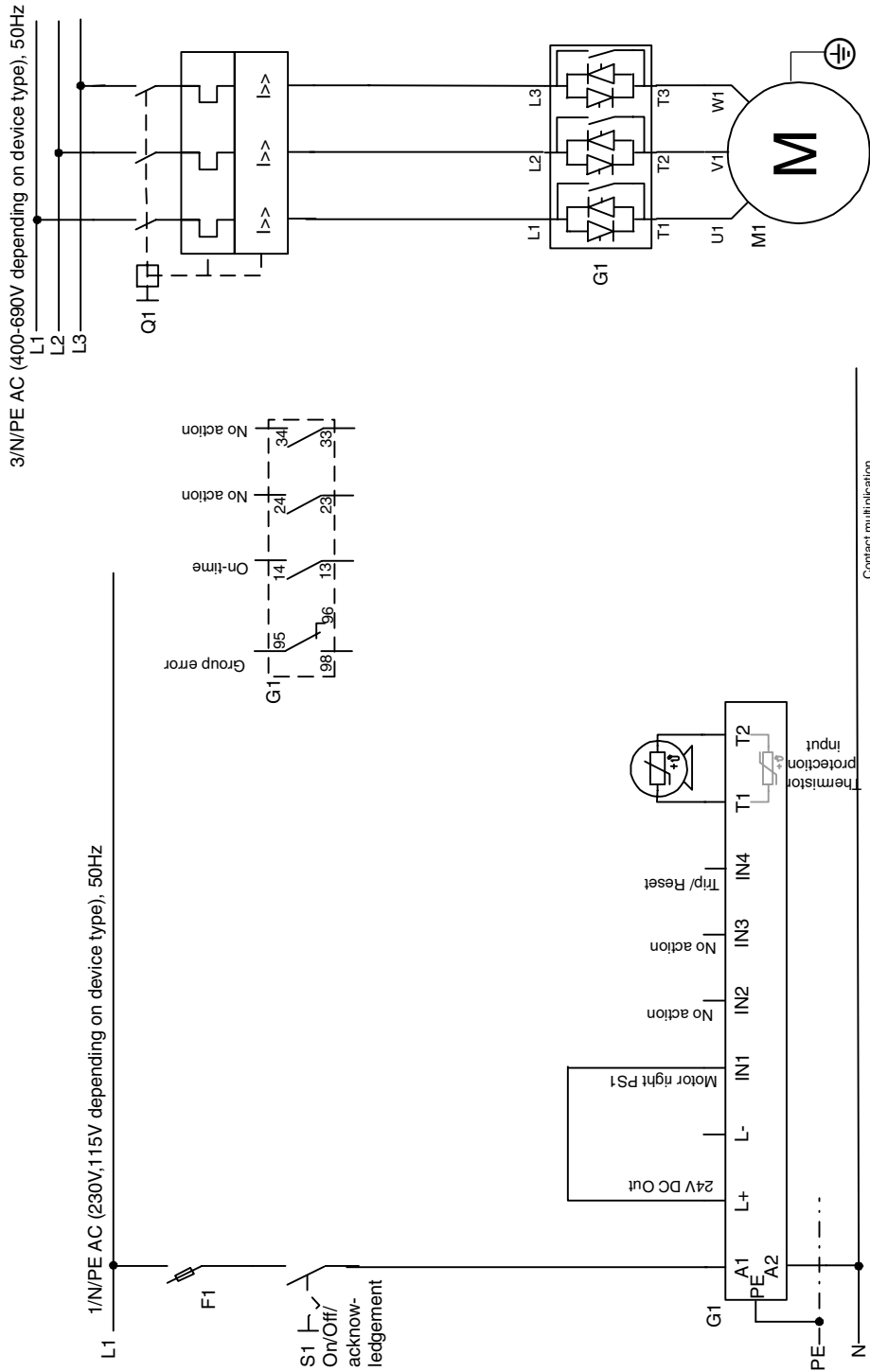

**Notice**

In this circuit type, the motor start may be delayed by up to 5 s in relation to the start command due to the internal run times of the soft starter. Coasting down is the only possible starting mode.

**Caution**

After switching off the control supply voltage and before restarting, the device must be allowed to cool down for at least 30 s, because this has an influence on the effectiveness of the inherent protection of the soft starter.

This circuit type is not recommended for higher switching frequencies, since the integrated fan cannot idle after the soft starter has been switched off meaning the switching frequency specified in the technical data will be reduced.

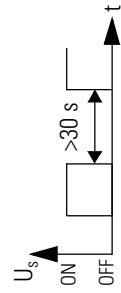

**8.1.7 3RW44 in a standard circuit with soft start/stop and additional slow speed function in both directions of rotation with one parameter set**

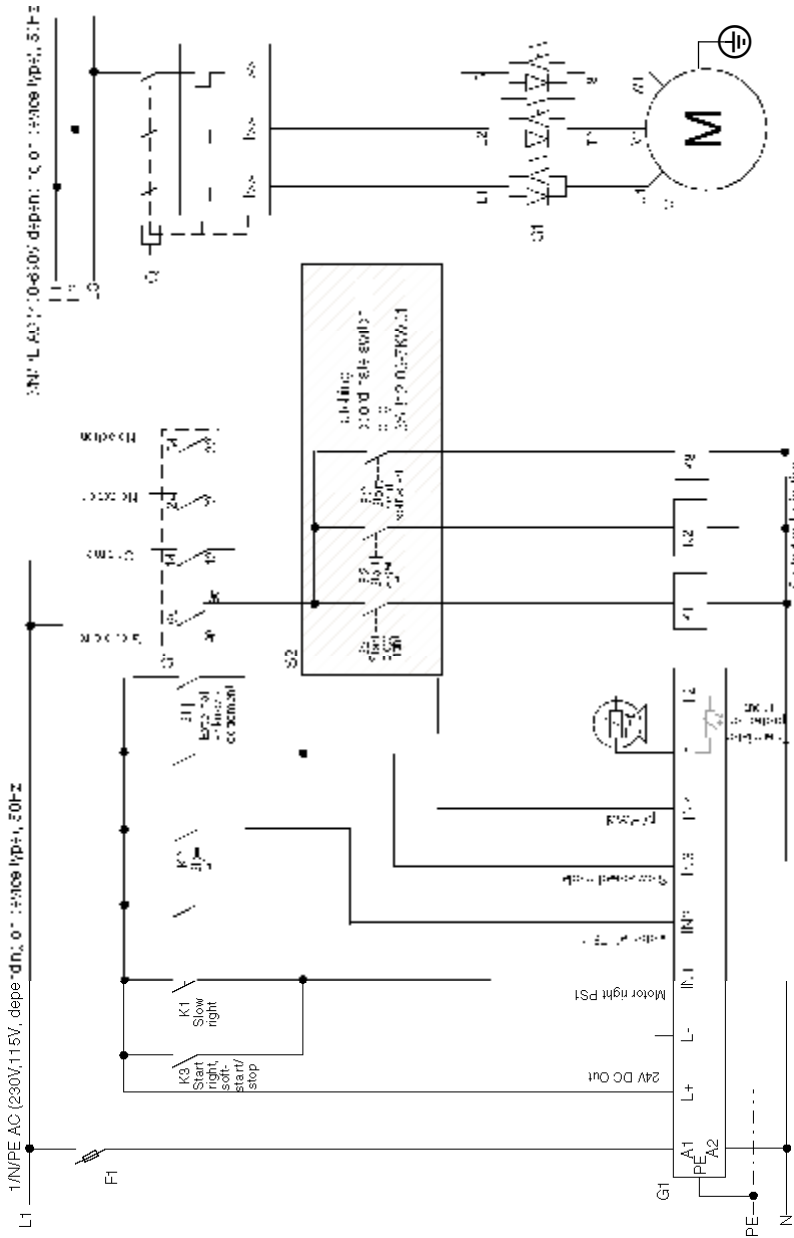

**Notice: parameterization**

Set the control input functions to:

IN1: Motor right PS1

IN2: Motor left PS1

IN3: Slow speed mode

IN4: Trip / reset (factory setting)

The slow speed parameters in parameter set 1 must be set. Motor right means rotation in line phase direction, motor left means rotation against line phase direction.

**Caution**

The slow speed function is not suitable for continuous operation. The motor can overheat at slow speed during continuous operation.

**Caution: risk of restart:**

The start command must be reset before a reset command, since an automatic restart is executed when a start command is pending after the reset command. This especially applies to motor protection tripping.

K1, K2, K3 = relays for contact multiplication. e.g. for 230 V AC operation: 3RS 1800-1BP00

8.1.8 3RW 44 in a standard circuit with reversing operation via main contactors with one parameter set

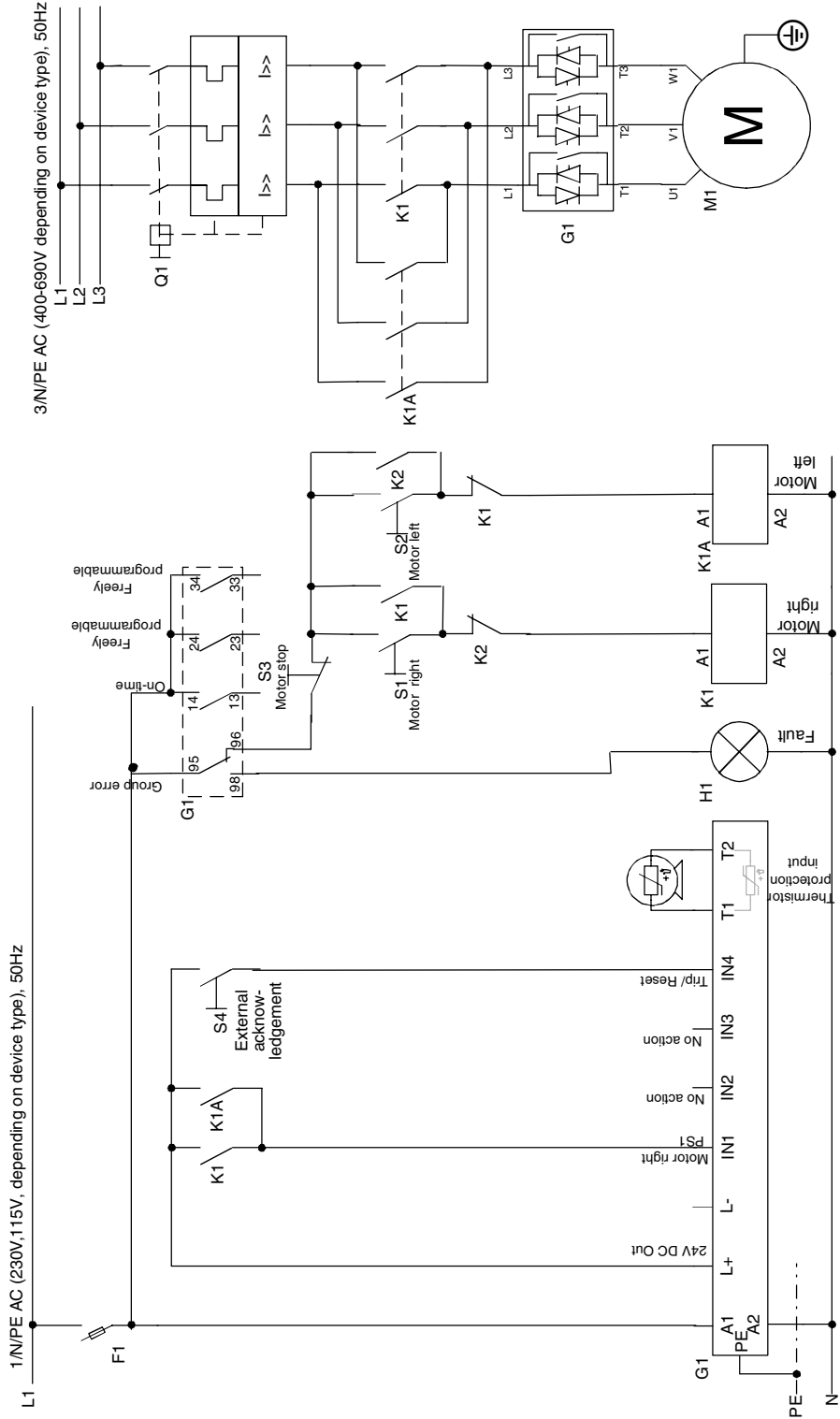



## General technical data

# 9

<b>Chapter</b>	<b>Subject</b>	<b>Page</b>
9.1	Menu structure	9-2
9.2	Transport and storage conditions	9-4
9.3	Technical data	9-5
9.3.1	Selection and ordering data	9-5
9.3.2	Technical data power component	9-7
9.3.3	Technical data control section	9-10
9.3.4	Conductor cross-sections	9-13
9.3.5	Electromagnetic compatibility	9-14
9.3.6	Branch component layout (standard circuit)	9-15
9.3.7	Branch component layout (inside delta circuit)	9-16
9.3.8	Accessories	9-17
9.4	Tripping characteristics	9-18
9.4.1	Motor protection tripping characteristics: 3RW44 with symmetry	9-18
9.4.2	Motor protection tripping characteristics: 3RW44 with asymmetry	9-18
9.5	Dimension drawings	9-19

## 9.1 Menu structure

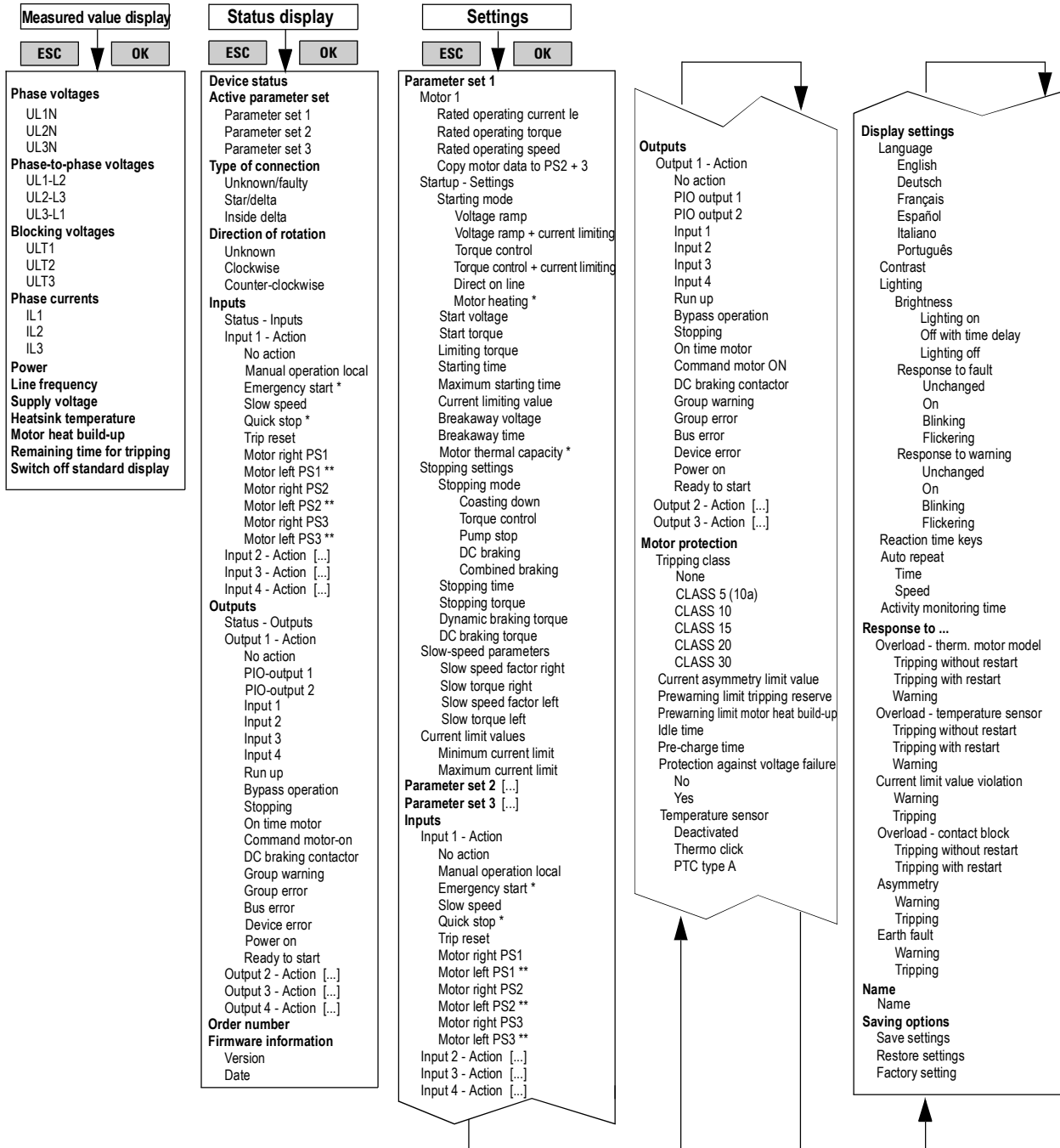

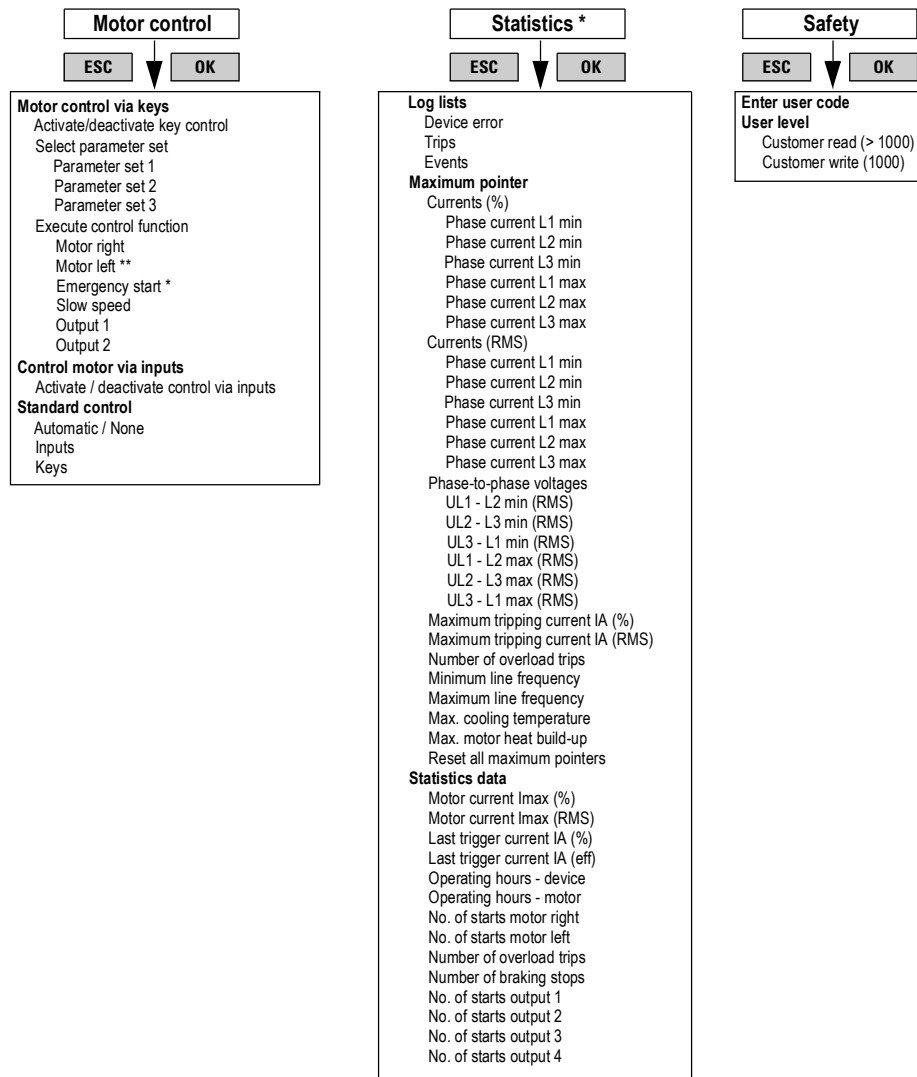

\* Delivery version 2

\*\* Possible only in connection with slow speed

## 9.2 Transport and storage conditions

### Transport and storage conditions

The soft starters comply with the requirements of DIN IEC 721-3-1/HD478.3.1 P1 for transport and storage conditions. The following data applies to modules which are transported and stored in their original packing.

Type of condition	Permissible range
Temperature	from -40 °C to +80 °C
Atmospheric pressure	from 700 to 1060 hPa (normal operation up to 1000 m, 3000 m with derating)
Relative humidity	from 10 to 95 %



### 9.3 Technical data

#### 9.3.1 Selection and ordering data

		Standard circuit					Standard circuit					
		Ambient temperature 40 °C					Ambient temperature 50 °C					
Rated operating voltage $U_e$	Rated operating current $I_e$	Rated output of three-phase induction motors for rated operating voltage $U_e$					Rated operating current $I_e$	Rated output of three-phase induction motors for rated operating voltage $U_e$				Order No.
		230 V kW	400 V kW	500 V kW	690 V kW	1000 V kW		200 V HP	230 V HP	460 V HP	575 V HP	
V	A											
200 ... 460	29	5.5	15	—	—	—	26	7.5	7.5	15	—	3RW44 22-□BC□4
	36	7.5	18.5	—	—	—	32	10	10	20	—	3RW44 23-□BC□4
	47	11	22	—	—	—	42	10	15	25	—	3RW44 24-□BC□4
	57	15	30	—	—	—	51	15	15	30	—	3RW44 25-□BC□4
	77	18.5	37	—	—	—	68	20	20	50	—	3RW44 26-□BC□4
	93	22	45	—	—	—	82	25	25	60	—	3RW44 27-□BC□4
400 ... 600	29	—	15	18.5	—	—	26	—	—	15	20	3RW44 22-□BC□5
	36	—	18.5	22	—	—	32	—	—	20	25	3RW44 23-□BC□5
	47	—	22	30	—	—	42	—	—	25	30	3RW44 24-□BC□5
	57	—	30	37	—	—	51	—	—	30	40	3RW44 25-□BC□5
	77	—	37	45	—	—	68	—	—	50	50	3RW44 26-□BC□5
	93	—	45	55	—	—	82	—	—	60	75	3RW44 27-□BC□5
400 ... 690	29	—	15	18.5	30	—	26	—	—	15	20	3RW44 22-□BC□6
	36	—	18.5	22	37	—	32	—	—	20	25	3RW44 23-□BC□6
	47	—	22	30	45	—	42	—	—	25	30	3RW44 24-□BC□6
	57	—	30	37	55	—	51	—	—	30	40	3RW44 25-□BC□6
	77	—	37	45	75	—	68	—	—	50	50	3RW44 26-□BC□6
	93	—	45	55	90	—	82	—	—	60	75	3RW44 27-□BC□6
<b>Order No. extension for connection method</b>											Screw-type terminals	↑ 1
											Spring-loaded terminals	↑ 3
200 ... 460	113	30	55	—	—	—	100	30	30	75	—	3RW44 34-□BC□4
	134	37	75	—	—	—	117	30	40	75	—	3RW44 35-□BC□4
	162	45	90	—	—	—	145	40	50	100	—	3RW44 36-□BC□4
	203	55	110	—	—	—	180	50	60	125	—	3RW44 43-□BC□4
	250	75	132	—	—	—	215	60	75	150	—	3RW44 44-□BC□4
	313	90	160	—	—	—	280	75	100	200	—	3RW44 45-□BC□4
	356	110	200	—	—	—	315	100	125	250	—	3RW44 46-□BC□4
	432	132	250	—	—	—	385	125	150	300	—	3RW44 47-□BC□4
400 ... 600	113	—	55	75	—	—	100	—	—	75	75	3RW44 34-□BC□5
	134	—	75	90	—	—	117	—	—	75	100	3RW44 35-□BC□5
	162	—	90	110	—	—	145	—	—	100	125	3RW44 36-□BC□5
	203	—	110	132	—	—	180	—	—	125	150	3RW44 43-□BC□5
	250	—	132	160	—	—	215	—	—	150	200	3RW44 44-□BC□5
	313	—	160	200	—	—	280	—	—	200	250	3RW44 45-□BC□5
	356	—	200	250	—	—	315	—	—	250	300	3RW44 46-□BC□5
	432	—	250	315	—	—	385	—	—	300	400	3RW44 47-□BC□5
400 ... 690	113	—	55	75	110	—	100	—	—	75	75	3RW44 34-□BC□6
	134	—	75	90	132	—	117	—	—	75	100	3RW44 35-□BC□6
	162	—	90	110	160	—	145	—	—	100	125	3RW44 36-□BC□6
	203	—	110	132	200	—	180	—	—	125	150	3RW44 43-□BC□6
	250	—	132	160	250	—	215	—	—	150	200	3RW44 44-□BC□6
	313	—	160	200	315	—	280	—	—	200	250	3RW44 45-□BC□6
	356	—	200	250	355	—	315	—	—	250	300	3RW44 46-□BC□6
	432	—	250	315	400	—	385	—	—	300	400	3RW44 47-□BC□6
<b>Order No. extension for connection method</b>											Spring-loaded terminals	↑ 2
<b>Order No. extension for rated control supply voltage <math>U_s</math></b>											Screw-type terminals	↑ 6
											115 V AC	3
											230 V AC	4

General technical data

Rated operating voltage $U_e$	Inside delta circuit				Inside delta circuit				Order No.
	Ambient temperature 40 °C				Ambient temperature 50 °C				
	Rated operating current $I_e$	Rated output of three-phase induction motors for rated operating voltage $U_e$			Rated operating current $I_e$	Rated output of three-phase induction motors for rated operating voltage $U_e$			
V	A	230 V kW	400 V kW	500 V kW	A	200 V HP	230 V HP	460 V HP	
200 ... 400	50	15	22	—	45	10	15	—	3RW44 22-□BC□4
	62	18.5	30	—	55	15	20	—	3RW44 23-□BC□4
	81	22	45	—	73	20	25	—	3RW44 24-□BC□4
	99	30	55	—	88	25	30	—	3RW44 25-□BC□4
	133	37	75	—	118	30	40	—	3RW44 26-□BC□4
	161	45	90	—	142	40	50	—	3RW44 27-□BC□4
400 ... 600	50	—	22	30	45	—	—	30	3RW44 22-□BC□5
	62	—	30	37	55	—	—	40	3RW44 23-□BC□5
	81	—	45	45	73	—	—	50	3RW44 24-□BC□5
	99	—	55	55	88	—	—	60	3RW44 25-□BC□5
	133	—	75	90	118	—	—	75	3RW44 26-□BC□5
	161	—	90	110	142	—	—	100	3RW44 27-□BC□5
400 ... 690	50	—	22	30	45	—	—	30	3RW44 22-□BC□6
	62	—	30	37	55	—	—	40	3RW44 23-□BC□6
	81	—	45	45	73	—	—	50	3RW44 24-□BC□6
	99	—	55	55	88	—	—	60	3RW44 25-□BC□6
	133	—	75	90	118	—	—	75	3RW44 26-□BC□6
	161	—	90	110	142	—	—	100	3RW44 27-□BC□6
	<b>Order No. extension for connection method</b>							Screw-type terminals Spring-loaded terminals	↑ 1 ↑ 3
200 ... 400	196	55	110	—	173	50	60	—	3RW44 34-□BC□4
	232	75	132	—	203	60	75	—	3RW44 35-□BC□4
	281	90	160	—	251	75	100	—	3RW44 36-□BC□4
	352	110	200	—	312	100	125	—	3RW44 43-□BC□4
	433	132	250	—	372	125	150	—	3RW44 44-□BC□4
	542	160	315	—	485	150	200	—	3RW44 45-□BC□4
	617	200	355	—	546	150	200	—	3RW44 46-□BC□4
	748	250	400	—	667	200	250	—	3RW44 47-□BC□4
400 ... 600	196	—	110	132	173	—	—	125	3RW44 34-□BC□5
	232	—	132	160	203	—	—	150	3RW44 35-□BC□5
	281	—	160	200	251	—	—	200	3RW44 36-□BC□5
	352	—	200	250	312	—	—	250	3RW44 43-□BC□5
	433	—	250	315	372	—	—	300	3RW44 44-□BC□5
	542	—	315	355	485	—	—	400	3RW44 45-□BC□5
	617	—	355	450	546	—	—	450	3RW44 46-□BC□5
	748	—	400	500	667	—	—	600	3RW44 47-□BC□5
400 ... 690	196	—	110	132	173	—	—	125	3RW44 34-□BC□6
	232	—	132	160	203	—	—	150	3RW44 35-□BC□6
	281	—	160	200	251	—	—	200	3RW44 36-□BC□6
	352	—	200	250	312	—	—	250	3RW44 43-□BC□6
	433	—	250	315	372	—	—	300	3RW44 44-□BC□6
	542	—	315	355	485	—	—	400	3RW44 45-□BC□6
	617	—	355	450	546	—	—	450	3RW44 46-□BC□6
	748	—	400	500	667	—	—	600	3RW44 47-□BC□6
	<b>Order No. extension for connection method</b>							Spring-loaded terminals Screw-type terminals	↑ 2 ↑ 6
	<b>Order No. extension for rated control supply voltage <math>U_s</math></b>							115 V AC 230 V AC	3 4

9.3.2 Technical data power component

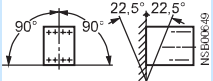
Type		3RW44 ...BC.4	3RW44 ...BC.5	3RW44 ...BC.6
<b>Power electronics</b>				
<b>Rated operating voltage for standard circuit</b>	V	AC 200 ... 460	AC 400 ... 600	AC 400 ... 690
Tolerance	%	-15/+10	-15/+10	-15/+10
<b>Rated operating voltage in inside delta circuit</b>	V	AC 200 ... 460	AC 400 ... 600	AC 400 ... 600
Tolerance	%	-15/+10	-15/+10	-15/+10
<b>Rated frequency</b>	Hz	50 ... 60		
Tolerance	%	±10		
<b>Continuous operation at 40 °C (% of I<sub>e</sub>)</b>	%	115		
<b>Minimum load (% of I<sub>e</sub>)</b>	%	20		
<b>Maximum cable length</b> between soft starter and motor	m	200		
<b>Permissible installation height</b>	m	3000 (derating from 1000); higher on request		
<b>Permissible mounting position</b>				
<b>Permissible ambient temperature</b>				
Operation	°C	0 ... +60; (derating from +40)		
Storage	°C	-25 ... +80		
<b>Degree of protection</b>		IP00		

Type		3RW44 22	3RW44 23	3RW44 24	3RW44 25	3RW44 26	3RW44 27
<b>Power electronics</b>							
<b>Rated operating current I<sub>e</sub></b>		29	36	47	57	77	93
<b>Current carrying capacity rated operating current I<sub>e</sub></b>							
• Acc. to IEC and UL/CSA for individual installation, at 40/50/60 °C, AC-53a	A	29/26/23	36/32/29	47/42/37	57/51/45	77/68/59	93/82/72
<b>Heat loss</b>							
• In operation after completed run up with continuous rated operating current (40 °C) approx.	W	8	10	32	36	45	55
• During starting with current limit set at 350 % I <sub>M</sub> (40 °C)	W	400	470	600	725	940	1160
<b>Permissible motor rated current and starts per hour</b>							
<b>• For normal starting (Class 5)</b>							
- Motor rated current I <sub>M</sub> <sup>1)</sup> , run-up time 5 s	A	29	36	47	57	77	93
- Starts per hour <sup>2)</sup>	1/h	41	34	41	41	41	41
- Motor rated current I <sub>M</sub> <sup>+1)3)</sup> , run-up time 10 s	A	29	36	47	57	77	93
- Starts per hour <sup>2)</sup>	1/h	20	15	20	20	20	20
<b>• For normal starting (Class 10)</b>							
- Motor rated current I <sub>M</sub> <sup>1)</sup> , run-up time 10 s	A	29	36	47	57	77	93
- Starts per hour <sup>2)</sup>	1/h	20	15	20	20	20	20
- Motor rated current I <sub>M</sub> <sup>+1)3)</sup> , run-up time 20 s	A	29	36	47	57	77	93
- Starts per hour <sup>2)</sup>	1/h	10	6	10	10	8	8
<b>• For normal starting (Class 15)</b>							
- Motor rated current I <sub>M</sub> <sup>1)</sup> , run-up time 15 s	A	29	36	47	57	77	93
- Starts per hour <sup>2)</sup>	1/h	13	9	13	13	13	13
- Motor rated current I <sub>M</sub> <sup>+1)3)</sup> , run-up time 30 s	A	29	36	47	57	77	93
- Starts per hour <sup>2)</sup>	1/h	6	4	6	6	6	6
<b>• For heavy starting (Class 20)</b>							
- Motor rated current I <sub>M</sub> <sup>1)</sup> , run-up time 20 s	A	29	36	47	57	73	88
- Starts per hour <sup>2)</sup>	1/h	10	6	10	10	10	10
- Motor rated current I <sub>M</sub> <sup>+1)3)</sup> , run-up time 40 s	A	29	36	47	57	73	88
- Starts per hour <sup>2)</sup>	1/h	4	2	4	5	1.8	0.8
<b>• For heaviest starting (Class 30)</b>							
- Motor rated current I <sub>M</sub> <sup>1)</sup> , run-up time 30 s	A	29	36	44	57	65	77
- Starts per hour <sup>2)</sup>	1/h	6	4	6	6	6	6
- Motor rated current I <sub>M</sub> <sup>+1)3)</sup> , run-up time 60 s	A	29	36	44	57	65	77
- Starts per hour <sup>2)</sup>	1/h	1.8	0.8	3.3	1.5	2	1
<b>Minimum configurable motor rated current I<sub>M</sub></b>	A	5	7	9	11	15	18

1) Current limiting at soft starter set to 350 % I<sub>M</sub>.

2) For intermittent operation S4 with On Time OT = 70 %, T<sub>u</sub> = 40 °C, individual vertical installation. The specified switching frequencies do not apply to automatic operation.

3) Maximum configurable motor rated current I<sub>M</sub>, depending on the Class setting.

## General technical data

Type		3RW44 34	3RW44 35	3RW44 36
<b>Power electronics</b>				
<b>Rated operating current <math>I_e</math></b>		113	134	162
<b>Current carrying capacity rated operating current <math>I_e</math></b>				
• Acc. to IEC and UL/CSA for individual installation, at 40/50/60 °C, AC-53a	A	113/100/88	134/117/100	162/145/125
<b>Heat loss</b>				
• In operation after completed run up with continuous rated operating current (40 °C) approx.	W	64	76	95
• During starting with current limit set at 350 % $I_M$ (40 °C)	W	1350	1700	2460
<b>Permissible motor rated current and starts per hour</b>				
<b>• For normal starting (Class 5)</b>				
- Motor rated current $I_M^{(1)}$ , run-up time 5 s	A	113	134	162
- Starts per hour <sup>2)</sup>	1/h	41	39	41
- Motor rated current $I_M^{+1(3)}$ , run-up time 10 s	A	113	134	162
- Starts per hour <sup>2)</sup>	1/h	20	15	20
<b>• For normal starting (Class 10)</b>				
- Motor rated current $I_M^{(1)}$ , run-up time 10 s	A	113	134	162
- Starts per hour <sup>2)</sup>	1/h	20	15	20
- Motor rated current $I_M^{+1(3)}$ , run-up time 20 s	A	113	134	162
- Starts per hour <sup>2)</sup>	1/h	9	6	7
<b>• For normal starting (Class 15)</b>				
- Motor rated current $I_M^{(1)}$ , run-up time 15 s	A	113	134	162
- Starts per hour <sup>2)</sup>	1/h	13	9	12
- Motor rated current $I_M^{+1(3)}$ , run-up time 30 s	A	113	134	162
- Starts per hour <sup>2)</sup>	1/h	6	6	6
<b>• For heavy starting (Class 20)</b>				
- Motor rated current $I_M^{(1)}$ , run-up time 20 s	A	106	125	147
- Starts per hour <sup>2)</sup>	1/h	9	9	10
- Motor rated current $I_M^{+1(3)}$ , run-up time 40 s	A	106	125	147
- Starts per hour <sup>2)</sup>	1/h	1.5	2	0.5
<b>• For heaviest starting (Class 30)</b>				
- Motor rated current $I_M^{(1)}$ , run-up time 30 s	A	91	110	120
- Starts per hour <sup>2)</sup>	1/h	6	6	6
- Motor rated current $I_M^{+1(3)}$ , run-up time 60 s	A	91	110	120
- Starts per hour <sup>2)</sup>	1/h	2	2	0.5
<b>Minimum configurable motor rated current <math>I_M</math></b>	A	22	26	32

1) Current limiting at soft starter set to 350 %  $I_M$ .

2) For intermittent operation S4 with On Time OT = 70 %,  $T_U = 40$  °C, individual vertical installation. The specified switching frequencies do not apply to automatic operation.

3) Maximum configurable motor rated current  $I_M$ , depending on the Class setting.

Type		3RW44 43	3RW44 44	3RW44 45	3RW44 46	3RW44 47
<b>Power electronics</b>						
<b>Rated operating current <math>I_e</math></b>		203	250	313	356	432
<b>Current carrying capacity rated operating current <math>I_e</math></b>						
• Acc. to IEC and UL/CSA for individual installation, at 40/50/60 °C, AC-53a	A	203/180/156	250/215/185	313/280/250	356/315/280	432/385/335
<b>Heat loss</b>						
• In operation after completed run up with continuous rated operating current (40 °C) approx.	W	89	110	145	174	232
• During starting with current limit set at 350 % $I_M$ (40 °C)	W	3350	4000	4470	5350	5860
<b>Permissible motor rated current and starts per hour</b>						
<b>• For normal starting (Class 5)</b>						
- Motor rated current $I_M^{1)}$ , run-up time 5 s	A	203	250	313	356	432
- Starts per hour <sup>2)</sup>	1/h	41	40	41	41	39
- Motor rated current $I_M^{+1)3)}$ , run-up time 10 s	A	203	250	313	356	432
- Starts per hour <sup>2)</sup>	1/h	20	20	20	17	16
<b>• For normal starting (Class 10)</b>						
- Motor rated current $I_M^{1)}$ , run-up time 10 s	A	203	250	313	356	432
- Starts per hour <sup>2)</sup>	1/h	20	20	20	17	16
- Motor rated current $I_M^{+1)3)}$ , run-up time 20 s	A	203	250	313	356	432
- Starts per hour <sup>2)</sup>	1/h	10	8	8	4	5
<b>• For normal starting (Class 15)</b>						
- Motor rated current $I_M^{1)}$ , run-up time 15 s	A	203	240	313	325	402
- Starts per hour <sup>2)</sup>	1/h	13	11	13	13	11
- Motor rated current $I_M^{+1)3)}$ , run-up time 30 s	A	203	240	313	325	402
- Starts per hour <sup>2)</sup>	1/h	6	6	6	6	6
<b>• For heavy starting (Class 20)</b>						
- Motor rated current $I_M^{1)}$ , run-up time 20 s	A	195	215	275	285	356
- Starts per hour <sup>2)</sup>	1/h	10	10	10	10	10
- Motor rated current $I_M^{+1)3)}$ , run-up time 40 s	A	195	215	275	285	356
- Starts per hour <sup>2)</sup>	1/h	4	1.5	3	3	1.8
<b>• For heaviest starting (Class 30)</b>						
- Motor rated current $I_M^{1)}$ , run-up time 30 s	A	162	180	220	240	285
- Starts per hour <sup>2)</sup>	1/h	6	6	6	6	6
- Motor rated current $I_M^{+1)3)}$ , run-up time 60 s	A	162	180	220	240	285
- Starts per hour <sup>2)</sup>	1/h	4.3	1.8	3	2	1.6
<b>Minimum configurable motor rated current <math>I_M</math></b>	A	40	50	62	71	86

1) Current limiting at soft starter set to 350 %  $I_M$ .

2) For intermittent operation S4 with On Time OT = 70 %,  $T_u = 40$  °C, individual vertical installation. The specified switching frequencies do not apply to automatic operation.

3) Maximum configurable motor rated current  $I_M$ , depending on the Class setting.

9.3.3 Technical data control section

Type	Terminal		3RW44 ...BC3.	3RW44 ...BC4.
<b>Control electronics</b>				
<b>Rated values</b>				
Rated control supply voltage	A1/A2/PE	V	AC 115	AC 230
• Tolerance		%	-15/+10	-15/+10
Rated control supply current STANDBY		mA	30	20
Rated control supply current ON				
• 3RW442.		mA	300	170
• 3RW443.		mA	500	250
• 3RW444.		mA	750	400
Maximum current (starting bypass)				
• 3RW442.		mA	1000	500
• 3RW443.		mA	2500	1250
• 3RW444.		mA	6000	3000
Rated frequency		Hz	50 ... 60	50 ... 60
• Tolerance		%	±10	±10

Type	Terminal		3RW44 ..	Factory setting
<b>Control electronics</b>				
<b>Control inputs</b>				
Input 1	IN1			Start motor right parameter set 1 No action No action Trip / Reset
Input 2	IN2			
Input 3	IN3			
Input 4	IN4			
Supply	L+/L-			
• Rated operating current		mA	Approx. 10 per input acc. to DIN 19240	
• Rated operating voltage	L+		Internal voltage: 24 V DC from internal supply via terminal L+ on IN1 ... IN4. Maximum load at L+ ca. 55 mA	
	L-		External voltage: DC external voltage (acc. to DIN 19240) via terminals L- and IN1 ... IN4 (min. 12 V DC, max. 30 V DC)	
<b>Thermistor motor protection input</b>				
Input	T1/T2		PTC Type A or Thermo click	Deactivated
<b>Relay outputs (floating auxiliary contacts)</b>				
Output 1	13/14			On time motor No action No action Group error
Output 2	23/24			
Output 3	33/34			
Output 4	95/96/98			
<b>Switching capacity of the relay outputs</b>				
230 V/AC-15		A	3 at 240 V	
24 V/DC-13		A	1 at 24 V	
Protection against overvoltages			Protection using varistor via relay contact	
Short-circuit protection			4 A utilization category gL/gG; 6 A quick (fuse not included in scope of delivery)	
<b>Protective functions</b>				
<b>Motor protection functions</b>				
Trip on			Thermal motor overload	10
Tripping class acc. to IEC 60947-4-1		Class	5/10/15/20/30	
Phase failure sensitivity		%	>40	
Overload warning			Yes	Manual Manual
Reset and recovery			Manual/automatic	
Reset option after trip			Manual/automatic	
Pre-charge time		min.	2 ... 30	2
<b>Device protection functions</b>				
Trip on			Thermal overloading of the thyristors	Manual
Reset option after trip			Manual/automatic	
Pre-charge time		min.	0,5	

Type	3RW44 ..		Factory setting
<b>Control times and parameters</b>			
<b>Control times</b>			
ON delay (with control voltage applied)	ms	<50	
ON delay (automatic operation)	ms	<4000	
Pre-charge time (switch-on command during active stopping)	ms	<100	
<b>Network failure bridging time</b>			
Control supply voltage	ms	100	
<b>Network failure reaction time</b>			
Load circuit	ms	100	
<b>Reclosing lockout after overload trip</b>			
Motor protection tripping	min.	1 ... 30	1
Device protection tripping	min.	0.5	
<b>Possible starting settings</b>			
Voltage ramp start voltage	%	20 ... 100	40
Torque control start torque	%	10 ... 100	50
Torque control limiting torque	%	20 ... 200	150
Starting time	s	0 ... 360	20
Maximum starting time	s	1 ... 1000	Deactivated
Current limiting value	%	125 ... 550	450
Breakaway voltage	%	40 ... 100	80
Breakaway time	s	0 ... 2	Deactivated
Motor thermal capacity	%	0 ... 100	0
<b>Slow speed mode counter-clockwise/ clockwise rotation</b>			
Speed factor in relation to nominal operating speed ( $n = n_{\text{nominal}}/\text{factor}$ )		3 ... 21	7
Slow torque (reference quantity depends on motor used, but in any case lower than the rated motor torque)	%	20 ... 100	50
<b>Possible stopping settings</b>			
Torque control stopping torque	%	10 ... 100	40
Stopping time	s	0 ... 360	10
Combined braking	%	20 ... 100	50
DC braking	%	20 ... 100	50
<b>Operational messages</b>			
		Check voltage Check line phases Ready to start  Starting is active Motor is running Stopping is active	
<b>Warning/error messages</b>			
		No line voltage Incorrect start condition Phase failure • L1 • L2 • L3 Load phase missing • T1 • T2 • T3 Failure • Contact block 1 (thyristor) • Contact block 2 (thyristor) • Contact block 3 (thyristor) Faulty flash memory Supply voltage • below 75 % • below 85 % • above 110 % Current asymmetry exceeded Thermal motor model overload Prewarning limit exceeded • Motor heat build-up • Remaining time for tripping Bypass elements defective Line overvoltage Current limits exceeded Motor stalling - tripping	







## General technical data

	<ul style="list-style-type: none"> <li>Current range exceeded</li> <li>Power component overheated</li> <li>Power component overtemperature</li> <li>Temperature sensor <ul style="list-style-type: none"> <li>- Overload</li> <li>- Wire break</li> <li>- Short circuit</li> </ul> </li> <li>Earth fault recognized</li> <li>Earth-fault tripping</li> <li>Connection break in manual operating mode</li> </ul>	
<b>Typ</b>	<b>3RW44 ..</b>	Factory setting
<b>Control times and parameters</b>		
<b>Control inputs</b> Input 1 Input 2 Input 3 Input 4 Parameterization options for control inputs 1 ... 4	No action Manual operation local Slow speed Trip / Reset Motor right parameter set 1 Motor left parameter set 1 <sup>1)</sup> Motor right parameter set 2 Motor left parameter set 2 <sup>1)</sup> Motor right parameter set 3 Motor left parameter set 3 <sup>1)</sup>	Motor right parameter set 1 No action No action Trip / Reset
<b>Relay outputs</b> Output 1 Output 2 Output 3 Output 4 Parameterization options for relay outputs 1 ... 3	No action PAA output 1 PAA output 2 Input 1 Input 2 Input 3 Input 4 Run up Bypass operation Stopping On time motor Motor ON command DC braking contactor Group warning Group error Device error Power on Ready to start	On time motor No action No action Group error
<b>Motor temperature sensor</b>	Deactivated Thermo click PTC type A	Deactivated

1) Motor left parameter possible only in combination with slow speed mode.



### 9.3.4 Conductor cross-sections

Type		3RW44 2.	3RW44 3., 3RW44 4.
<b>Conductor cross-sections</b>			
<b>Screw-type terminals with box terminal</b>	<b>Main conductor:</b>		
<b>Front terminal connected</b>	<ul style="list-style-type: none"> <li>Finely stranded with end sleeve</li> <li>Finely stranded without end sleeve</li> <li>Stranded</li> <li>Ribbon conductor (number x width x thickness)</li> <li>AWG wires, solid or stranded</li> </ul>	mm <sup>2</sup> 16 ... 70 mm <sup>2</sup> 16 ... 70 mm <sup>2</sup> 16 ... 70 mm min. 3 x 9 x 0.8, max. 6 x 15.5 x 0.8 AWG 6 ... 2/0	3RT19 55-4G (55 kW) 3RT19 66-4G 70 ... 240 70 ... 240 95 ... 300 min. 6 x 9 x 0.8 max. 20 x 24 x 0.5 3/0 ... 600 kcmil
 NSB00479			
<b>Rear terminal connected</b>	<ul style="list-style-type: none"> <li>Finely stranded with end sleeve</li> <li>Finely stranded without end sleeve</li> <li>Stranded</li> <li>Ribbon conductor (number x width x thickness)</li> <li>AWG wires, solid or stranded</li> </ul>	mm <sup>2</sup> 16 ... 70 mm <sup>2</sup> 16 ... 70 mm <sup>2</sup> 16 ... 70 mm min. 3 x 9 x 0.8, max. 6 x 15.5 x 0.8 AWG 6 ... 2/0	120 ... 185 120 ... 185 120 ... 240 min. 6 x 9 x 0.8 max. 20 x 24 x 0.5 250 ... 500 kcmil
 NSB00482			
<b>Both terminals connected</b>	<ul style="list-style-type: none"> <li>Finely stranded with end sleeve</li> <li>Finely stranded without end sleeve</li> <li>Stranded</li> <li>Ribbon conductor (number x width x thickness)</li> <li>AWG wires, solid or stranded</li> <li>Connecting screws - Tightening torque</li> </ul>	mm <sup>2</sup> max. 1 x 50, 1 x 70 mm <sup>2</sup> max. 1 x 50, 1 x 70 mm <sup>2</sup> max. 2 x 70 mm max. 2 x (6 x 15.5 x 0.8) AWG max. 2 x 1/0 M10 (Allen, SW4) 10 ... 12 90 ... 110	min. 2 x 50; max. 2 x 185 min. 2 x 50; max. 2 x 185 max. 2 x 70; max. 2 x 240 max. 2 x (20 x 24 x 0.5) min. 2 x 2/0; max. 2 x 500 kcmil M12 (Allen, SW5) 20 ... 22 180 ... 195
 NSB00481			
<b>Screw-type terminals with box terminal</b>	<b>Main conductor:</b>		
<b>Front or rear terminal connected</b>	<ul style="list-style-type: none"> <li>Finely stranded with end sleeve</li> <li>Finely stranded without end sleeve</li> <li>Stranded</li> <li>Ribbon conductor (number x width x thickness)</li> <li>AWG wires, solid or stranded</li> </ul>	mm <sup>2</sup> 16 ... 120 mm <sup>2</sup> 16 ... 120 mm <sup>2</sup> 16 ... 120 mm min. 3 x 9 x 0.8 max. 6 x 15.5 x 0.8 AWG 6 ... 250 kcmil	3RT19 56-4G
 NSB00479			
 NSB00480			
<b>Both terminals connected</b>	<ul style="list-style-type: none"> <li>Finely stranded with end sleeve</li> <li>Finely stranded without end sleeve</li> <li>Stranded</li> <li>Ribbon conductor (number x width x thickness)</li> <li>AWG wires, solid or stranded</li> </ul>	mm <sup>2</sup> max. 1 x 95, 1 x 120 mm <sup>2</sup> max. 1 x 95, 1 x 120 mm <sup>2</sup> max. 2 x 120 mm max. 2 x (10 x 15.5 x 0.8) AWG max. 2 x 3/0	
 NSB00481			
<b>Screw-type terminals</b>	<b>Main conductor:</b>		
	<u>Without box terminal/busbar connection</u>		
	<ul style="list-style-type: none"> <li>Finely stranded with cable lug</li> <li>Stranded with cable lug</li> <li>AWG wires, solid or stranded</li> <li>Connecting bar (max. width)</li> <li>Connecting screws - Tightening torque</li> </ul>	mm <sup>2</sup> 16 ... 95 <sup>1)</sup> mm <sup>2</sup> 25 ... 120 <sup>1)</sup> AWG 4 ... 250 kcmil mm 17 M8 x 25 (SW13) Nm 10 ... 14 lb.in 89 ... 124	50 ... 240 <sup>2)</sup> 70 ... 240 <sup>2)</sup> 2/0 ... 500 kcmil 25 M10 x 30 (SW17) 14 ... 24 124 ... 210

1) When connecting cable lugs acc. to DIN 46235 from a conductor with a cross-section of 95 mm<sup>2</sup>, the 3RT19 56-4EA1 terminal cover is required to ensure phase clearance.  
 2) When connecting cable lugs acc. to DIN 46234 from a conductor with a cross-section of 240 mm<sup>2</sup> as well as DIN 46235 from a conductor cross-section of 185 mm<sup>2</sup>, the 3RT19 66-4EA1 terminal cover is required to ensure phase clearance.

## General technical data

Soft starters	Type	3RW44 ..	
<b>Conductor cross-sections</b>			
<b>Auxiliary conductor</b> (1 or 2 conductors can be connected):			
<b>Screw-type terminals</b>			
• solid	mm <sup>2</sup>	2 x 0.5 ... 2.5	
• Finely stranded with end sleeve	mm <sup>2</sup>	2 x 0.5 ... 1.5	
• AWG conductors			
- solid or stranded	AWG	2 x 20 ... 14	
- Finely stranded with end sleeve	AWG	2 x 20 ... 16	
• Connecting screws			
- Tightening torque	Nm lb.in	0.7 ... 0.9 7 ... 8	
<b>Spring-loaded terminals</b>			
• solid	mm <sup>2</sup>	2 x 0.25 ... 2.5	
• Finely stranded with end sleeve	mm <sup>2</sup>	2 x 0.25 ... 1.5	
• AWG wires, solid or stranded	AWG	2 x 24 ... 14	

### 9.3.5 Electromagnetic compatibility

	Standard	Parameters
<b>Electromagnetic compatibility acc. to EN 60947-4-2</b>		
<i>EMC interference immunity</i>		
<b>Electrostatic discharge (ESD)</b>	EN 61000-4-2	±4 kV contact discharge, ±8 kV air discharge
<b>Electromagnetic HF fields</b>	EN 61000-4-3	Frequency range: 80 ... 1000 MHz with 80 % at 1 kHz Severity 3, 10 V/m
<b>Conducted HF interference</b>	EN 61000-4-6	Frequency range: 150 kHz ... 80 MHz with 80 % at 1 kHz Interference 10 V
<b>HF voltages and HF currents on lines</b>		
Burst	EN 61000-4-4	±2 kV/5 kHz
Surge	EN 61000-4-5	±1 kV line to line ±2 kV line to ground
<i>EMC interference emission</i>		
<b>EMC interference field strength</b>	EN 55011	Class A limit value at 30 ... 1000 MHz
<b>Radio interference voltage</b>	EN 55011	Class A limit value at 0.15 ... 30 MHz
<i>Is a radio interference suppression filter required?</i>		
<b>Radio interference suppression level A</b> (industrial applications)	None	

9.3.6 Branch component layout (standard circuit)

Branch component layout (standard circuit)										
Soft starter	Nominal current Soft starter	Circuit breaker		Conductor protection fuse			Full-range fuse			
G1 Type	A	Q1 Type	Current A	F1 Type	Size	Current A	F1' Type	Size	Current A	Voltage V
3RW44 22	29	3RV10 42-4HA10	50	3NA3 820-6	00	50	3NE1 020-2	00	80	690 +5 %
3RW44 23	36	3RV10 42-4JA10	63	3NA3 822-6	00	63	3NE1 020-2	00	80	690 +5 %
3RW44 24	47	3RV10 42-4KA10	75	3NA3 824-6	00	80	3NE1 021-2	00	100	690 +5 %
3RW44 25	57	3RV10 42-4LA10	90	3NA3 830-6	00	100	3NE1 022-2	00	125	690 +5 %
3RW44 26	77	3RV10 42-4MA10	100	3NA3 132-6	1	125	3NE1 022-2	00	125	690 +5 %
3RW44 27	93	3RV10 42-4MA10	100	3NA3 136-6	1	160	3NE1 224-2	1	160	690 +5 %
3RW44 34	113	3VL17 16-2DD36	160	3NA3 244-6	2	250	3NE1 225-2	1	200	690 +5 %
3RW44 35	134	3VL17 16-2DD36	160	3NA3 244-6	2	250	3NE1 227-2	1	250	690 +5 %
3RW44 36	162	3VL37 25-2DC36	250	3NA3 365-6	3	500	3NE1 227-2	1	250	690 +5 %
3RW44 43	203	3VL47 31-3DC36	315	2 x 3NA3 354-6	3	2 x 355	3NE1 230-2	1	315	600 +10 %
3RW44 44	250	3VL47 31-3DC36	315	2 x 3NA3 354-6	3	2 x 355	3NE1 331-2	2	350	460 +10 %
3RW44 45	313	3VL47 40-3DC36	400	2 x 3NA3 365-6	3	2 x 500	3NE1 333-2	2	450	690 +5 %
3RW44 46	356	3VL47 40-3DC36	400	2 x 3NA3 365-6	3	2 x 500	3NE1 334-2	2	500	690 +5 %
3RW44 47	432	3VL57 50-3DC36	500	2 x 3NA3 365-6	3	2 x 500	3NE1 435-2	3	560	690 +5 %

Branch component layout (standard circuit)										
Soft starter	Nominal current Soft starter	Semiconductor fuse, minimum			Semiconductor fuse, maximum			Line contactor up to 400 V (option)	Braking contactor <sup>1)2)</sup>	
G1 Type	A	F3 Type	Size	Current A	F3 Type	Size	Current A	K1/K1A Type	K2 Type	K3 Type
3RW44 22	29	3NE4 120	0	80	3NE4 121	0	100	3RT10 34	3RT15 26	—
3RW44 23	36	3NE4 121	0	100	3NE4 122	0	125	3RT10 35	3RT15 26	—
3RW44 24	47	3NE4 121	0	100	3NE4 122	0	125	3RT10 36	3RT15 35	—
3RW44 25	57	3NE4 122	0	125	3NE4 124	0	160	3RT10 44	3RT15 35	—
3RW44 26	77	3NE4 124	0	160	3NE4 124	0	160	3RT10 45	3RT10 24	3RT10 35
3RW44 27	93	3NE3 224	1	160	3NE3 333	2	450	3RT10 46	3RT10 25	3RT10 36
3RW44 34	113	3NE3 225	1	200	3NE3 335	2	560	3RT10 54	3RT10 34	3RT10 44
3RW44 35	134	3NE3 225	1	200	3NE3 335	2	560	3RT10 55	3RT10 36	3RT10 45
3RW44 36	162	3NE3 227	1	250	3NE3 333	2	450	3RT10 56	3RT10 44	3RT10 45
3RW44 43	203	3NE3 230-0B	1	315	3NE3 333	2	450	3RT10 64	3RT10 44	3RT10 54
3RW44 44	250	3NE3 230-0B	1	315	3NE3 333	2	450	3RT10 65	3RT10 44	3RT10 55
3RW44 45	313	3NE3 233	1	450	3NE3 336	2	630	3RT10 75	3RT10 54	3RT10 56
3RW44 46	356	3NE3 333	2	450	3NE3 336	2	630	3RT10 75	3RT10 54	3RT10 56
3RW44 47	432	3NE3 335	2	560	3NE3 338-8	2	800	3RT10 76	3RT10 55	3RT10 64



- 1) If the "combined braking" stopping function is selected, no brake contactor is necessary.  
If the "DC braking" stopping function is selected, a brake contactor must be additionally used (refer to table for types).  
The "DC braking" function is recommended for applications with larger centrifugal masses ( $J_{load} > J_{motor}$ ).
- 2) Additional K4 auxiliary relay, for device type 3RW44 26 and larger:  
LZX:RT4A4T30  
(3RW44 soft starter with 230 V AC rated control supply voltage),  
LZX:RT4A4S15  
(3RW44 soft starter with 115 V AC rated control supply voltage).

9.3.7 Branch component layout (inside delta circuit)

Branch component layout (inside delta circuit)						
Soft starter G1 Type	Nominal current Soft starter A	Circuit breaker Q1 Type		Conductor protection fuse F1 Type		
		440 V + 10 % Type	Current A	690 V + 5 % Type	Size	Current A
3RW44 22	50	3RV10 42-4KA10	75	3NA3 824-6	00	80
3RW44 23	62	3RV10 42-4LA10	90	3NA3 830-6	00	100
3RW44 24	81	3RV10 42-4MA10	100	3NA3 132-6	1	125
3RW44 25	99	3VL27 16-2DC36	160	3NA3 136-6	1	160
3RW44 26	133	3VL27 16-2DC36	160	3NA3 240-6	2	200
3RW44 27	161	3VL37 20-2DC36	200	3NA3 244-6	2	250
3RW44 34	196	3VL37 25-2DC36	250	3NA3 360-6	3	400
3RW44 35	232	3VL47 31-3DC36	315	3NA3 360-6	3	400
3RW44 36	281	3VL47 40-3DC36	400	2 x 3NA3 360-6	3	2 x 400
3RW44 43	352	3VL47 40-3DC36	400	2 x 3NA3 365-6	3	2 x 500
3RW44 44	433	3VL57 50-3DC36	500	2 x 3NA3 365-6	3	2 x 500
3RW44 45	542	3WL12 08-.EB.-.....	800	3 x 3NA3 365-6	3	3 x 500
3RW44 46	617	3WL12 08-.EB.-.....	800	3 x 3NA3 365-6	3	3 x 500
3RW44 47	748	3WL12 10-.EB.-.....	1000	3 x 3NA3 365-6	3	3 x 500

Branch component layout (inside delta circuit)								
Soft starter G1 Type	Nominal current Soft starter A	Semiconductor fuse, minimum F3			Semiconductor fuse, maximum F3			Line contactor up to 400 V (option) K1 Type
		Type	Size	Current A	Type	Size	Current A	
3RW44 22	50	3NE4 120	0	80	3NE4 121	0	100	3RT10 36-1AP04
3RW44 23	62	3NE4 121	0	100	3NE4 122	0	125	3RT10 44-1AP04
3RW44 24	81	3NE4 121	0	100	3NE4 122	0	125	3RT10 46-1AP04
3RW44 25	99	3NE4 122	0	125	3NE4 124	0	160	3RT10 54-1AP36
3RW44 26	133	3NE4 124	0	160	3NE4 124	0	160	3RT10 55-6AP36
3RW44 27	161	3NE3 224	1	160	3NE3 333	2	450	3RT10 56-6AP36
3RW44 34	196	3NE3 225	1	200	3NE3 335	2	560	3RT10 64-6AP36
3RW44 35	232	3NE3 225	1	200	3NE3 335	2	560	3RT10 65-6AP36
3RW44 36	281	3NE3 227	1	250	3NE3 333	2	450	3RT10 66-6AP36
3RW44 43	352	3NE3 230-0B	1	315	3NE3 333	2	450	3RT10 75-6AP36
3RW44 44	433	3NE3 230-0B	1	315	3NE3 333	2	450	3RT10 76-6AP36
3RW44 45	542	3NE3 233	1	450	3NE3 336	2	630	3TF68 44-OCM7
3RW44 46	617	3NE3 333	2	450	3NE3 336	2	630	3TF68 44-OCM7
3RW44 47	748	3NE3 335	2	560	3NE3 338-8	2	800	3TF69

### 9.3.8 Accessories

For soft starters Type	Version	Order No.	
<b>Box terminal block for soft starters</b>			
	<b>Box terminal block</b> 3RW44 2. included in scope of delivery 3RW44 3. <ul style="list-style-type: none"> <li>• Up to 70 mm<sup>2</sup></li> <li>• Up to 120 mm<sup>2</sup></li> </ul> 3RW44 3. <ul style="list-style-type: none"> <li>• Up to 240 mm<sup>2</sup></li> </ul>	<b>3RT19 55-4G</b> <b>3RT19 56-4G</b> <b>3RT19 66-4G</b>	
	<b>Covers for soft starters</b>		
		<b>Terminal cover for box terminals</b> Additional touch guard for box terminal mounting (two pieces required per unit) 3RW44 2. and 3RW44 3. 3RW44 4.	<b>3RT19 56-4EA2</b>  <b>3RT19 66-4EA2</b>
<b>Connection cover for cable lug and bar connection</b>			
3RW44 2. and 3RW44 3. 3RW44 4.		<b>3RT19 56-4EA1</b>  <b>3RT19 66-4EA1</b>	

### Software

Software	Order No.
<b>Selection and simulation software</b> Win-SOFTSTARTER <b>Parameterization and diagnostics software:</b> SOFTSTARTER ES smart SOFTSTARTER ES professional	<b>E20001-D1020-P302-V2-7400</b>  <b>3ZS1 313-1CC10-0YA0</b> <b>3ZS1 313-2CC10-0YA0</b>

### Components

For soft starters Type	Version	Order No.
<b>Fans</b>		
	3RW44 2. and 115 V AC 3RW44 3. 230 V AC 3RW44 4. 115 V AC 230 V AC	<b>3RW49 36-8VX30</b> <b>3RW49 36-8VX40</b> <b>3RW49 47-8VX30</b> <b>3RW49 47-8VX40</b>

## 9.4 Tripping characteristics

### 9.4.1 Motor protection tripping characteristics: 3RW44 with symmetry

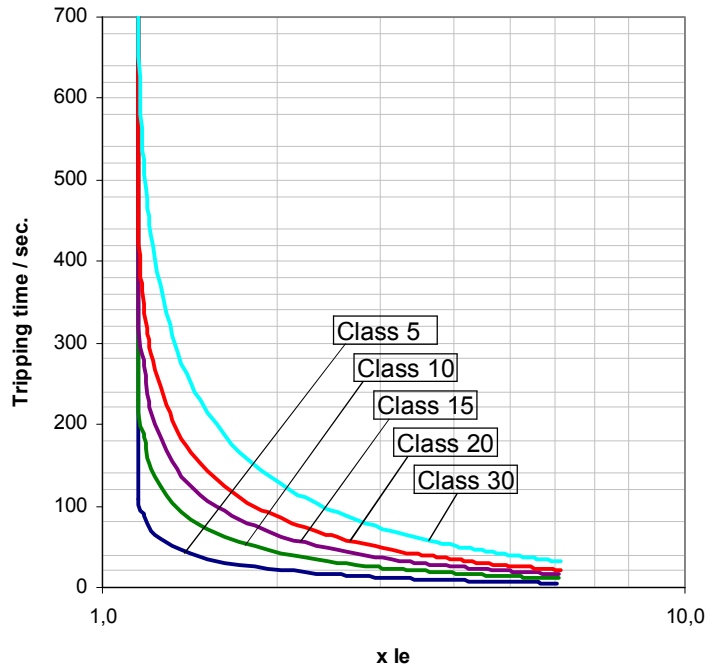

### 9.4.2 Motor protection tripping characteristics: 3RW44 with asymmetry

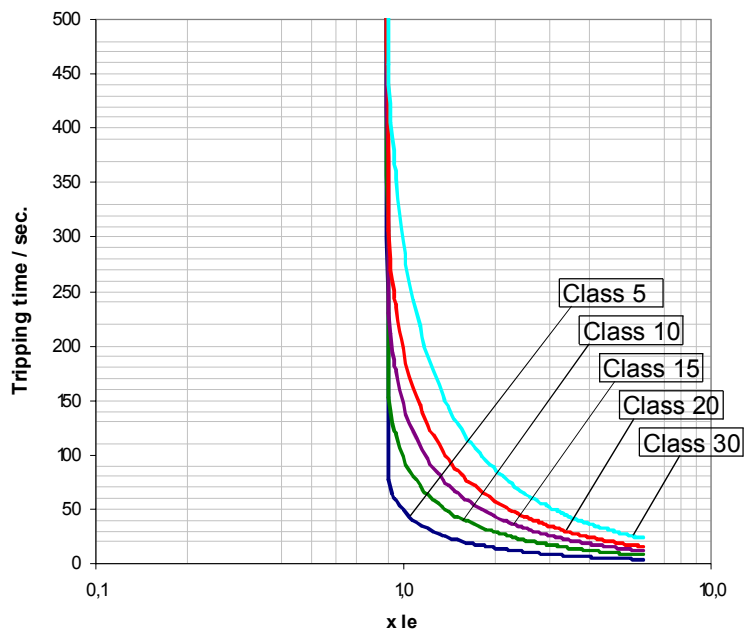

## 9.5 Dimension drawings

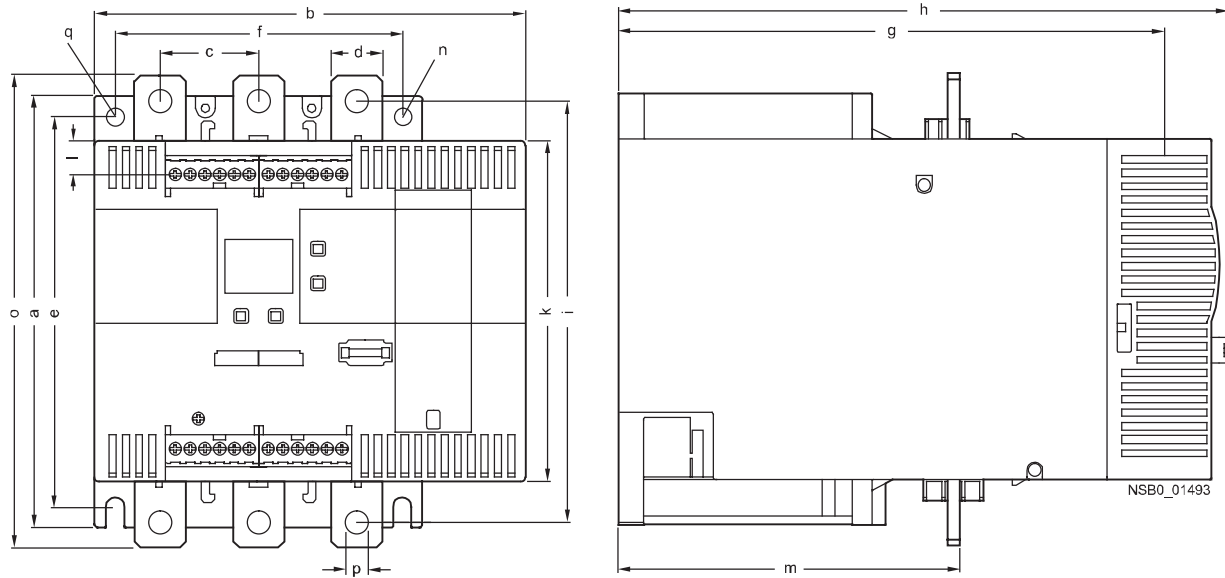

Type/dim. (mm)	a	b	c	d	e	f	g	h	i	k	l	m	n	o	p	q
<b>3RW44 2.</b>	180	170	37	11	167	100	240	270	180	148	7.5	153	7	184	6.6	M6, 10 Nm
<b>3RW44 3.</b>	180	170	37	17	167	100	240	270	180	148	7.5	153	7	198	9	M6, 10 Nm
<b>3RW44 4.</b>	210	210	48	25	190	140	269	298	205	166	16	166	9	230	11	M8, 15 Nm





# Index

## Numerics

3-phase asynchronous motors 1-2, 6-19  
3RW44 2. 3-11  
3RW44 22 8-4  
3RW44 25 8-4  
3RW44 26 8-5  
3RW44 3. 3-11  
3RW44 4. 3-11  
3RW44 47 8-5

## A

Accessories 9-17  
Ambient temperature 2-6  
Applications 1-7, 6-2, 6-6  
Asymmetric limit value 6-19  
Asymmetry 6-19, 9-18  
Atmospheric pressure 9-4  
Automatic restart 3-4

## B

Box terminal block for soft starters 9-17  
Branch layout 3-4  
Breakaway pulse 6-7  
Breakaway time 6-7  
Breakaway voltage 6-7

## C

Capacitor 3-10  
Class 10 2-3, 6-20, 9-7, 9-8, 9-9  
Class 10A 6-20  
Class 15 9-7, 9-8, 9-9  
Class 20 9-7, 9-8, 9-9  
Class 30 9-7, 9-8, 9-9  
Class 5 9-7, 9-8, 9-9  
Class setting 6-18, 9-7, 9-8, 9-9  
Clearances 3-3  
Coasting down 2-3, 2-4, 5-16, 6-11  
Combined braking 5-18, 6-13  
Component layout 9-15  
Conductor cross-sections 3-12, 9-13  
Configuration 2-2  
Connection examples 8-2  
Connections 3-11  
Contact block 3-4  
Control circuit 8-2  
Control electronics 9-10  
Control inputs 9-12  
Control times 9-11  
Control voltage versions 3-10  
Covers for soft starters 9-17  
Current asymmetry limit value 6-19  
Current limit value 6-9  
Current limit values 5-19, 6-17

Current limiting 6-9

## D

DC braking 5-18, 6-13, 6-14, 8-4, 8-5  
DC braking torque 6-13, 6-14  
Degree of protection 3-2  
Device errors 7-4  
Device interface 4-3  
Diagnostics 7-2  
Dimension drawings 9-19  
Direct on-line starting 5-15  
Disconnecter 3-4  
Display 4-2  
Display settings 5-23  
Dynamic braking torque 6-13

## E

Earth fault 7-4  
Electromagnetic compatibility 9-14  
Error 7-2  
Error messages 7-2  
Example applications 2-3

## F

Factory setting 2-7  
Fans 9-17

## G

Group error 7-2

## H

Heaviest starting 2-4, 9-7, 9-8, 9-9  
Heavy starting 2-3, 9-7, 9-8, 9-9

## I

Idle time 6-19, 6-20  
Inching 6-19  
Inherent protection 6-22  
Inside delta circuit 3-6, 8-6  
Installation height 2-6  
Internal run-up recognition 6-3, 6-5

## L

Limiting torque 6-5  
Line contactor 8-3

## M

Main circuit 8-2  
Main contactor 3-8  
Main current connection 3-11  
Measured value display 5-28  
Menu structure 5-2, 9-2  
Messages 7-2

---

Motor control 5-30  
 Motor data 5-9  
 Motor heat build-up 6-19  
 Motor heating 5-15, 6-10  
 Motor overload protection 6-18  
 Motor protection function 6-18  
 Motor protection settings 5-22  
 Mounting dimensions 3-3  
 Mounting position 3-2

**N**

Navigation 5-2  
 Normal or heavy starting 2-3  
 Normal starting 2-3, 9-7, 9-8, 9-9

**O**

On-time 2-5  
 Overtemperature 7-3

**P**

Parameter sets 5-8, 6-2  
 Parameterization of the inputs 5-20  
 Parameterization of the outputs 5-20  
 Parameters 5-2  
 PC interface 2-2  
 Phase failure 7-2  
 PLC 8-3  
 Power electronics 9-9  
 Prewarning limit 6-19  
 Profibus 4-3  
 Profibus interface 4-3  
 Protection against voltage failure 6-20  
 Protective functions 5-24, 9-10  
 PTC thermistors 6-21  
 Pump stop 5-17, 6-12

**Q**

Quick start menu 5-4, 5-5

**R**

Rated motor current 3-6  
 Rated rotational speed 6-16  
 Rated torque 5-9  
 Reduce starting current 1-2  
 Relative humidity 9-4  
 Relay outputs 9-12  
 Restart 3-4  
 Reversed direction of rotation 8-6  
 Reversing operation 8-9  
 Run-up recognition 6-3, 6-5, 6-9, 6-10

**S**

Safety 5-30  
 Saving options 5-25

Screw-type connection 3-10  
 Screw-type terminals 9-13  
 Selection criteria 1-7  
 Semiconductor fuse 3-9  
 Settings 5-7, 5-25, 5-26  
 SITOR fuse 3-9  
 Slow speed factor 6-16  
 Slow speed function 6-16, 8-8  
 Slow speed parameters 5-19  
 Slow torque 6-16  
 Soft stop 5-17  
 Software 2-2, 4-3, 9-17  
 Spring-loaded terminals 3-10  
 Standard circuit 3-5, 8-2  
 Standards 3-2  
 Start torque 1-2, 1-4, 6-3, 6-5, 6-7  
 Start voltage 6-3  
 Starting 1-6  
 Starting current 1-2  
 Starting mode 5-10  
 Starting time 6-3, 6-5  
 Status diagram 5-21  
 Status display 5-29  
 Stopping modes 5-16, 6-11  
 Stopping time 6-12, 6-14, 6-15  
 Stopping torque 6-12  
 Storage temperature 9-4  
 Supply voltage 3-6, 7-3  
 Switching frequency 2-5  
 Symmetry 9-18

**T**

Technical data 9-5  
 Technical data control section 9-10  
 Technical data power component 9-7  
 Temperature 9-4  
 Temperature sensor 6-21  
 Thermo click 6-21  
 Torque control 5-13, 5-17, 6-5  
 Torque control with current limiting 5-14  
 Transport and storage conditions 9-4  
 Tripping characteristics 9-18  
 Tripping class 6-18, 6-19

**U**

Unpacking 3-2  
 User-specific commissioning 5-6

**V**

Voltage ramp 5-11, 6-3, 6-4  
 Voltage ramp and current limiting 5-12

**W**

Warnings 7-2

To  
SIEMENS AG  
A&D CD MM 3

92220 Amberg, Germany

Fax: 09621 / 80-3337

Sender (please fill in)
Name
Company / department
Address
Telephone
Fax

**SIRIUS 3RW44 soft starter manual**

Have you noticed any errors while reading this manual?  
Please use this form to inform us about any errors.  
All complaints and suggestions for improvements are very welcome.

.....

.....

.....

.....

.....

.....

.....

.....

.....

.....

.....

.....

.....

.....

.....

.....

.....

.....

.....

.....

.....

.....

.....

